

AlterMundus

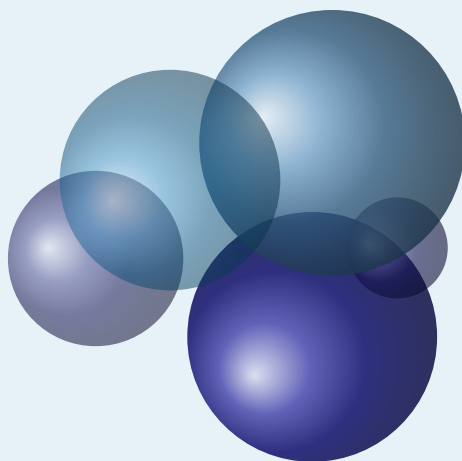

tkz-elements 3.32c

Euclidean Geometry



Alain Matthes

February 26, 2025 Documentation V3.32c

<http://altermundus.fr>

tkz-elements

AlterMundus

Alain Matthes

This document compiles some notes about **tkz-elements**, the initial version of a Lua library designed to perform all the necessary calculations for defining objects in Euclidean geometry figures. Your document must be compiled using Lua \LaTeX .

With **tkz-elements**, definitions and calculations are exclusively conducted using Lua.

The main programming approach provided is object-oriented, utilizing object classes such as point, line, triangle, and conic. Currently, after the calculations are completed, **tkz-euclide** is used for drawing purposes. (but you can also use TikZ)

I discovered Lua and object-oriented programming while developing this package, so it's highly likely that I've made a few mistakes. If you'd like to contribute to the development of this package or provide advice on how to proceed, please contact me via email.

☞ Acknowledgements : I received much valuable advices, remarks, corrections from Nicolas Kisselhoff, David Carlisle, Roberto Giacomelli and Qrrbrbirlbel. Special thanks to Wolfgang Büchel for his invaluable contribution in correcting the examples.

☞ I would also like to extend my gratitude to Eric Weisstein, creator of [MathWorld](#).

☞ You can find some examples on my site and a french documentation: [altermundus.fr](#).

Please report typos or any other comments to this documentation to: [Alain Matthes](#).

This file can be redistributed and/or modified under the terms of the \LaTeX Project Public License Distributed from [CTAN](#) archives.

Contents

1	News	11
2	Structure	11
3	Why tkz-elements?	13
3.1	Calculation accuracy	13
3.1.1	Calculation accuracy in TikZ	13
3.1.2	Calculation accuracy in Lua	13
3.1.3	Using objects	13
3.1.4	Example: Apollonius circle	13
4	Presentation	16
4.1	With Lua	16
4.2	The main process	16
4.3	Complete example: Pappus circle	18
4.3.1	The figure	18
4.3.2	The code	18
4.4	Another example with comments: South Pole	19
5	Writing Convention	21
5.1	Miscellaneous	21
5.2	Assigning a Name to a Point	21
5.3	Assigning a Name to Other Objects	22
5.4	Writing conventions for attributes, methods.	22
6	Work organization	22
6.1	Scale problem	23
6.2	Code presentation	23
7	Transfers	24
7.1	From Lua to tkz-euclide or TikZ	24
7.1.1	Points transfer	24
7.1.2	Other transfers	25
7.1.3	Example 1	25
7.1.4	Example 2	26
7.1.5	Example 3	27
7.1.6	Example 4	27
7.1.7	Example 5	28
8	Class and object	29
8.1	Class	29
8.2	Object	29
8.2.1	Attributes	29
8.2.2	Methods	29
9	Class point	30
9.1	Attributes of a point	30
9.1.1	Example: point attributes	31
9.1.2	Attribute <code>mtx</code>	31
9.1.3	Argand diagram	32
9.2	Methods of the class point	33
9.2.1	Method <code>north (d)</code>	33
9.2.2	Method <code>polar</code>	33
9.2.3	Method <code>normalize ()</code>	34
9.2.4	Method <code>orthogonal (d)</code>	34

9.2.5	Method at	34
9.2.6	Method rotation first example	35
9.2.7	Method rotation second example	35
9.2.8	Method symmetry	36
10	Class line	37
10.1	Attributes of a line	37
10.1.1	Example: attributes of class line	37
10.1.2	Method new and line attributes	38
10.2	Methods of the class line	39
10.2.1	Method distance	40
10.2.2	Method in_out	41
10.2.3	Method in_in_out_segment	42
10.2.4	Method is_parallel	42
10.2.5	Method is_orthogonal	43
10.2.6	Method is_equidistant	43
10.2.7	Method report	43
10.2.8	Method two_angles	44
10.2.9	Method isosceles	44
10.2.10	Methods sss, sas, ssa	44
10.2.11	Triangle with side between side and angle	45
10.2.12	About sacred triangles	45
10.2.13	Method point	46
10.2.14	Method colinear_at	46
10.2.15	Method normalize	47
10.2.16	Method barycenter	47
10.2.17	Method ll_from	48
10.2.18	Method ortho_from	48
10.2.19	Method mediator	48
10.2.20	Method swap_line	49
10.2.21	Method equilateral	49
10.2.22	Method projection	50
10.2.23	Method projection_ll	50
10.2.24	Method affinity	50
10.2.25	Example: combination of methods	51
10.2.26	Method translation	52
10.2.27	Method reflection of an object	52
10.2.28	Method distance	53
10.2.29	Method apollonius (Apollonius circle $MA/MB = k$)	53
10.2.30	Method c_l_pp	54
10.2.31	Method c_ll_p	57
11	Class circle	59
11.1	Attributes of a circle	59
11.1.1	Example: circle attributes	59
11.1.2	Attributes perimeter and area	60
11.2	Methods of the class circle	61
11.2.1	Method new	61
11.2.2	Method radius	62
11.2.3	Method diameter	62
11.2.4	Method is_tangent	63
11.2.5	Method antipode	63
11.2.6	Method midarc	63
11.2.7	Method point (r)	64
11.2.8	Method inversion (obj): point, line and circle	64
11.2.9	Method internal_similitude	66

11.2.10	Method <code>external_similarity</code>	67
11.2.11	Method <code>radical_center</code> (C_1, C_2)	68
11.2.12	Method <code>radical_axis</code> (C)	69
11.2.13	Methods <code>tangent_at</code> (P) and <code>tangent_from</code> (P)	71
11.2.14	Method <code>commun_tangent</code> : Angle of two intersecting circles	71
11.2.15	Method <code>polar</code> (pt)	72
11.2.16	Method <code>orthogonal_from</code> (pt)	73
11.2.17	Method <code>orthogonal_through</code>	74
11.2.18	Method <code>mmidcircle</code>	74
11.2.19	Method <code>radical_circle</code>	77
11.2.20	Method <code>power</code> (pt)	79
11.2.21	In_out of a disk	79
11.2.22	Method <code>in_out</code> for circle and disk	80
11.2.23	Method <code>circles_position</code>	80
11.2.24	Method <code>c_c_pp</code>	81
11.2.25	Method <code>c_cc_p</code>	83
11.2.26	Method <code>c_lc_p</code>	85
12	Class <code>triangle</code>	86
12.1	Attributes of a triangle	86
12.2	Triangle attributes: angles	86
12.2.1	Example: triangle attributes	87
12.3	Methods of the class <code>triangle</code>	88
12.3.1	Method <code>gergonne_point</code>	89
12.3.2	Method <code>Nagel_point</code>	90
12.3.3	Method <code>mittenpunkt</code>	90
12.3.4	Method <code>projection</code>	91
12.3.5	Method <code>kimberling</code>	92
12.3.6	Method <code>trilinear</code>	93
12.3.7	Method <code>barycentric_coordinates</code>	93
12.3.8	Method <code>base</code>	94
12.3.9	Method <code>euler_points</code>	94
12.3.10	Method <code>nine_points</code>	95
12.3.11	Method <code>altitude</code>	96
12.3.12	Method <code>bisector</code>	96
12.3.13	Method <code>euler_circle</code>	97
12.3.14	Method <code>circum_circle</code>	97
12.3.15	Method <code>in_circle</code>	98
12.3.16	Method <code>ex_circle</code>	99
12.3.17	Method <code>spieker_circle</code>	100
12.3.18	Methods <code>cevian</code> and <code>cevian_circle</code>	100
12.3.19	Methods <code>pedal</code> and <code>pedal_circle</code>	101
12.3.20	Methods <code>conway_points</code> and <code>conway_circle</code>	102
12.3.21	Methods <code>bevan_circle</code> and <code>bevan_point</code>	103
12.3.22	Method <code>feuerbach</code> and method <code>feuerbach_point</code>	103
12.3.23	Method <code>similar</code>	104
12.3.24	Method <code>medial</code>	104
12.3.25	Method <code>incentral</code>	105
12.3.26	Method <code>tangential</code>	106
12.3.27	Method <code>symmedial</code>	107
12.3.28	Method <code>anti</code>	108
12.3.29	Methods <code>euler_line</code> and <code>orthic_axis</code>	108
12.3.30	Euler ellipse	110
12.3.31	Steiner inellipse and circumellipse	111
12.3.32	Harmonic division and bisector	112
12.3.33	Method <code>c_ll_p</code>	113

12.3.34	Method <code>steiner_line</code>	114
12.3.35	Method <code>simson_line</code>	115
12.3.36	Method <code>lemoine_axis</code>	116
12.3.37	Method <code>brocard_axis</code>	117
12.3.38	Method <code>fermat_axis</code>	117
12.3.39	Method <code>taylor_circle</code>	117
12.3.40	Method <code>isogonal</code>	118
13	Class <code>conic</code>	120
13.1	Preamble	120
13.2	Attributes of a conic	121
13.2.1	About attributes of conic	121
13.2.2	Attributes of parabola	122
13.2.3	Attributes of hyperbola	123
13.2.4	Attributs of ellipse	124
13.3	Point-by-point conic construction	125
13.4	Parabola construction	125
13.5	Hyperbola construction	126
13.6	Ellipse construction	127
13.7	Methods of the class <code>conic</code>	127
13.7.1	Method <code>points</code>	128
13.7.2	Method <code>points</code> with parabola	128
13.7.3	Example <code>points</code> with parabola	129
13.7.4	Method <code>points</code> with hyperbola	129
13.7.5	Method <code>points</code> with ellipse	130
13.7.6	Method <code>tangent_at</code>	131
13.7.7	Method <code>tangent_from</code>	131
13.7.8	Parabola with focus, axis of symmetry and curve point	133
13.7.9	Ellipse with center, vertex and covertex	133
13.7.10	Ellipse with foci and point	134
13.7.11	Method <code>point</code>	135
13.7.12	Method <code>in_out</code>	137
13.7.13	Method <code>orthoptic</code>	137
13.8	Intersection line - conic	138
13.9	Useful tools	139
13.9.1	<code>PA_dir</code>	139
13.9.2	<code>PA_focus</code>	140
13.9.3	<code>HY_bifocal</code>	140
13.9.4	<code>EL_bifocal</code>	141
13.9.5	<code>EL_points</code>	141
14	Orthormal cartesian coordinate system	143
14.1	Attributes of an <code>occs</code>	144
14.1.1	Example: attributes of <code>occs</code>	145
14.2	Methods of the class <code>occs</code>	146
15	Class <code>quadrilateral</code>	148
15.1	Quadrilateral Attributes	148
15.1.1	Quadrilateral attributes	148
15.2	Quadrilateral methods	148
15.2.1	Inscribed quadrilateral	149
16	Class <code>square</code>	150
16.1	Square attributes	150
16.1.1	Example: square attributes	150

16.2	Square methods	151
16.2.1	Square with side method	151
17	Class rectangle	152
17.1	Rectangle attributes	152
17.1.1	Example	152
17.2	Rectangle methods	153
17.2.1	Angle method	153
17.2.2	Side method	153
17.2.3	Diagonal method	154
17.2.4	Gold method	154
18	Class parallelogram	155
18.1	Parallelogram attributes	155
18.1.1	Example: attributes	155
18.2	Parallelogram methods	156
18.2.1	Parallelogram with fourth method	156
19	Class regular polygon	157
19.1	Regular_polygon attributes	157
19.1.1	Pentagon	157
19.2	Regular_polygon methods	157
20	Class vector	158
20.1	Attributes of a vector	158
20.1.1	Example vector attributes	159
20.2	Methods of the class vector	159
20.2.1	Example of methods	160
21	Class matrix	161
21.1	Matrix creation	161
21.2	Display a matrix: method print	161
21.3	Attributes of a matrix	161
21.3.1	Attribute set	162
21.3.2	Determinant with real numbers	162
21.3.3	Determinant with complex numbers	162
21.4	Metamethods for the matrices	162
21.4.1	Addition and subtraction of matrices	163
21.4.2	Multiplication and power of matrices	163
21.4.3	Metamethod eq	163
21.5	Methods of the class matrix	163
21.5.1	Function new	164
21.5.2	Function vector	164
21.5.3	Method homogenization	164
21.5.4	Function htm: homogeneous transformation matrix	165
21.5.5	Method get_htm_point	165
21.5.6	Method htm_apply	165
21.5.7	Function square	166
21.5.8	Method print	166
21.5.9	Display a table or array: function print_array	167
21.5.10	Get an element of a matrix: method get	167
21.5.11	Inverse matrix: : method inverse	167
21.5.12	Inverse matrix with power syntax	168
21.5.13	Transpose matrix: method transpose	168
21.5.14	Method method adjugate	168
21.5.15	Method method identity	168

21.5.16	Diagonalization: method <code>diagonalize</code>	169
21.5.17	Method <code>is_orthogonal</code>	169
21.5.18	Method <code>is_diagonal</code>	169
22	Math constants and functions	170
22.1	Length of a segment	170
22.2	Midpoint and midpoints	170
22.3	Bisector	170
22.4	Barycenter	170
22.5	Harmonic division with <code>tkzphi</code>	170
22.6	Function <code>islinear</code> or <code>is_linear</code>	171
22.7	Function value	171
22.8	Function real	171
22.9	Transfer from lua to \TeX	171
22.10	Normalized angles : Slope of lines (ab), (ac) and (ad)	172
22.11	Get angle	173
22.12	Dot or scalar product	174
22.13	Alignment or orthogonality	174
22.14	Bisector and altitude	174
22.15	Other functions	175
22.15.1	Function <code>solve_quadratic</code>	175
23	Intersections	176
23.1	Line-line	176
23.2	Line-circle	177
23.3	Circle-circle	178
23.4	Line-conic	179
23.4.1	Intersection all subtypes of conics	179
23.4.2	Intersection line-parabola, explained	180
24	In-depth study	183
24.1	The tables	183
24.1.1	General tables	183
24.1.2	Table <code>z</code>	184
24.2	Transfers	184
24.3	Complex numbers library and point	185
24.3.1	Example of complex use	185
24.3.2	Point operations (complex)	186
24.4	Barycenter	187
24.4.1	Using the barycentre	187
24.4.2	Incenter of a triangle	187
24.5	Loop and table notation	187
24.6	Use of tables	188
24.6.1	Classic parabola	188
24.6.2	Plotting a curve	189
24.7	<code>In_out</code> method	190
24.7.1	<code>In_out</code> for a line	190
24.8	Determinant and dot product	191
24.8.1	Determinant	191
24.8.2	Dot product	191
24.8.3	Dot product: orthogonality test	191
24.8.4	Dot product: projection	192
24.9	Point method	192
24.10	Behind the objects	193

25	Some theorems	194
25.1	Viviani's Theorem	194
25.2	Reuschle's theorem	194
25.3	Thébault's problem III	195
25.4	Thebault's problem II	196
25.5	Varignon's Theorem	197
25.6	Wittenbauer's Parallelogram	197
25.7	Soddy circles of a triangle	198
25.7.1	Soddy circle without function	198
25.7.2	Soddy circle with function	200
25.8	Six circles in a triangle	201
26	Examples	203
26.1	Length transfer	203
26.2	Apollonius circles of a triangle	203
26.3	D'Alembert 1	204
26.4	D'Alembert 2	205
26.5	Altshiller	205
26.6	Lemoine	206
26.7	Alternate	206
26.8	Method common tangent: orthogonality	207
26.9	Apollonius circle	207
26.10	Apollonius and circle circumscribed	208
26.11	Apollonius circles in a triangle	209
26.12	Archimedes	211
26.13	Bankoff circle	211
26.14	Symmedian property	213
26.15	Example: Cevian with orthocenter	214
26.16	Excircles	214
26.17	Divine ratio	215
26.18	Director circle	216
26.19	Gold division	218
26.20	Ellipse	218
26.21	Ellipse with radii	218
26.22	Ellipse_with_foci	219
26.22.1	Kiepert hyperbola	219
26.22.2	Kierpert parabola	220
26.23	Euler relation	222
26.24	External angle	224
26.25	Internal angle	224
26.26	Feuerbach theorem	225
26.27	Gold ratio with segment	226
26.28	Gold Arbelos	227
26.29	Harmonic division v1	227
26.30	Harmonic division v2	228
26.31	Menelaus	228
26.32	Euler ellipse	229
26.33	Gold Arbelos properties	230
26.34	Apollonius circle v1 with inversion	231
26.35	Apollonius circle v2	232
26.36	Orthogonal circles	234
26.37	Orthogonal circle to two circles	235
26.38	Midcircles	235
26.39	Pencil v1	237
26.40	Pencil v2	238
26.41	Reim v1	239

26.42	Reim v2	239
26.43	Reim v3	240
26.44	Tangent and circle	241
26.45	Homothety	241
26.46	Tangent and chord	242
26.47	Three chords	243
26.48	Three tangents	244
26.49	Midarc	244
26.50	Lemoine axis without macro	245
26.51	First Lemoine circle	245
26.52	First and second Lemoine circles	246
26.53	Inversion	247
26.54	Antiparallel through Lemoine point	248
26.55	Pappus chain	248
26.56	Three Circles	249
26.57	Pentagons in a golden arbelos	250
27	Cheat_sheet	258

1 News

The documentation you are reading corresponds to the latest version (3.32c) of `tkz-elements`. One significant feature introduced in version 3.0 was the use of the `\directlua` macro, replacing the `tkzelements` environment. If you're creating documents with a large number of figures, it's a good idea to place the `init_elements` function at the start of the lua code, to empty the tables. (see examples in this document)

In version 3.10c, most functions have been optimized and a few methods are emerging. In particular, methods for determining a circle tangent to different objects. (see 10.2.30; 10.2.31; 11.2.24; 11.2.25; 11.2.26; and 12.3.33)

In version 3.30c, the main new feature is the introduction of the `conic` class, which allows you to define parabolas, hyperbolas, and ellipses. The previous `ellipse` class is still available but is now obsolete. This new definition is based on a focus, a directrix, and an eccentricity. Curve points are no longer entirely generated using TikZ; instead, they are computed through a geometric construction, stored in a table, and then passed to TikZ to draw the curve. This class also includes various methods, such as tangent computation and intersection with a line.

Use the `tkzDrawCoordinates` macro to draw the curve and the `tkzDrawPointOnCurve` macro to place a point on it.

Other important additions in this version include parallel projection onto a line and the affinity transformation. A small change has also been made to the `regular_polygon` class: the `table` attribute has been replaced with the more explicit `vertices` attribute.

Another change is the removal of scaling in the lua part. It turned out that this caused significant code management issues, while scaling with TikZ was already highly effective (since the most important calculations were already performed). From now on, scaling is not supported by certain functions, so it is recommended to use it only within the `tikzpicture` environment.

In version 3.32c, a change has been made to the `occs` class: the first argument is still a straight line, but it is no longer the directrix of a conic. Instead, it becomes the main axis passing through a vertex and a focus. This axis will serve as the future ordinate axis. This class can, of course, be used for other constructions beyond conics.

2 Structure

After loading the package, the scale is initialized to 1, and then all values in various tables are cleared.

The package defines two macros `\tkzGetNodes` and `\tkzUseLua`.

Additionally, the package loads the file `tkz_elements_main.lua`. This file initializes all the tables that will be used by the modules in which the classes are defined. In this file, a function is defined to reset all tables and the scale. This is the function `init_elements`.

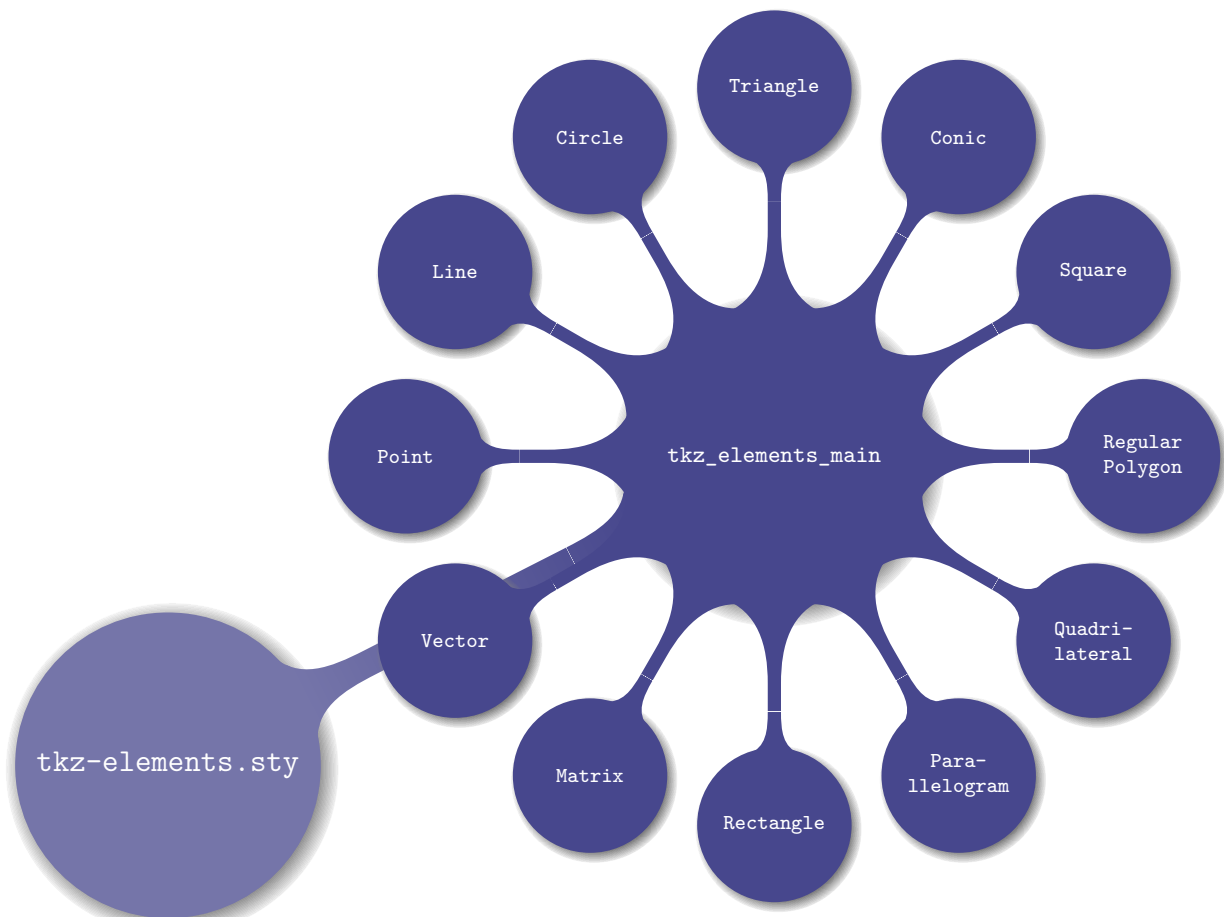

The current classes are :

point (z) ; line (L) ; circle (C) ; triangle (T) ; conic (E) ; quadrilateral (Q) ; square (S) ; rectangle (R) ;
parallelogram (P) ; regular_polygon (RP) ; vector (V) and matrix (M).

If name is name of a class, you can find its definition in the file `tkz_elements_name.lua`.

3 Why tkz-elements?

3.1 Calculation accuracy

3.1.1 Calculation accuracy in TikZ

With TikZ, the expression `veclen(x,y)` calculates the expression $\sqrt{x^2 + y^2}$. This calculation is achieved through a polynomial approximation, drawing inspiration from the ideas of Rouben Rostamian.

```
pgfmathparse{veclen(65,72)} \pgfmathresult
```

$$\sqrt{65^2 + 72^2} \approx 96.9884$$

3.1.2 Calculation accuracy in Lua

A `luaveclen` macro can be defined as follows:

```
\def\luaveclen#1#2{\directlua{tex.print(string.format(
'\percentchar.5f',math.sqrt((#1)*(#1)+(#2)*(#2))))}}
```

and

```
\luaveclen{65}{72}
```

gives

$$\sqrt{65^2 + 72^2} = 97 !!$$

The error, though insignificant when it comes to the placement of an object on a page by a hundredth of a point, becomes problematic for the results of mathematical demonstrations. Moreover, these inaccuracies can accumulate and lead to erroneous constructions.

To address this lack of precision, I initially introduced the `fp`, followed by the package `xfp`. More recently, with the emergence of Lua \TeX , I incorporated a **Lua** option aimed at performing calculations with **Lua**.

This was the primary motivation behind creating the package, with the secondary goal being the introduction of object-oriented programming (OOP) and simplifying programming with Lua. The concept of OOP persuaded me to explore its various possibilities further.

At that time, I had received some Lua programming examples from Nicolas Kisselhoff, but I struggled to understand the code initially, so I dedicated time to studying Lua patiently. Eventually, I was able to develop **tkz-elements**, incorporating many of his ideas that I adapted for the package.

3.1.3 Using objects

Subsequently, I came across an article by Roberto Giacomelli¹ on object-oriented programming using **Lua** and TikZ tools. This served as my second source of inspiration. Not only did this approach enable programming to be executed step-by-step, but the introduction of objects facilitated a direct link between the code and geometry. As a result, the code became more readable, explicit, and better structured.

3.1.4 Example: Apollonius circle

Problem: The objective is to identify an inner tangent circle to the three exinscribed circles of a triangle.

For additional details, refer to [MathWorld](#) for more details.

¹ [Grafica ad oggetti con Lua \$\TeX\$](#)

This example served as my reference for testing the `tkz-euclide` package. Initially, with my first methods and the tools available to me, the results lacked precision. However, with `tkz-elements`, I now have access to more powerful and precise tools that are also easier to use.

The fundamental principles of figure construction with `tkz-euclide` remain intact: definitions, calculations, tracings, labels, as well as the step-by-step programming, mirroring the process of construction with a ruler and compass.

This version utilizes the simplest construction method made possible by Lua.

```
\directlua{
  z.A      = point: new (0,0)
  z.B      = point: new (6,0)
  z.C      = point: new (0.8,4)
  T.ABC    = triangle : new ( z.A,z.B,z.C )
  z.N      = T.ABC.eulercenter
  z.S      = T.ABC.spiekercenter
  T.feuerbach = T.ABC : feuerbach ()
  z.Ea,z.Eb,z.Ec = get_points ( T.feuerbach )
  T.excentral = T.ABC : excentral ()
  z.Ja,z.Jb,z.Jc = get_points ( T.excentral )
  C.JaEa    = circle: new (z.Ja,z.Ea)
  C.ortho   = circle: radius (z.S,math.sqrt(C.JaEa: power(z.S)))
  z.a       = C.ortho.through
  C.euler   = T.ABC: euler_circle ()
  C.apo     = C.ortho : inversion (C.euler)
  z.O       = C.apo.center
  z.xa,z.xb,z.xc = C.ortho : inversion (z.Ea,z.Eb,z.Ec)
}
```

The creation of an object encapsulates its attributes (its characteristics) and methods (i.e. the actions that are specific to it). Subsequently, it is assigned a reference (a name) which is linked to the object using a table. This table functions as an associative array that links the reference, called a key, to a value, in this case, the object. Further elaboration on these notions will be provided later.

For instance, let `T` be a table associating the object `triangle` with the key `ABC`. `T.ABC` is also a table, and its elements are accessed using keys that correspond to attributes of the triangle. These attributes have been defined within the package.

```
z.N = T.ABC.eulercenter
```

`N` is the name of the point, `eulercenter` is an attribute of the triangle.²

```
T.excentral = T.ABC : excentral ()
```

In this context, `excentral` is a method associated with the `T.ABC` object. It defines the triangle formed by the centers of the exinscribed circles.

Of particular importance are two lines of code. The first one below demonstrates that the exceptional precision provided by Lua allows for the definition of a radius through a complex calculation. The radius of the radical circle is determined by $\sqrt{\Pi(S, C(Ja, Ea))}$ (square root of the power of point `S` with respect to the exinscribed circle with center `Ja` passing through `Ea`).

```
C.ortho = circle: radius (z.S,math.sqrt(C.JaEa: power(z.S)))
```

² The center of the Euler circle, or center of the nine-point circle, is a characteristic of every triangle.

Lastly, it's worth noting that the inversion of the Euler circle with respect to the radical circle yields the Apollonius circle³. This transformation requires an object as a parameter, which is recognized by its type (all objects are typed in the package), and the method determines which algorithm to use according to this type.

```
C.apo = C.ortho : inversion (C.euler)
```

Now that all the points have been defined, it's time to start drawing the paths. To accomplish this, nodes need to be created. This is the role of the macro `.Refer` to 7.1.1

The subsequent section exclusively deals with drawings, and is managed by `tkz-euclide`.

```
\begin{tikzpicture}
  \tkzGetNodes
  \tkzFillCircles[green!30](O,xa)
  \tkzFillCircles[teal!30](Ja,Ea Jb,Eb Jc,Ec)
  \tkzFillCircles[lightgray](S,a)
  \tkzFillCircles[green!30](N,Ea)
  \tkzDrawPoints(xa,xb,xc)
  \tkzDrawCircles(Ja,Ea Jb,Eb Jc,Ec S,a O,xa N,Ea)
  \tkzClipCircle(O,xa)
  \tkzDrawLines[add=3 and 3](A,B A,C B,C)
  \tkzDrawPoints(O,A,B,C,S,Ea,Eb,Ec,N)
  \tkzDrawSegments[dashed](S,xa S,xb S,xc)
  \tkzLabelPoints(O,N,A,B)
  \tkzLabelPoints[right](S,C)
\end{tikzpicture}
```

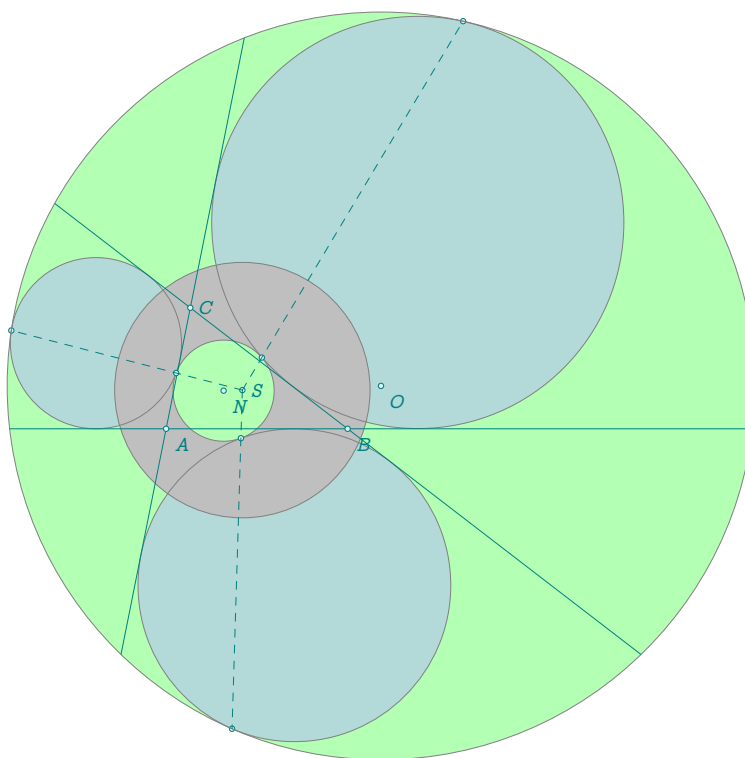



³ The nine-point circle, or Euler circle, is externally tangent to the three circles. The points of tangency form Feuerbach's triangle.

4 Presentation

4.1 With Lua

The primary function of tkz-elements is to calculate dimensions and define points, which is achieved using Lua. You can view tkz-elements as a kernel that is utilized either by tkz-euclide or by TikZ. The lua code can be implemented immediately using the `\directlua` primitive, or it can take place within a `tkzelements` environment which is based on `luacode`. In the latter case, you need to load the `luacode` package. In the first case, if you create a complex document, you'll be able to reset the tables and scale with the `init_elements` function.

The key points are:

- The source file must be  [UTF8](#) encoded.
- Compilation is done with  [LuaTeX](#).
- You need to load TikZ or tkz-euclide and tkz-elements.
- Definitions and calculations are performed in an (orthonormal) Cartesian coordinate system, using Lua with the macro `\directlua` or within the `tkzelements` environment.

On the right, you can see the minimum template.

The code is divided into two parts, represented by lua code, argument to the primitive `\directlua` and the environment `tikzpicture`. In the first part, you place your Lua code, while in the second, you use tkz-euclide commands. The `mini` option for `tkz-euclide` is used to load only the macros required for drawing. In the lua code, it is preferable to systematically use the `init_elements ()` function, which cleans up the tables and re-sets scale to 1. Reminder: from now on, no scaling should be performed in the lua part.

```
% !TEX TS-program = lualatex
% Created by Alain Matthes
\documentclass{standalone}
\usepackage[mini]{tkz-euclide}
% or simply TikZ
\usepackage{tkz-elements}
begin{document}

\directlua{
init_elements ()
% definition of some points
z.A = point : new ( , )
z.B = point : new ( , )

...code...
}

\begin{tikzpicture}
% point transfer to Nodes
\tkzGetNodes

\end{tikzpicture}
\end{document}
```

4.2 The main process

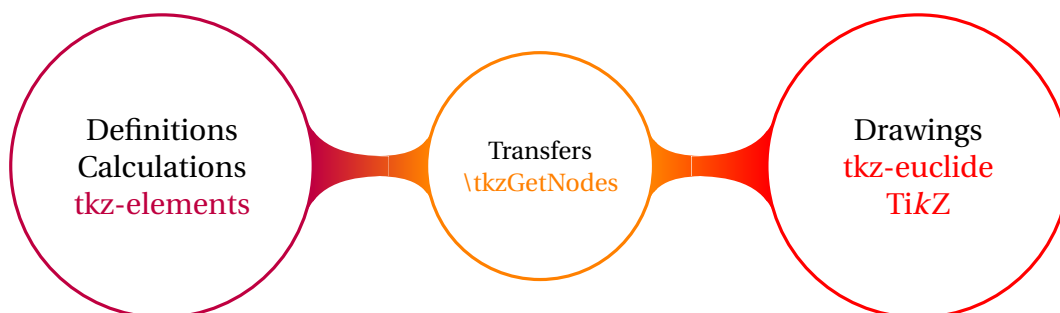

After obtaining all the necessary points for the drawing, they must be transformed into `nodes` so that TikZ or

`tkz-euclide` can render the figure. This is accomplished using the macro `\tkzGetNodes`. This macro iterates through all the elements of the table `z` using the key (which is essentially the name of the point) and retrieves the associated values, namely the coordinates of the point (node).

4.3 Complete example: Pappus circle

4.3.1 The figure

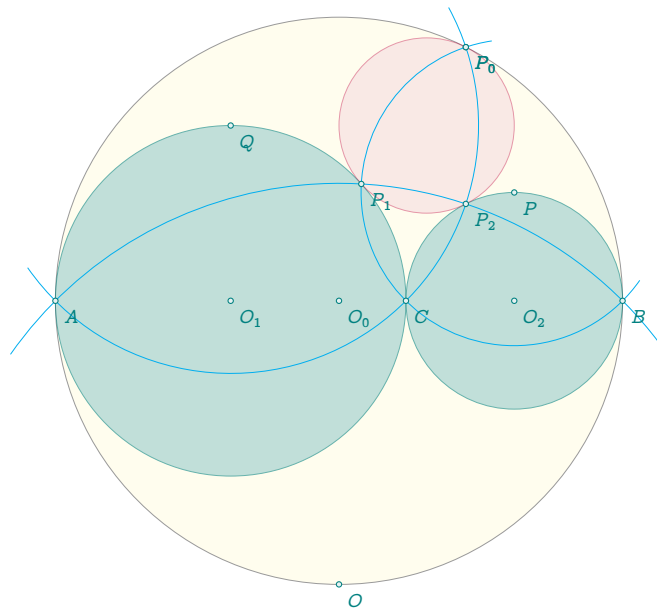

4.3.2 The code

```

% !TEX TS-program = lualatex
\documentclass{article}
\usepackage{tkz-euclide}
\usepackage{tkz-elements}
\begin{document}

\directlua{
init_elements ()
z.A      = point: new (0 , 0)
z.B      = point: new (10 , 0)      % creation of two fixed points $A$ and $B$
L.AB     = line:  new ( z.A, z.B)
z.C      = L.AB:  gold_ratio ()     % use of a method linked to "line"
z.O_0    = line:  new ( z.A, z.B).mid % midpoint of segment with an attribute of "line"
z.O_1    = line:  new ( z.A, z.C).mid % objects are not stored and cannot be reused.
z.O_2    = line:  new ( z.C, z.B).mid
C.AB     = circle: new ( z.O_0, z.B) % new object "circle" stored and reused
C.AC     = circle: new ( z.O_1, z.C)
C.CB     = circle: new ( z.O_2, z.B)
z.P      = C.CB.north               % "north" attributes of a circle
z.Q      = C.AC.north
z.O      = C.AB.south
z.c      = z.C : north (2)          % "north" method of a point (needs a parameter)
C.PC     = circle: new ( z.P, z.C)
C.QA     = circle: new ( z.Q, z.A)
z.P_0    = intersection (C.PC,C.AB) % search for intersections of two circles.
z.P_1    = intersection (C.PC,C.AC) % idem
_,z.P_2  = intersection (C.QA,C.CB) % idem
z.O_3    = triangle: new ( z.P_0, z.P_1, z.P_2).circumcenter
          % circumcenter attribute of "triangle"
}

```

```

\begin{tikzpicture}
  \tkzGetNodes
  \tkzDrawCircle[black,fill=yellow!20,opacity=.4](O_0,B)
  \tkzDrawCircles[teal,fill=teal!40,opacity=.6](O_1,C O_2,B)
  \tkzDrawCircle[purple,fill=purple!20,opacity=.4](O_3,P_0)
  \tkzDrawArc[cyan,delta=10](Q,A)(P_0)
  \tkzDrawArc[cyan,delta=10](P,P_0)(B)
  \tkzDrawArc[cyan,delta=10](O,B)(A)
  \tkzDrawPoints(A,B,C,O_0,O_1,O_2,P,Q,P_0,P_0,P_1,P_2,O)
  \tkzLabelPoints(A,B,C,O_0,O_1,O_2,P,Q,P_0,P_0,P_1,P_2,O)
\end{tikzpicture}
\end{document}

```

4.4 Another example with comments: South Pole

Here's another example with comments

```

% !TEX TS-program = lualatex
\documentclass{standalone}
\usepackage[mini]{tkz-euclide}
\usepackage{tkz-elements}
\begin{document}
\directlua{
  init_elements ()
  z.A      = point: new (2 , 4)
  z.B      = point: new (0 , 0)           % three fixed points are used
  z.C      = point: new (8 , 0)
  T.ABC    = triangle: new (z.A,z.B,z.C) % we create a new triangle object
  C.ins    = T.ABC: in_circle ()         % we get the incircle of this triangle
  z.I      = C.ins.center                % center is an attribute of the circle
  z.T      = C.ins.through                % through is also an attribute
% z.I,z.T = get_points (C.ins)           % get_points is a shortcut
  C.cir    = T.ABC : circum_circle ()   % we get the circumscribed circle
  z.W      = C.cir.center                 % we get the center of this circle
  z.O      = C.cir.south                  % now we get the south pole of this circle
  L.AO     = line: new (z.A,z.O)         % we create an object "line"
  L.BC     = T.ABC.bc                     % we get the line (BC)
  z.I_A    = intersection (L.AO,L.BC)    % we search the intersection of the last lines
}

```

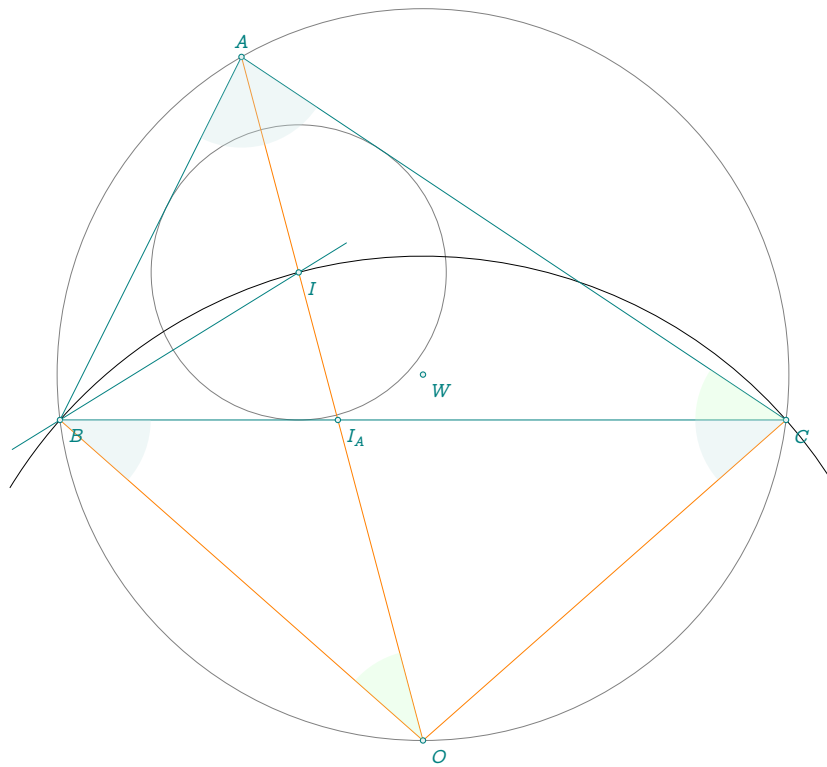

Here's the tikzpicture environment to obtain the drawing:

```

\begin{tikzpicture}
\tkzGetNodes
\tkzDrawCircles(W,A I,T)
\tkzDrawArc(O,C)(B)
\tkzDrawPolygon(A,B,C)
\tkzDrawSegments[new](A,O B,O C,O)
\tkzDrawLine(B,I)
\tkzDrawPoints(A,B,C,I,I_A,W,O)
\tkzFillAngles[green!20,opacity=.3](A,O,B A,C,B)
\tkzFillAngles[teal!20,opacity=.3](O,B,C B,C,O B,A,O O,A,C)
\tkzLabelPoints(I,I_A,W,B,C,O)
\tkzLabelPoints[above](A)
\end{tikzpicture}

```

5 Writing Convention

5.1 Miscellaneous

- As with `tkz-euclide`, the chosen unit is the centimeter, and by default, points are located in an orthonormal Cartesian coordinate system.
- Numerical variable: the writing conventions for real numbers are the same as for Lua.
- Complex numbers: Similar to real numbers, but to define them, you must write `za = point (1,2)`. Mathematically, this corresponds to $1+2i$, which you can find with `tex.print(tostring(za))`. (Refer 24.3)
- Boolean: you can write `bool = true` or `bool = false` then with Lua you can use the code :

```
if bool == ... then ... else ... end
```

and you can use the macro

```
\ifthenelse{\equal{\tkzUseLua{bool}}{true}}{ ... }{ ... }
```

after loading the `ifthen` package.

- String: if `st = "Euler's formula"` then

```
\tkzUseLua{st} gives Euler's formula
```

5.2 Assigning a Name to a Point

At present, the only obligation is to store the points in the table `z`⁴ if you intend to use them in TikZ or `tkz-euclide`. If a point will not be used, you can designate it as you wish while adhering to Lua conventions. Points in the lua code must follow a convention in the form `z.name`, where `name` represents the name of the corresponding **node**.

As for the conventions for designating name you must adhere to Lua conventions in particular cases.

1. The use of prime can be problematic. If the point name contains more than one symbol and ends with `p` then when passing into `tkz-euclide`, the letters `p` will be replaced by `'` using the macro `\tkzGetNodes`;
2. Alternatively, for a more explicit code, suppose you want to designate a point as "euler". You could, for example, write `euler = ...`, and at the end of the code for the transfer, `z.E = euler`. It is also possible to use a temporary name `euler` and to replace it in TikZ. Either at the time of placing the labels, or for example by using `pgfnodealias{E}{euler}`. This possibility also applies in other cases: prime, double prime, etc.

Here are some different ways of naming a point:

- `z.A = point : new (1,2)`
- `z.Bp = point : new (3,4) -> this gives B' in the tikzpicture`
- `z.H_a = T.ABC : altitude () -> this gives H_a in the tikzpicture code and H_a in the display.`

⁴ To place the point `M` in the table, simply write `z.M = ...` or `z["M"] = ...`

5.3 Assigning a Name to Other Objects

You have the flexibility to assign names to objects other than points. However, it's advisable to adhere to certain conventions to enhance code readability. For my examples, I've chosen the following conventions: first of all, I store the objects in tables: L for lines and segments, C for circles, T for triangles, EL for ellipses, PA for parabolas and HY for hyperbolas.

- For lines, I use the names of the two points they pass through. For example, if a line passes through points A and B , I name the line $L.AB$.
- Circles are stored in table named C . For example, I name $C.AB$ the circle of center A passing through B . Other names like $C.euler$ or $C.external$ are also acceptable.
- Triangles are stored in table named T . For example, I name $T.ABC$ the triangle whose vertices are A , B and C . However, names like $T.feuerbach$ are also acceptable.
- Parabolas are stored in table named PA , it's HY for hyperbolas and EL for ellipses. For ellipses, I name $E.ABC$ the ellipse with center A through vertex B and covertex C .

Adhering to these conventions can help improve the readability of the code.

5.4 Writing conventions for attributes, methods.

You must use the conventions of Lua, so

- To obtain an attribute, for all objects, the convention is identical: `object.attribute`. For example, for the point A we access its abscissa with `z.A.re` and its ordinate with `z.A.im`; as for its type we obtain it with `z.A.type`. To get the south pole of the circle $C.OA$ you need to write: `C.OA.south`.
- To use a method such as obtaining the incircle of a triangle ABC , just write `C.incircle = T.ABC : in_circle ()`.
- Some methods need a parameter. For example, to know the distance between a point C to the line (A, B) we will write `d = L.AB : distance (z.C)`.
- Use the underscore to store a result you don't want to use. If you only need the second point of an intersection between a line and a circle, you would write `_,z.J = intersection (L.AB , C.OC)`.

6 Work organization

Here's a sample organization.

The line `% !TEX TS-program = lualatex` ensures that you compile with Lua \LaTeX . The standalone class is useful, as all you need to do here is create a figure.

You can load `tkz-euclide` in three different ways. The simplest is `\usepackage [mini] {tkz-euclide}` and you have full access to the package. You also have the option to use the `lua` option. This will allow you, if you want to perform calculations outside of `tkz-elements`, to obtain them using `lua`. Finally, the recommended method is to use the `mini` option. This allows you to load only the modules necessary for drawing. You can still optionally draw using `TikZ`.

The package `ifthen` is useful if you need to use some Boolean.

While it's possible to leave the Lua code in the macro `directlua`, externalizing this code has its advantages.

The first advantage is that, if you use a good editor, you have a better presentation of the code. Styles differ between Lua and \LaTeX , making the code clearer. This is how I proceeded, then reintegrated the code into the main code.

Another advantage is that you don't have to incorrectly comment the code. For Lua code, you comment lines with `--` (double minus sign), whereas for \LaTeX , you comment with `%`.

A third advantage is that the code can be reused.

```

% !TEX TS-program = lualatex
% Created by Alain Matthes on 2024-01-09.
\documentclass[margin = 12pt]{standalone}
\usepackage[mini]{tkz-euclide}
\usepackage{tkz-elements,ifthen}

\begin{document}
\directlua{
  init_elements ()
  dofile ("sangaku.lua")
}
\begin{tikzpicture}[scale = 1.25]
  \tkzGetNodes
  \tkzDrawCircle(I,F)
  \tkzFillPolygon[color = purple](A,C,D)%
  \tkzFillPolygon[color = blue!50!black](A,B,C)%
  \tkzFillCircle[color = orange](I,F)%
\end{tikzpicture}
\end{document}

```

And here is the code for the Lua part: the file `ex_sangaku.lua`

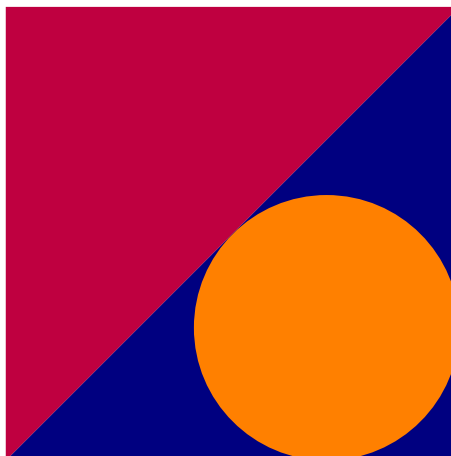

```

z.A      = point : new ( 0,0 )
z.B      = point : new ( 8,0 )
L.AB     = line  : new ( z.A , z.B )
S        = L.AB : square ()
_,_,z.C,z.D = get_points (S)
z.F      = S.ac : projection (z.B)
L.BF     = line  : new (z.B,z.F)
T.ABC    = triangle : new ( z.A , z.B , z.C )
L.bi     = T.ABC : bisector (2)
z.c      = L.bi.pb
L.Cc     = line  : new (z.C,z.c)
z.I      = intersection (L.Cc,L.BF)

```

6.1 Scale problem

With the next version, I had previously suggested that it was preferable to perform scaling in the Lua part. However, from now on, the opposite will be true. Since all calculations are carried out in Lua, scaling with TikZ is not a problem after all. Moreover, the recent addition of functions for conics has caused several difficulties due to the handling of numerous distances (i.e., real numbers). This led me to review some functions, and I fixed a few bugs related to the use of scaling in the Lua part. From now on, scaling should be reserved for the TikZ part. The following documentation uses only scaling in the `tikzpicture`.

6.2 Code presentation

The key point is that, unlike \LaTeX or \TeX , you can insert spaces absolutely anywhere.

7 Transfers

7.1 From Lua to tkz-euclide or TikZ

In this section, we'll explore how to transfer points, booleans, and numerical values.

7.1.1 Points transfer

The necessary definitions and calculations are performed with the primitive `\directlua` or inside the environment `tkzelements`. Then, we execute the macro which transforms the affixes of the table `z` into `Nodes`. Finally, we proceed with the drawing.

At present, the drawing program is either TikZ or tkz-euclide. However, you have the option to use another package for plotting. To do so, you'll need to create a macro similar to `\tkzGetNodes`. Of course, this package must be capable of storing points like TikZ or tkz-euclide.

```
\def\tkzGetNodes{\directlua{%
  for K,V in pairs(z) do
    local n,sd,ft
    n = string.len(K)
    if n >1 then
      _,_,ft, sd = string.find( K , "(.+)(") )
      if sd == "p" then K=ft.."'" end
      _,_,xft, xsd = string.find( ft , "(.+)(") )
      if xsd == "p" then K=xft.."'".."'" end
    end
    tex.print("\coordinate ("..K..) at ("..V.re..","..V.im..) ;\\")
  end}
}
```

See the section In-depth Study 24 for an explanation of the previous code.

Point names can contain the underscore `_` and the macro `\tkzGetNodes` allows to obtain names of nodes containing `prime` or `double prime`. (Refer to the next example)

```
\directlua{
  init_elements ()
  z.o = point: new (0,0)
  z.a_1 = point: new (2,1)
  z.a_2 = point: new (1,2)
  z.ap = z.a_1 + z.a_2
  z.app = z.a_1 - z.a_2
}
\begin{tikzpicture}[ scale = 1.5]
  \tkzGetNodes
  \tkzDrawSegments(o,a_1 o,a_2 o,a' o,a'')
  \tkzDrawSegments[red] (a_1,a' a_2,a')
  \tkzDrawSegments[blue] (a_1,a'' a_2,a'')
  \tkzDrawPoints(a_1,a_2,a',o,a'')
  \tkzLabelPoints(o,a_1,a_2,a',a'')
\end{tikzpicture}
```

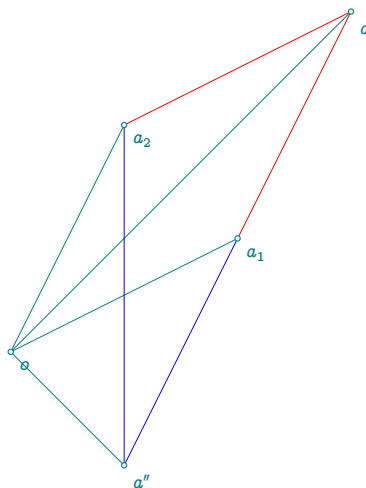

7.1.2 Other transfers

Sometimes it's useful to transfer angle, length measurements or boolean. For this purpose, I have created the macro (refer to 22.9) `tkzUseLua(value)`

```
\def\tkzUseLua#1{\directlua{tex.print(tostring(#1))}}
```

The intersection of the two lines lies at a point whose affix is:

```
\directlua{
  init_elements ()
  z.b = point: new (1,1)
  z.a = point: new (4,2)
  z.c = point: new (2,2)
  z.d = point: new (5,1)
  L.ab = line : new (z.a,z.b)
  L.cd = line : new (z.c,z.d)
  det = (z.b-z.a)^(z.d-z.c)
  if det == 0 then bool = true
    else bool = false
  end
  x = intersection (L.ab,L.cd)
}
```

The intersection of the two lines lies at a point whose affix is:\tkzUseLua{x}

```
\begin{tikzpicture}
  \tkzGetNodes
  \tkzInit[xmin =0,ymin=0,xmax=5,ymax=3]
  \tkzGrid\tkzAxeX\tkzAxeY
  \tkzDrawPoints(a,...,d)
  \ifthenelse{\equal{\tkzUseLua{bool}}{true}}{
    \tkzDrawSegments[red](a,b c,d){%
    \tkzDrawSegments[blue](a,b c,d)}
    \tkzLabelPoints(a,...,d)
  }
\end{tikzpicture}
```

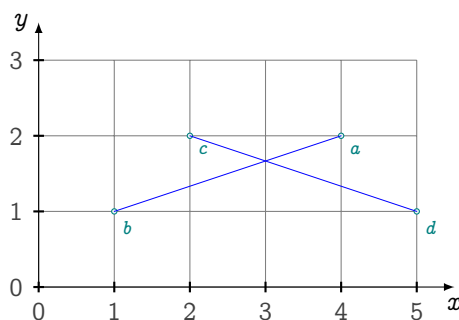

7.1.3 Example 1

In this example, it's necessary to transfer the function to the Lua part, then retrieve the curve point coordinates from $\text{T}_{\text{E}}\text{X}$.

The main tools used are a table and its methods (`insert,concat`) and the load function.

```
\makeatletter\let\percentchar\@percentchar\makeatother
\directlua{
  function list (f,min,max,nb)
    local tbl = {}
    for x = min, max, (max - min) / nb do
      table.insert (tbl, ('\percentchar f,\percentchar f'):format (x, f (x)))
    end
    return table.concat (tbl)
  end
}
\def\plotcoords#1#2#3#4{%
\directlua{%
  f = load ([[
    return function (x)
      return (\percentchar s)
    end
  ]])
}
```

```

]]):format ([[#1]]), nil, 't', math) ()
tex.print(list(f,#2,#3,#4))}
}
\begin{tikzpicture}
\tkzInit[xmin=1,xmax=3,ymin=0,ymax=2]
\tkzGrid
\tkzDrawX[right=3pt,label={x}]
\tkzDrawY[above=3pt,label={f(x) = \frac{1-\mathrm{e}^{-x^2}}{1+\mathrm{e}^{-x^2}}}]
\draw[cyan,thick] plot coordinates {\plotcoords{(1-exp(-x^2))/(exp(-x^2)+1)}{-3}{3}{100}};
\end{tikzpicture}

```

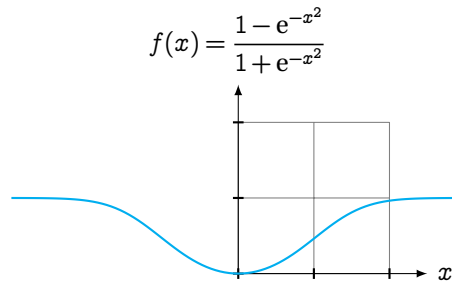

7.1.4 Example 2

This consists in passing a number (the number of sides) from $\text{T}_\text{E}\text{X}$ to Lua. This is made easier by using the `\directlua` primitive. This example is based on a answer from egreg [\[egreg-tex.stackexchange.com\]](https://tex.stackexchange.com)

```

\directlua{
  z.I      = point:    new (0,0)
  z.A      = point:    new (2,0)
}
\def\drawPolygon#1{
\directlua{
  RP.six   = regular_polygon : new (z.I,z.A,#1)
  RP.six : name ("P_")
}
\begin{tikzpicture}[scale=.5]
\def\nb{\tkzUseLua{RP.six.nb}}
\tkzGetNodes
\tkzDrawCircles(I,A)
\tkzDrawPolygon(P_1,P_... ,P_\nb)
\tkzDrawPoints[red](P_1,P_... ,P_\nb)
\end{tikzpicture}
}
\foreach [count=\i] \n in {3, 4, ..., 10} {
\makebox[0.2\textwidth]{%
\begin{tabular}[t]{@{}c@{}}
  \$n=\n\$ \\[1ex]
  \drawPolygon{\n}
\end{tabular}%
}\ifnum\i=4 \\[2ex]\fi
}

```

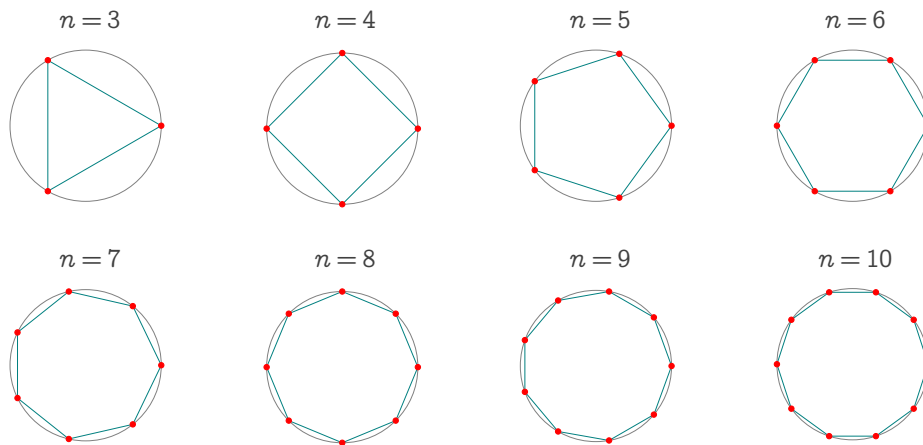

7.1.5 Example 3

This time, the transfer will be carried out using an external file. The following example is based on this one, but using a table.

```
\directlua{
  init_elements()
  z.a = point: new (1,0)
  z.b = point: new (3,2)
  z.c = point: new (0,2)
  A,B,C = parabola (z.a,z.b,z.c)

function f(t0, t1, n)
  local out=assert(io.open("tmp.table","w"))
  local y
  for t = t0,t1,(t1-t0)/n do
    y = A*t^2+B*t +C
    out:write(t, " ", y, " i\\string\\n")
  end
  out:close()
end
}
\begin{tikzpicture}
  \tkzGetNodes
  \tkzInit[xmin=-1,xmax=5,ymin=0,ymax=5]
  \tkzDrawX\tkzDrawY
  \tkzDrawPoints[red,size=2](a,b,c)
  \directlua{f(-1,3,100)}%
  \draw[domain=-1:3] plot[smooth] file {tmp.table};
\end{tikzpicture}
```

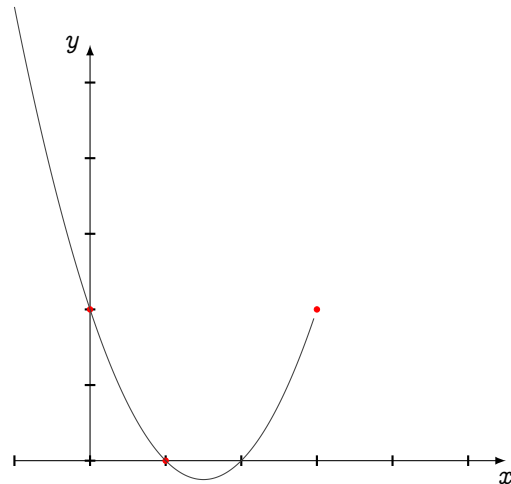

7.1.6 Example 4

The result is identical to the previous one.

```
\directlua{
  z.a = point: new (1,0)
  z.b = point: new (3,2)
  z.c = point: new (0,2)
  A,B,C = parabola (z.a,z.b,z.c)

function f(t0, t1, n)
  local tbl = {}
```

```

for t = t0,t1,(t1-t0)/n do
  y = A*t^2+B*t +C
  table.insert (tbl, "...t..","..y..")
end
return table.concat (tbl)
end
}
\begin{tikzpicture}
  \tkzGetNodes
  \tkzDrawX\tkzDrawY
  \tkzDrawPoints[red,size=2pt](a,b,c)
  \draw[domain=-2:3,smooth] plot coordinates {\directlua{tex.print(f(-2,3,100))}};
\end{tikzpicture}

```

7.1.7 Example 5

```

\makeatletter\let\percentchar\@percentchar\makeatother
\directlua{
function cellx (start,step,n)
return start+step*(n-1)
end
}
\def\calcval#1#2{%
\directlua{
  f = load ([[
    return function (x)
      return (\percentchar s)
    end
  ]]):format ([[#1]], nil, 't', math) ()
x = #2
tex.print(string.format("\percentchar.2f",f(x)))}
}
\def\fvalues(#1,#2,#3,#4) {%
\def\firstline{${x}$}
  \foreach \i in {1,2,...,#4}{%
    \xdef\firstline{\firstline & \tkzUseLua{cellx(#2,#3,\i)}}}
\def\secondline{${f(x)}=#1$}
  \foreach \i in {1,2,...,#4}{%
    \xdef\secondline{\secondline &
      \calcval{#1}{\tkzUseLua{cellx(#2,#3,\i)}}}}
\begin{tabular}{l*{#4}c}
  \toprule
  \firstline \\
  \secondline \\
  \bottomrule
\end{tabular}
}
\fvalues(x^2-3*x+1,-2,.25,8)
\vspace{12pt}

```

x	-2.0	-1.75	-1.5	-1.25	-1.0	-0.75	-0.5	-0.25
$f(x) = x^2 - 3 * x + 1$	11.00	9.31	7.75	6.31	5.00	3.81	2.75	1.81

8 Class and object

8.1 Class

Object-oriented programming (OOP) is a programming model based on the concept of objects. An object can be defined as a data table that has unique attributes and methods (operations) that define its behavior.

A class is essentially a user-defined data type. It describes the contents of the objects that belong to it. A class serves as a blueprint for creating objects, providing initial values for attributes and implementations of methods⁵ that are common to all objects of a certain kind.

8.2 Object

An Object is an instance of a class. Each object contains attributes and methods. Attributes are information or object characteristics of the object stored in the data table (called fields), while methods define the object's behavior.

All objects in the package are typed. The object types currently defined and used are: **point**, **line**, **circle**, **triangle**, **conic**, **quadrilateral**, **square**, **rectangle**, **parallelogram** and **regular_polygon**.

These objects can be created directly using the method `new` by giving points, with the exception of the `classpoint` class which requires a pair of reals, and `classregular_polygon` which needs two points and an integer.

Objects can also be obtained by applying methods to other objects. For example, `T.ABC : circum_circle ()` creates an object **circle**. Some object attributes are also objects themselves, such as `T.ABC.bc` which creates the **line** object, representing a straight line passing through the last two points defining the triangle.

8.2.1 Attributes

Attributes are accessed using the classic method, so `T.pc` retrieves the third point of the triangle and `C.OH.center` retrieves the center of the circle. Additionally, I've added a `get_points` function that returns the points of an object. This function applies to straight lines (`pa` and `pc`), triangles (`pa`, `pb` and `pc`) and circles (`center` and `through`).

Example: `z.O,z.T = get_points (C)` retrieves the center and a point of the circle.

8.2.2 Methods

A method is an operation (function or procedure) associated (linked) with an object.

Example: The point object is used to vertically determine a new point object located at a certain distance from it (here 2). Then it is possible to rotate objects around it.

```
\directlua{
  init_elements ()
  z.A = point (1,0)
  z.B = z.A : north (2)
  z.C = z.A : rotation (math.pi/3,z.B)
  tex.print(tostring(z.C))
}
```

The coordinates of C are: -0.73205080756888 and 1.0

⁵ action which an object is able to perform.

9 Class point

The foundation of the entire framework is the point class. This class is hybrid in the sense that it deals with both points in a plane and complex numbers. The principle is as follows: the plane is equipped with an orthonormal basis, which allows us to determine the position of a point using its abscissa and ordinate coordinate. Similarly, any complex number can be viewed simply as a pair of real numbers (its real part and its imaginary part). We can then designate the plane as the complex plane, and the complex number $x + iy$ is represented by the point of the plane with coordinates (x, y) . Thus the point A will have coordinates stored in the object $z.A$. Coordinates are attributes of the point object, along with type, argument, and modulus.

The creation of a point is done using the following method, but there are other possibilities. If a scaling factor has been given, the method takes it into account.

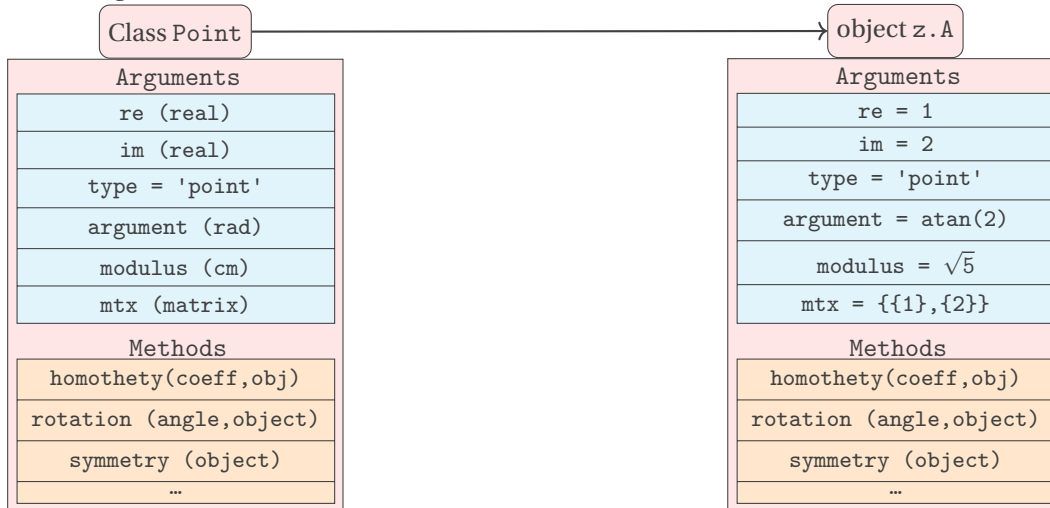

9.1 Attributes of a point

Creation

```
z.A = point: new (1,2)
```

The point A has coordinates $x = 1$ and $y = 2$. If you use the notation $z.A$, then A will be referenced as a node in TikZ or in `tkz-euclide`.

This is the creation of a fixed point with coordinates 1 and 2 and which is named A . The notation $z.A$ indicates that the coordinates will be stored in a table denoted as z (reference to the notation of the affixes of the complex numbers) that A is the name of the point and the key allowing access to the values.

Table 1: Point attributes.

Attributes	Application	Example
re	<code>z.A.re = 1</code>	[8.2.2]
im	<code>z.A.im = 2</code>	[8.2.2]
type	<code>z.A.type = 'point'</code>	
argument	<code>z.A.argument ≈ 0.78539816339745</code>	[9.1.1]
modulus	<code>z.A.modulus $\approx 2.2360\dots = \sqrt{5}$</code>	[9.1.1]
mtx	<code>z.A.mtx = $\{\{1\},\{2\}\}$</code>	[9.1.1]

9.1.1 Example: point attributes

```

\directlua{
  init_elements ()
  z.M = point: new (1,2)}

\begin{tikzpicture}[scale = 1]
\pgfkeys{/pgf/number format/.cd,std,precision=2}
\let\pmpn\pgfmathprintnumber
\tkzDefPoints{2/4/M,2/0/A,0/0/O,0/4/B}
\tkzLabelPoints(O)
\tkzMarkAngle[fill=gray!30,size=1](A,0,M)
\tkzLabelAngle[pos=1,right](A,0,M){%
 $\theta \approx \pmpn{\tkzUseLua{z.M.argument}}$  rad}
\tkzDrawSegments(O,M)
\tkzLabelSegment[above,sloped](O,M){%
 $|z_M| = \sqrt{5} \approx \pmpn{\tkzUseLua{z.M.modulus}}$  cm}
\tkzLabelPoint[right](M){ $M : z_M = 1 + 2i$ }
\tkzDrawPoints(M,A,O,B)
\tkzPointShowCoord(M)
\tkzLabelPoint[below,teal](A){ $\tkzUseLua{z.M.re}$ }
\tkzLabelPoint[left,teal](B){ $\tkzUseLua{z.M.im}$ }
\tkzDrawSegments[->,add = 0 and 0.25](O,B O,A)
\end{tikzpicture}

```

Attributes of $z.M$

- $z.M.re = 1$
- $z.M.im = 2$
- $z.M.type = 'point'$
- $z.M.argument = \theta \approx 1.11 \text{ rad}$
- $z.M.modulus = |z_M| = \sqrt{5} \approx 2.24 \text{ cm}$
- $z.M.mtx = \begin{bmatrix} 1 \\ 2 \end{bmatrix}$

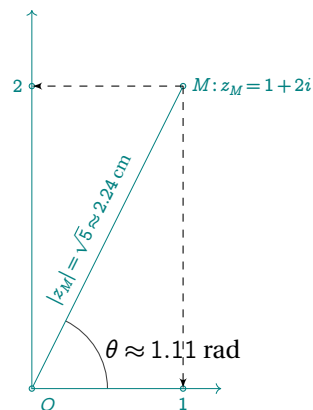
9.1.2 Attribute mtx

This method allows the point to be used in conjunction with matrices.

```

\directlua{
z.A = point : new (2,-1)
z.A.mtx : print ()
}

```

$$\begin{bmatrix} 2 \\ -1 \end{bmatrix}$$

9.1.3 Argand diagram

```

\directlua{
init_elements ()
  z.A = point : new ( 2 , 3 )
  z.O = point : new ( 0 , 0 )
  z.I = point : new ( 1 , 0 )
}
\begin{tikzpicture}
  \tkzGetNodes
  \tkzInit[xmin=-4,ymin=-4,xmax=4,ymax=4]
  \tkzDrawCircle[dashed,red](O,A)
  \tkzPointShowCoord(A)
  \tkzDrawPoint(A)
  \tkzLabelPoint[above right](A){\normalsize  $a+ib$ }
  \tkzDrawX\tkzDrawY
  \tkzDrawSegment(O,A)
  \tkzLabelSegment[above,anchor=south,sloped](O,A){  $OA = \text{modulus of } z_A$  }
  \tkzLabelAngle[anchor=west,pos=.5](I,O,A){  $\theta = \text{argument of } z_A$  }
\end{tikzpicture}

```

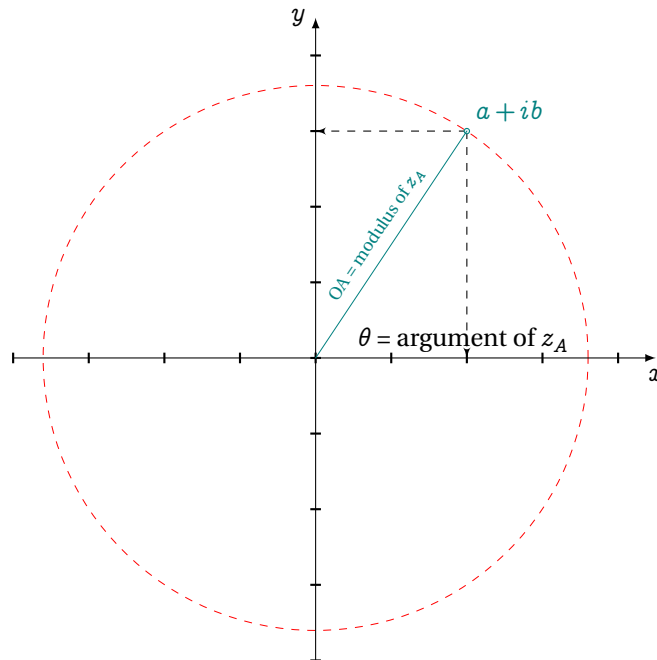

9.2 Methods of the class point

The methods described in the following table are standard and can be found in most of the examples at the end of this documentation. The result of the different methods presented in the following table is a **point**. Refer to section (24.3) for the metamethods.

Table 2: Functions & Methods of the class point.

Functions	Application	
<code>new(r,r)</code>	<code>z.A = point : new(1,2)</code>	[9.2.3]
<code>polar (d,an)</code>	<code>z.A = point : polar(1,math.pi/3)</code>	[26.12]
<code>polar_deg (d,an)</code>	an in deg	polar coordinates an deg
Methods	Application	
Points		
<code>north(r)</code>	r distance to the point (1 if empty)	8.2.2]
<code>south(r)</code>		
<code>east(r)</code>		
<code>west(r)</code>		
<code>normalize()</code>	<code>z.b = z.a: normalize ()</code>	[9.2.3]
<code>get_points (obj)</code>	retrieves points from the object	[9.2.7; 10.2.29]
<code>orthogonal (d)</code>	<code>z.B=z.A:orthogonal(d)</code>	$\overrightarrow{OB} \perp \overrightarrow{OA}$ and $OB = d$. [9.2.4]
<code>at ()</code>	<code>z.X = z.B : at (z.A)</code>	$\overrightarrow{OB} = \overrightarrow{AX}$ and $OB = d$. [9.2.5]
Transformations		
<code>symmetry(obj)</code>	obj : point, line, etc.	[9.2.8]
<code>rotation(an , obj)</code>	point, line, etc.	[9.2.7]
<code>homothety(r,obj)</code>	<code>z.c = z.a : homothety (2,z.b)</code>	[26.45]
Misc.		
<code>print()</code>	displays the affix of the point	[9.2.8]

9.2.1 Method north (d)

This function defines a point located on a vertical line passing through the given point. This function is useful if you want to report a certain distance (Refer to the following example). If d is absent then it is considered equal to 1.

```
\directlua{
  init_elements ()
  z.O = point : new ( 0, 0 )
  z.A = z.O : east ()
  z.Ap = z.O : east (2) : north (2)
  z.B = z.O : north ()
  z.C = z.O : west ()
  z.D = z.O : south ()
}
\begin{tikzpicture}
  \tkzGetNodes
  \tkzDrawPolygon(A,B,C,D)
  \tkzDrawPoints(A,B,C,D,O,A')
\end{tikzpicture}
```

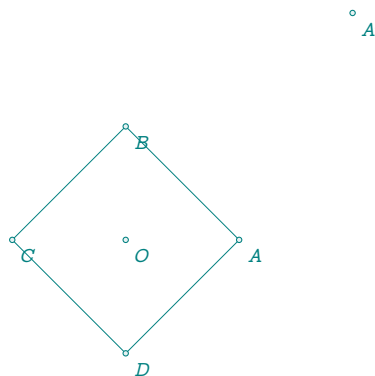

9.2.2 Method polar

This involves defining a point using its modulus and argument.

```

\directlua{
  init_elements ()
  z.O = point : new (0, 0)
  z.A = point : new (3, 0)
  z.F = point : polar (3, math.pi/3)
}
\begin{tikzpicture}
  \tkzGetNodes
  \tkzDrawCircle(O,A)
  \tkzDrawSegments[new](O,A)
  \tkzDrawSegments[purple](O,F)
  \tkzDrawPoints(A,O,F)
  \tkzLabelPoints[below right=6pt](A,O)
  \tkzLabelPoints[above](F)
\end{tikzpicture}

```

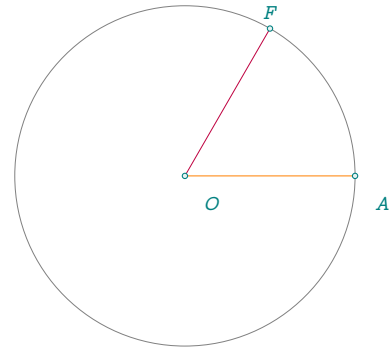

9.2.3 Method `normalize ()`

The result is a point located between the origin and the initial point at a distance of 1 from the origin.

```

\directlua{
  init_elements ()
  z.O = point : new (0,0)
  z.A = point : new (1,2)
  z.B = z.A : normalize ()
  z.I = point : new (1,0)
}
\begin{tikzpicture}[scale = 1.5]
  \tkzGetNodes
  \tkzDrawSegment(O,A)
  \tkzDrawCircle(O,B)
  \tkzDrawPoints(O,A,B,I)
  \tkzLabelPoints(O,A,B)
  \tkzLabelPoint[below right](I){$1$}
\end{tikzpicture}

```

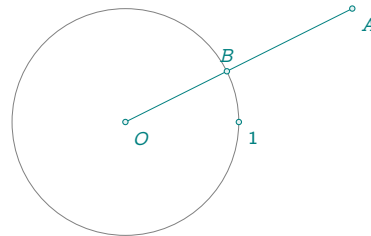

9.2.4 Method `orthogonal (d)`

Let O be the origin of the plane. The `orthogonal (d)` method is used to obtain a point B from a point A such that $\overrightarrow{OB} \perp \overrightarrow{OA}$ with $OB = OA$ if d is empty, otherwise $OB = d$.

```

\directlua{
  init_elements ()
  z.A = point : new ( 3 , 1 )
  z.B = z.A : orthogonal (1)
  z.O = point : new ( 0,0 )
  z.C = z.A : orthogonal ()
}
\begin{tikzpicture}[gridded]
  \tkzGetNodes
  \tkzDrawSegments(O,A O,C)
  \tkzDrawPoints(O,A,B,C)
  \tkzLabelPoints[below right](O,A,B,C)
\end{tikzpicture}

```

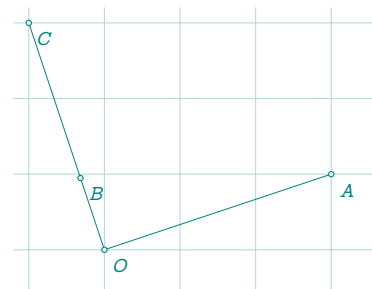

9.2.5 Method `at`

This method is complementary to the previous one, so you may not wish to have $\overrightarrow{OB} \perp \overrightarrow{OA}$ but $\overrightarrow{AB} \perp \overrightarrow{OA}$.

```

\directlua{%
init_elements ()
z.O = point : new ( 0,0 )
z.A = point : new ( 3 , 2 )
z.B = z.A : orthogonal (1)
z.C = z.A+z.B
z.D =(z.C-z.A):orthogonal(2) : at (z.C)
}
\begin{tikzpicture}[gridded]
\tkzGetNodes
\tkzLabelPoints[below right](O,A,C)
\tkzLabelPoints[above](B,D)
\tkzDrawSegments(O,A A,B A,C C,D O,B)
\tkzDrawPoints(O,A,B,C,D)
\end{tikzpicture}

```

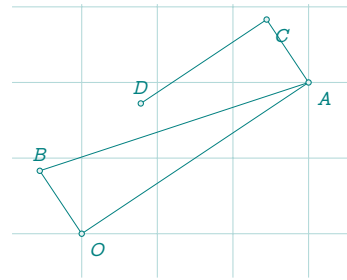

9.2.6 Method rotation first example

The arguments are the angle of rotation in radians, and here a list of points.

```

\directlua{%
init_elements ()
z.a = point: new(0, -1)
z.b = point: new(4, 0)
z.o = point: new(6, -2)
z.ap,z.bp = z.o : rotation (math.pi/2,z.a,z.b)
}
\begin{tikzpicture}
\tkzGetNodes
\tkzDrawLines(o,a o,a' o,b o,b')
\tkzDrawPoints(a,a',b,b',o)
\tkzLabelPoints(b,b',o)
\tkzLabelPoints[below left](a,a')
\tkzDrawArc(o,a)(a')
\tkzDrawArc(o,b)(b')
\end{tikzpicture}

```

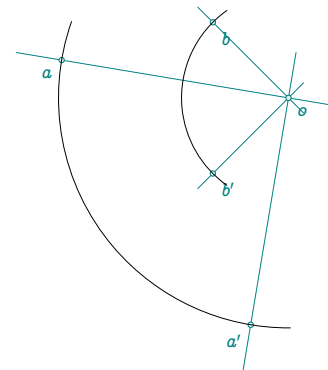

9.2.7 Method rotation second example

Rotate a triangle by an angle of $\pi/6$ around O .

```

\directlua{%
init_elements ()
  z.O = point: new(-1, -1)
  z.A = point: new(2, 0)
  z.B = point: new(5, 0)
  L.AB = line: new(z.A,z.B)
  T.ABC = L.AB: equilateral()
  S.fig = L.AB: square ()
  --,
  z.E,z.F = get_points(S.fig)
  S.new = z.O : rotation(math.pi/3,S.fig)
  _,_,z.Ep,z.Fp = get_points( S.new )
  z.C = T.ABC.pc
  T.ApBpCp = z.O : rotation(math.pi/3,T.ABC)
  z.Ap,z.Bp,z.Cp = get_points ( T.ApBpCp)
}
\begin{tikzpicture}[scale = .75]
  \tkzGetNodes
  \tkzDrawPolygons(A,B,C A',B',C'%
    A,B,E,F A',B',E',F')
  \tkzDrawPoints (A,B,C,A',B',C',O)
  \tkzLabelPoints (A,B,C,A',B',C',O)
  \tkzDrawArc[delta=0,->](O,A)(A')
\end{tikzpicture}

```

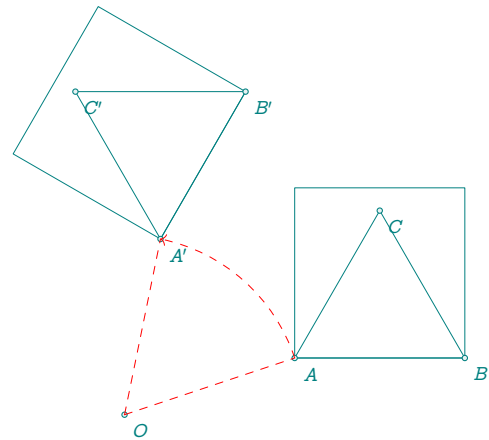

9.2.8 Method symmetry

Example of the symmetry of an object

```

\directlua{%
init_elements ()
  z.a = point: new(0,-1)
  z.b = point: new(2, 0)
  L.ab = line : new (z.a,z.b)
  C.ab = circle : new (z.a,z.b)
  z.o = point: new(1,1)
  z.ap,z.bp = get_points (z.o: symmetry (C.ab))
}
\begin{tikzpicture}
  \tkzGetNodes
  \tkzDrawCircles(a,b a',b')
  \tkzDrawLines(a,a' b,b')
  \tkzDrawLines[red](a,b a',b')
  \tkzDrawPoints(a,a',b,b',o)
  \tkzLabelPoints(a,a',b,b',o)
\end{tikzpicture}

```

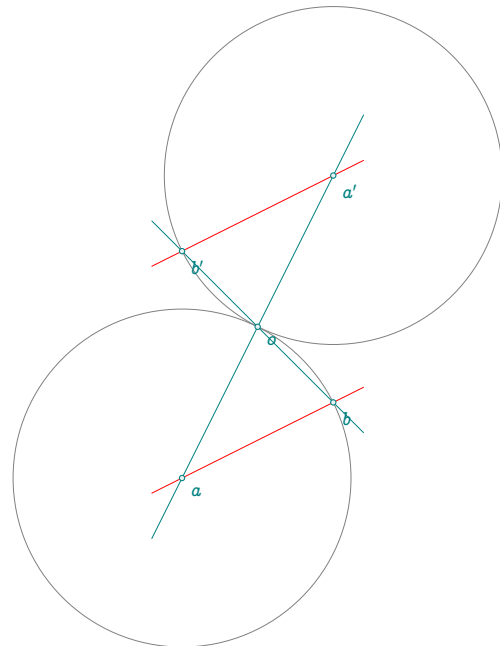

10 Class line

10.1 Attributes of a line

Writing `L.AB = line: new (z.A,z.B)` creates an object of the class **line** (the notation is arbitrary for the moment). Geometrically, it represents both the line passing through the points A and B as the segment $[AB]$. Thus, we can use the midpoint of $L.AB$, which is, of course, the midpoint of the segment $[AB]$. This medium is obtained with `L.AB.mid`. Note that `L.AB.pa = z.A` and `L.AB.pb = z.B`. Finally, if a line L is the result of a method, you can obtain the points with `z.A,z.B = get_points (L)` or with the previous remark.

Creation

```
L.AB = line : new ( z.A , z.B )
```

The attributes are :

Table 3: Line attributes.

Attributes	Application	
pa	First point of the segment	<code>z.A = L.AB.pa</code>
pb	Second point of the segment	
type	Type is 'line'	<code>L.AB.type = 'line'</code>
mid	Middle of the segment	<code>z.M = L.AB.mid</code>
slope	Slope of the line	[10.1.1]
length	<code>l = L.AB.length</code>	[22.9; 10.1.1]
north_pa		[10.1.1]
north_pb		
south_pa		
south_pb		
east		
west		
vec	<code>V.AB = L.AB.vec</code>	defines \overrightarrow{AB} [20]

10.1.1 Example: attributes of class line

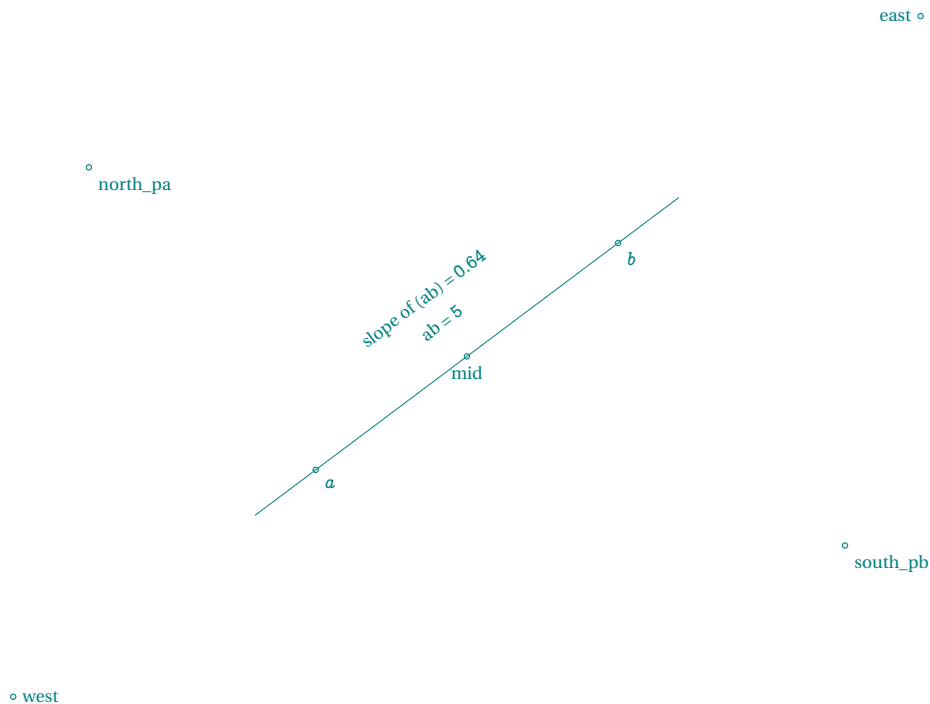

```

\directlua{%
init_elements ()
  z.a  = point: new (1, 1)
  z.b  = point: new (5, 4)
  L.ab = line : new (z.a,z.b)
  z.m  = L.ab.mid
  z.w  = L.ab.west
  z.e  = L.ab.east
  z.r  = L.ab.north_pa
  z.s  = L.ab.south_pb
  sl   = L.ab.slope
  len  = L.ab.length
}

\begin{tikzpicture}[scale = .75 ]
  \tkzGetNodes
  \tkzDrawPoints(a,b,m,e,r,s,w)
  \tkzLabelPoints(a,b,e,r,s,w)
  \tkzLabelPoints[above](m)
  \tkzDrawLine(a,b)
  \tkzLabelSegment[sloped](a,b){ab = \tkzUseLua{len}}
  \tkzLabelSegment[above=12pt,sloped](a,b){slope of (ab) = \tkzUseLua{sl}}
\end{tikzpicture}

```

10.1.2 Method new and line attributes

The notation can be L or L.AB or L.euler. The notation is actually free. L.AB can also represent the segment.

With `L.AB = line : new (z.A,z.B)`, a line is defined.

```

\directlua{%
init_elements ()
  z.A  = point : new (1,1)
  z.B  = point : new (3,2)
  L.AB = line : new (z.A,z.B)
  z.C  = L.AB.north_pa
  z.D  = L.AB.south_pa
}

\begin{tikzpicture}
  \tkzGetNodes
  \tkzDrawLines(A,B C,D)
  \tkzDrawPoints(A,...,D)
  \tkzLabelPoints(A,...,D)
  \tkzMarkRightAngle(B,A,C)
  \tkzMarkSegments(A,C A,B A,D)
\end{tikzpicture}

```

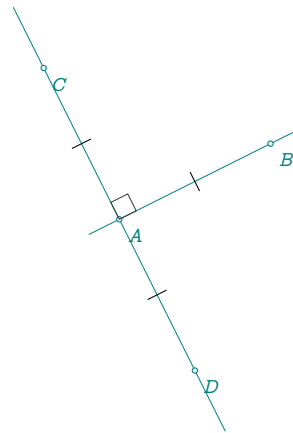

10.2 Methods of the class line

Here's the list of methods for the **line** object. The results can be real numbers, points, lines, circles or triangles. The triangles obtained are similar to the triangles defined below.

Table 4: Methods of the class line.(part 1)

Methods	Comments	
<code>new(pt, pt)</code>	<code>L.AB = line : new(z.A,z.B)</code>	Create line (AB) ; [26.5]
Real		
<code>distance (pt)</code>	<code>d = L.AB : distance (z.C)</code>	[10.2.1; 10.2.28]
<code>slope ()</code>	<code>a = L.AB : slope()</code>	better is <code>L.AB.slope</code> ; [10.1.1]
Boolean		
<code>in_out (pt)</code>	<code>b = L.AB: in_out(z.C)</code>	$b = \text{true}$ if $C \in (AB)$; [10.2.2; 24.7.1]
<code>in_out_segment(pt)</code>	<code>b = L.AB: in_out_segment(z.C)</code>	$b = \text{true}$ if $C \in [AB]$ [10.2.3]
<code>is_parallel(L)</code>		
<code>is_orthogonal(L)</code>		
<code>is_equidistant(pt)</code>		
Points		
<code>gold_ratio ()</code>	<code>z.C=L.AB : gold_ratio()</code>	[26.27; 4.3; 26.13]
<code>normalize ()</code>	<code>z.C=L.AB : normalize()</code>	$AC=1$ and $C \in (AB)$ [10.2.15]
<code>normalize_inv ()</code>	<code>z.C=L.AB : normalize_inv()</code>	$CB=1$ and $C \in (AB)$
<code>barycenter (r,r)</code>	<code>z.C=L.AB : barycenter (1,2)</code>	[10.2.16]
<code>point (r)</code>	<code>z.C=L.AB : point (2)</code>	$\vec{AC} = 2\vec{AB}$ [26.20; 10.2.13]
<code>midpoint ()</code>	<code>z.M=L.AB : midpoint ()</code>	better is <code>z.M = L.AB.mid</code>
<code>harmonic_int (pt)</code>	<code>z.D=L.AB : harmonic_int (z.C)</code>	[26.13]
<code>harmonic_ext (pt)</code>	<code>z.D=L.AB : harmonic_ext (z.C)</code>	[26.13]
<code>harmonic_both (r)</code>	<code>z.C,z.D=L.AB : harmonic_both(φ)</code>	[22.5]
<code>_east(d)</code>	<code>z.M=L.AB : _east(2)</code>	$BM = 2 A, B, M$ aligned
<code>_west(d)</code>	<code>z.M=L.AB : _east(2)</code>	$BM = 2 A, B, M$ aligned
<code>_north_pa(d)</code>	<code>z.M=L.AB: _north_pa(2)</code>	$AM=2; AM \perp AB$;
...	\vec{AB}, \vec{AM} counterclockwise	[10.2.17]
<code>_south_pa(d)</code>	<code>z.M=L.AB: _south_pa(2)</code>	$AM=2; AM \perp AB$; \vec{AB}, \vec{AM} clockwise
<code>_north_pb(d)</code>	<code>z.M=L.AB: _north_pb(2)</code>	$BM=2; BM \perp BA$; \vec{BA}, \vec{BM} clockwise
<code>_south_pb(d)</code>	<code>z.M=L.AB: _south_pb(2)</code>	$BM=2; BM \perp BA$;
...	\vec{AB}, \vec{AM} counterclockwise	[10.2.17]
<code>report(d,pt)</code>	<code>z.M=L.AB: report(2,z.N)</code>	$MN=2; AB \parallel MN$; [ex. 10.2.7]
<code>colinear_at(pt,k)</code>	<code>z.D=L.AB: colinear_at(z.C,2)</code>	$CD=2AB; AB \parallel CD$; [ex. 10.2.14]
Lines		
<code>ll_from (pt)</code>	<code>L.CD=L.AB: ll_from(z.C)</code>	$(CD) \parallel (AB)$; [10.2.17]
<code>ortho_from (pt)</code>	<code>L.CD=L.AB: ortho_from(z.C)</code>	$(CD) \perp (AB)$; [10.2.18]
<code>mediator ()</code>	<code>L.uv=L.AB: mediator()</code>	perpendicular bisector of (A,B) ^a ; [10.2.19]
<code>swap_line ()</code>	<code>L.AB=L.AB: swap_line()</code>	[10.2.20; 23.4.2]

^a You can use `perpendicular_bisector` instead of `mediator`.

Table 5: Methods of the class line.(part 2)

Methods	Comments	
Triangles		
equilateral (<swap>)	T.ABC=L.AB:equilateral()	$(\overrightarrow{AB}, \overrightarrow{AC}) > 0$ or < 0 with swap ^a ; [9.2.7]
isosceles (an<,swap>)	T.ABC=L.AB:isosceles(math.pi/6)	[10.2.9]
isosceles_a (an<,swap>)	same as isosceles	
isosceles_s (an<,swap>)	T.ABC=L.AB:isosceles_s(4) AC=BC	
two_angles (an,an)	T.ABC=L.AB:two_angles(an,an)	note ^b [10.2.8]
school ()	30°,60°,90°	
half (<swap>)	T.ABC=L.AB:half() $\hat{B} = 90^\circ$ and $2BC = AB$	
sss (r,r<,swap>)	$AC = r$ $BC = r$	[10.2.10]
sas (r,an<,swap>)	$AC = r$ $\widehat{BAC} = an$	[10.2.10]
ssa (r,an<,swap>)	$AC = r$ $\widehat{ABC} = an$	[10.2.10]
Squares		
square ()	S.AB=L.AB : square ()	create a square S.AB. ^c ; [9.2.7]
Sacred triangles		
gold (<swap>)	T.ABC=L.AB:gold()	right in B and $AC = \varphi \times AB$; [6]
euclide (<swap>)	T.ABC=L.AB:euclide()	$AB = AC$; $(\overrightarrow{AB}, \overrightarrow{AC}) = \pi/5$; [6]
golden (<swap>)	T.ABC=L.AB:golden()	$(\overrightarrow{AB}, \overrightarrow{AC}) = 2 \times \pi/5$; [6]
sublime (<swap>)	= golden	[6]
divine (<swap>)		[6]
golden_gnomon (<swap>)	= devine	[6]
egyptian (<swap>)		[6]
pythagoras (<swap>)	= egyptian	[6]
isis (<swap>)	= egyptian	[6]
cheops (<swap>)		[6]
Circles		
circle ()	C.AB = L.AB : circle ()	center pa through pb
apollonius (r)	C.apo = L.AB : apollonius (2)	Set of points tq. MA/MB = 2; [10.2.29]
c_l_pp (pt,pt)	C1,C2 = L.AB: c_l_pp(z.M,z.N)	[10.2.30]
c_ll_p (pt,pt)	C1,C2 = L.AB: c_ll_p(z.C,z.P)	[10.2.31]
Transformations		
reflection (obj)	new obj = L.AB : reflection (obj)	[10.2.27]
translation (obj)	new obj = L.AB : translation (obj)	[10.2.26]
projection (obj)	z.H = L.AB : projection (z.C)	$CH \perp (AB)$ and $H \in (AB)$;
...		[10.2.22; 10.2.25; 10.2.22; 10.2.25]
projection_ll(L,pts)	z.Mp=L.AB:projection_ll(L.CD,z.M)	[10.2.23]
affinity_ll(L,k,pts)	z.Mp=L.AB:affinity(L.CD,2,z.M)	[10.2.24]

^a Triangles are defined in the direct sense of rotation, unless the "swap" option is present.

^b The given side is between the two angles

^c _,_,z.C,z.D = get_points(S.AB)

10.2.1 Method distance

This method gives the distance from a point to a straight line.

```

\directlua{
function calc_distance (L,p)
  if L : in_out (p)
  then
    return point.abs(p-L.pa)/L.length
  else
    return 0
  end
end
z.A = point: new (0,0)
z.B = point: new (2,4)
z.X = point: new (3,6)
z.Y = point: new (2,0)
L.AB = line : new (z.A,z.B)
dx = calc_distance (L.AB,z.X)
dy = calc_distance (L.AB,z.Y)
}
\tkzUseLua{k}
\begin{tikzpicture}
\tkzGetNodes
\tkzDrawLine(A,B)
\tkzDrawPoints(A,B,X,Y)
\tkzLabelPoints(A,B)
\tkzLabelPoint(X){X : \tkzUseLua{dx}}
\tkzLabelPoint(Y){Y : \tkzUseLua{dy}}
\end{tikzpicture}

```

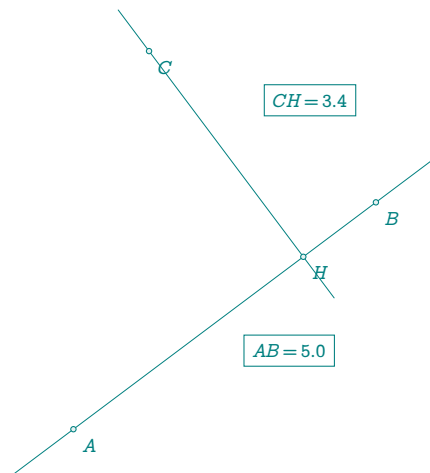

10.2.2 Method in_out

This method shows whether a point belongs to a straight line.

```

\directlua{
function calc_ratio (L,p)
  if L : in_out (p)
  then
    return point.abs(p-L.pa)/L.length
  else
    return 0
  end
end
z.A = point: new (0,0)
z.B = point: new (2,4)
z.X = point: new (3,6)
z.Y = point: new (2,0)
L.AB = line : new (z.A,z.B)
dx = calc_ratio (L.AB,z.X)
dy = calc_ratio (L.AB,z.Y)
}
\begin{tikzpicture}
\tkzGetNodes
\tkzDrawLine(A,B)
\tkzDrawPoints(A,B,X,Y)
\tkzLabelPoints(A,B)
\tkzLabelPoint(X){X : \tkzUseLua{dx}}
\tkzLabelPoint(Y){Y : \tkzUseLua{dy}}
\end{tikzpicture}

```

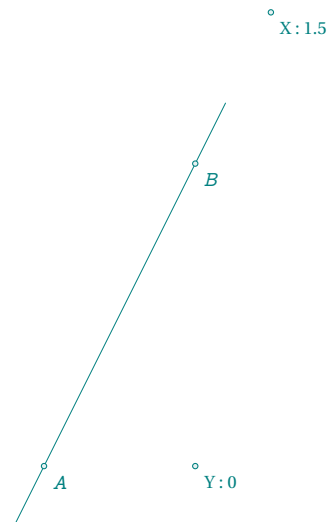

10.2.3 Method `in_in_out_segment`

Variant of the previous method; indicates whether a point is on or off a segment.

```

\directlua{
function foo (L,p)
  if L : in_out_segment (p)
  then
    return "in"
  else
    return "out"
  end
end
z.A      = point: new (0,0)
z.B      = point: new (2,4)
z.X      = point: new (-1,-2)
z.Y      = point: new (1,2)
L.AB     = line : new (z.A,z.B)
bx       = foo(L.AB,z.X)
by       = foo(L.AB,z.Y)
}
\begin{tikzpicture}
  \tkzGetNodes
  \tkzDrawLine(A,B)
  \tkzDrawPoints(A,B,X,Y)
  \tkzLabelPoints(A,B)
  \tkzLabelPoint(X){X : \tkzUseLua{bx}}
  \tkzLabelPoint(Y){Y : \tkzUseLua{by}}
\end{tikzpicture}

```

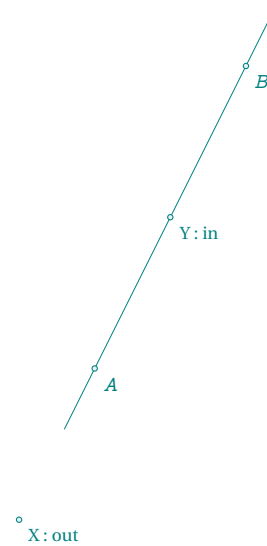

10.2.4 Method `is_parallel`

```

\directlua{
z.A = point : new ( 0 , 0 )
z.B = point : new ( 4 , 2 )
L.AB = line : new (z.A,z.B)
z.C = point : new ( 1 , 2 )
z.D = point : new ( 5 , 4 )
L.CD = line : new (z.C,z.D)
if L.AB:is_parallel (L.CD)
then tex.print("parallel")
else tex.print("no parallel")
end
}
\begin{tikzpicture}
\tkzGetNodes
\tkzDrawLines(A,B C,D)
\tkzDrawPoints(A,B,C,D)
\tkzLabelPoints(A,B,C,D)
\end{tikzpicture}

```

parallel

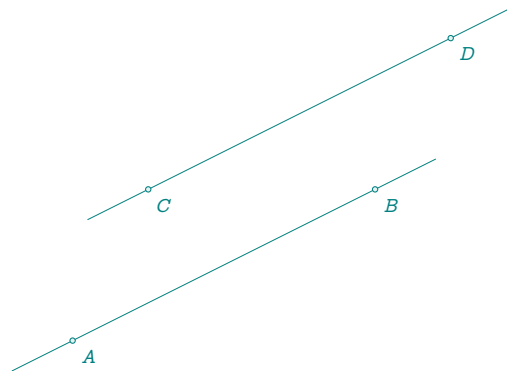

10.2.5 Method `is_orthogonal`

```

\directlua{
z.A = point : new ( 0 , 0 )
z.B = point : new ( 0 , 4 )
L.AB = line : new ( z.A,z.B )
z.C = point : new ( 3 , 4 )
L.BC = line : new ( z.B,z.C )
if L.AB:is_orthogonal (L.BC)
then tex.print("orthogonal")
else tex.print("no orthogonal")
end
}
\begin{tikzpicture}
\tkzGetNodes
\tkzDrawLines(A,B B,C A,C)
\tkzDrawPoints(A,B,C)
\tkzLabelPoints(A,B,C)
\end{tikzpicture}

```

orthogonal

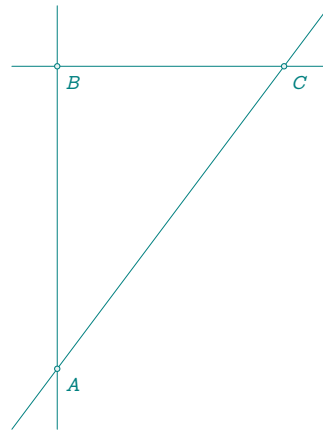
10.2.6 Method `is_equidistant`

```

\directlua{
z.A = point : new ( 0 , 0 )
z.B = point : new ( 0 , 4 )
z.C = point : new ( 4 , 4 )
L.AC = line : new ( z.A,z.C )
if L.AC:is_equidistant (z.B)
then tex.print("equidistant")
else tex.print("no equidistant")
end
}
\begin{tikzpicture}
\tkzGetNodes
\tkzDrawLines(A,B B,C A,C)
\tkzDrawPoints(A,B,C)
\tkzLabelPoints(A,B,C)
\end{tikzpicture}

```

equidistant

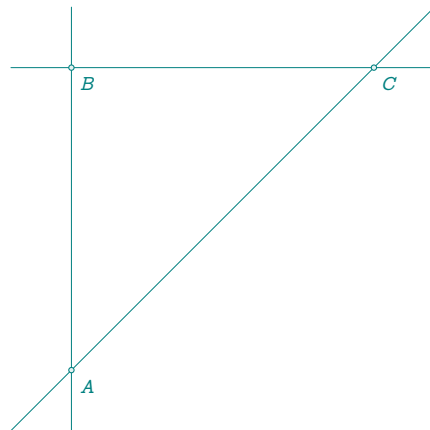
10.2.7 Method `report`

`report (d,pt)` If the point is absent, the transfer is made from the first point that defines the line.

```

\directlua{%
init_elements ()
z.A = point : new (0,0)
z.B = point : new (4,3)
L.AB = line : new ( z.A , z.B )
z.M = point : new (0,2)
z.N = L.AB : report (2.5,z.M)
z.O = L.AB : report (2.5)
}
\begin{tikzpicture}
\tkzGetNodes
\tkzDrawSegments(A,B M,N)
\tkzDrawPoints(A,B,M,N,O)
\tkzLabelPoints(A,B,M,N,O)
\end{tikzpicture}

```

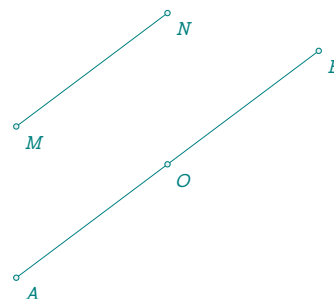

10.2.8 Method two_angles

The angles are on either side of the given segment

```
\directlua{%
init_elements ()
  z.A = point : new ( 0 , 0 )
  z.B = point : new ( 4 , 0 )
  L.AB = line : new ( z.A , z.B )
  T.ABC = L.AB : two_angles (math.pi/6,math.pi/2)
  z.C = T.ABC.pc
}
\begin{tikzpicture}
  \tkzGetNodes
  \tkzDrawPolygons(A,B,C)
  \tkzDrawPoints(A,B,C)
  \tkzLabelPoints(A,B)
  \tkzLabelPoints[above](C)
  \tkzMarkAngle[red](C,B,A)
  \tkzMarkAngle[red](B,A,C)
  \tkzLabelAngle[red,pos=1.3](C,B,A){$\pi/2$}
  \tkzLabelAngle[red,pos=1.3](B,A,C){$\pi/6$}
\end{tikzpicture}
```

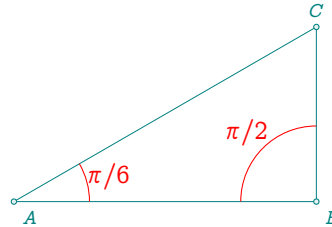

10.2.9 Method isosceles

```
\directlua{%
init_elements ()
  z.a = point : new (1,2)
  z.b = point : new (5,1)
  L.ab = line : new (z.a,z.b)
  T.abc = L.ab : isosceles (math.pi/6,indirect)
  z.c = T.abc.pc
  z.L = T.abc : lemoine_point ()
  T.SY = T.abc : symmedian ()
  z.Ka,
  z.Kb,
  z.Kc = get_points (T.SY)
  L.Kb = T.abc : symmedian_line (1)
  _,z.Kb = get_points(L.Kb)
}
\begin{tikzpicture}[scale= 2]
  \tkzGetNodes
  \tkzDrawPolygons(a,b,c Ka,Kb,Kc)
  \tkzDrawPoints(a,b,c,L,Ka,Kb,Kc)
  \tkzLabelPoints(c,L,Ka,Kb)
  \tkzLabelPoints[above](a,b,Kc)
  \tkzDrawSegments[cyan](a,Ka b,Kb c,Kc)
\end{tikzpicture}
```

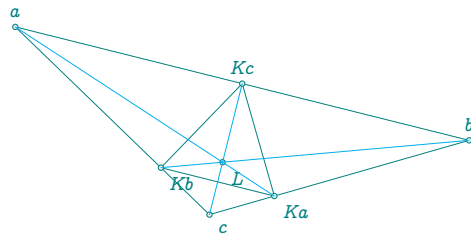

10.2.10 Methods sss, sas, ssa

In the following example, a small difficulty arises. The given lengths are not affected by scaling, so it's necessary to use the value (r) function, which will modify the lengths according to the scale.

```

\directlua{%
init_elements ()
  z.A = point : new ( 0 , 0 )
  z.B = point : new ( 5 , 0 )
  L.AB = line : new ( z.A , z.B )
  T.ABC = L.AB : sss (value(3),value(4))
  T.ABD = L.AB : sas (value(3),math.pi/2)
  T.ABE = L.AB : ssa (value(7),math.pi/2)
  z.C = T.ABC.pc
  z.D = T.ABD.pc
  z.E = T.ABE.pc
}
\begin{tikzpicture}[gridded]
  \tkzGetNodes
  \tkzDrawPolygons(A,B,C A,B,D A,B,E)
  \tkzDrawPoints(A,B,C,D,E)
  \tkzLabelPoints(A,B)
  \tkzLabelPoints[above] (C,D,E)
\end{tikzpicture}

```

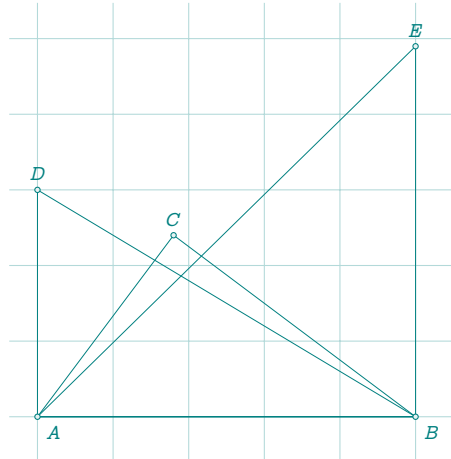

10.2.11 Triangle with side between side and angle

```

\directlua{%
init_elements ()
  z.A = point: new ( 0 , 0 )
  z.B = point: new ( 5 , 0 )
  L.AB = line: new ( z.A , z.B )
  T.ABC= L.AB: ssa(value(3),math.pi/6)
  T.ABD= L.AB: ssa(value(3),math.pi/6,swap)
  z.C = T.ABC.pc
  z.D = T.ABD.pc
}
\begin{tikzpicture}[gridded]
  \tkzGetNodes
  \tkzDrawPolygons(A,B,C A,B,D)
  \tkzDrawPoints(A,B,C,D)
  \tkzLabelPoints(A,B)
  \tkzLabelPoints[above] (C,D)
  \tkzLabelAngle[teal] (C,B,A){$\pi/6$}
  \tkzLabelSegment[below left] (A,C){$7$}
  \tkzLabelSegment[below left] (A,D){$7$}
\end{tikzpicture}

```

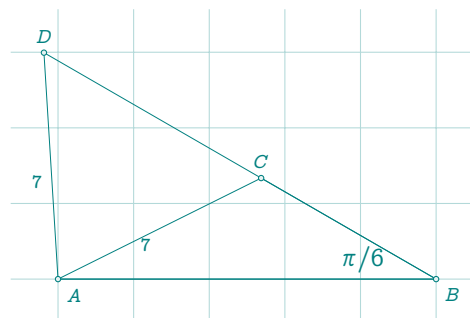

10.2.12 About sacred triangles

The side lengths are proportional to the lengths given in the table. They depend on the length of the initial segment.

Table 6: Sacred triangles.

Name	definition
gold (<swap>)	Right triangle with $a = \varphi$, $b = 1$ and $c = \sqrt{\varphi}$
golden (<swap>)	Right triangle $b = \varphi$, $c = 1$; half of gold rectangle
divine ()	Isosceles $a = \varphi$, $b = c = 1$ and $\beta = \gamma = \pi/5$
pythagoras ()	$a = 5$, $b = 4$, $c = 3$ and other names: isis or egyptian
sublime ()	Isosceles $a = 1$, $b = c = \varphi$ and $\beta = \gamma = 2\pi/5$; other name: euclid
cheops ()	Isosceles $a = 2$, $b = c = \varphi$ and height = $\sqrt{\varphi}$

```

\directlua{%
init_elements ()
  z.A = point : new ( 0 , 0 )
  z.B = point : new ( 4 , 0 )
  L.AB = line : new ( z.A , z.B )
  T.ABC = L.AB : cheops ()
  z.C = T.ABC.pc
  T.ABD = L.AB : gold ()
  z.D = T.ABD.pc
  T.ABE = L.AB : euclide ()
  z.E = T.ABE.pc
  T.ABF = L.AB : golden ()
  z.F = T.ABF.pc
  T.ABG = L.AB : divine ()
  z.G = T.ABG.pc
  T.ABH = L.AB : pythagoras ()
  z.H = T.ABH.pc
}
\begin{tikzpicture}
  \tkzGetNodes
  \tkzDrawPolygons(A,B,C A,B,D A,B,E A,B,F A,B,G A,B,H)
  \tkzDrawPoints(A,...,H)
  \tkzLabelPoints(A,...,H)
\end{tikzpicture}

```

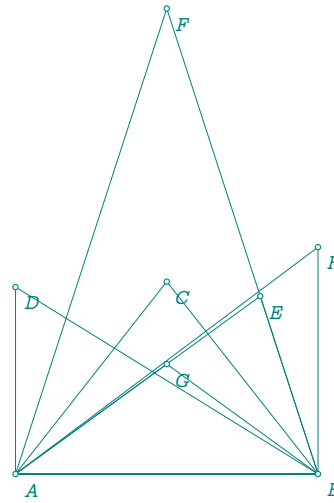

10.2.13 Method point

This method is very useful. It allows you to place a point on the line under consideration. If $r = 0$ then the point is p_a , if $r = 1$ it's p_b .

If $r = .5$ the point obtained is the midpoint of the segment. r can be negative or greater than 1.

This method exists for all objects except quadrilaterals.

```

\directlua{%
init_elements ()
  z.A = point : new (-1,-1)
  z.B = point : new (1,1)
  L.AB = line : new (z.A,z.B)
  z.I = L.AB : point (0.5)
  z.J = L.AB : point (-0.5)
  z.K = L.AB : point (2)
}
\begin{tikzpicture}[gridded]
  \tkzDrawLine(J,K)
  \tkzDrawPoints(A,B,I,J,K)
  \tkzLabelPoints(A,B,I,J,K)
\end{tikzpicture}

```

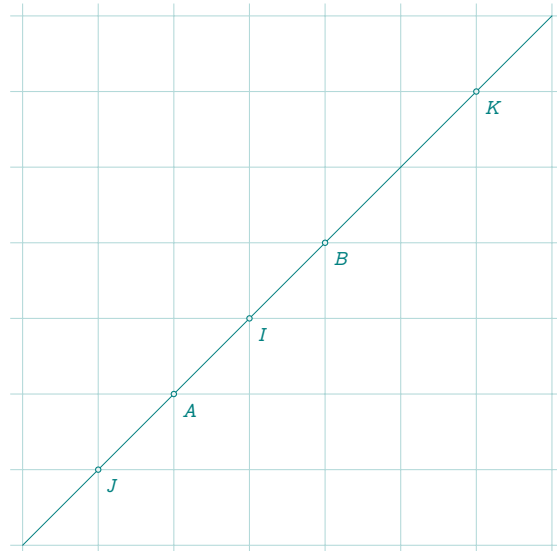

10.2.14 Method colinear_at

If the coefficient is missing then it defaults to 1 and in the following example we obtain: $CE = AB$ and $(AB) \parallel (CE)$. For point D : $CD = .5AB$ and $(AB) \parallel (CD)$.

```

\directlua{%
init_elements ()
  z.A = point: new (0 , 0)
  z.B = point: new (4 , 0)
  z.C = point: new (1 , 3)
  L.AB = line : new (z.A,z.B)
  z.D = L.AB : colinear_at (z.C,.5)
  z.E = L.AB : colinear_at (z.C)
}
\begin{tikzpicture}
  \tkzGetNodes
  \tkzDrawSegments(A,B C,E)
  \tkzDrawPoints(A,B,C,D,E)
  \tkzLabelPoints(A,B,C,D,E)
\end{tikzpicture}

```



10.2.15 Method normalize

```

\directlua{%
init_elements ()
  z.a = point: new (1, 1)
  z.b = point: new (5, 4)
  L.ab = line : new (z.a,z.b)
  z.c = L.ab : normalize ()
}

```

```

\begin{tikzpicture}[gridded]
  \tkzGetNodes
  \tkzDrawSegments(a,b)
  \tkzDrawCircle(a,c)
  \tkzDrawPoints(a,b,c)
  \tkzLabelPoints(a,b,c)
\end{tikzpicture}

```

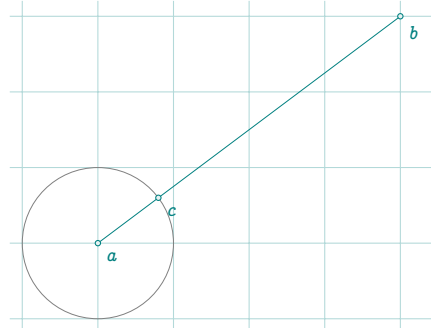

10.2.16 Method barycenter

```

\directlua{%
init_elements ()
  z.A = point : new ( 0 , -1 )
  z.B = point : new ( 4 , 2 )
  L.AB = line : new ( z.A , z.B )
  z.G = L.AB : barycenter (1,2)
}
\begin{tikzpicture}
  \tkzGetNodes
  \tkzDrawLine(A,B)
  \tkzDrawPoints(A,B,G)
  \tkzLabelPoints(A,B,G)
\end{tikzpicture}

```

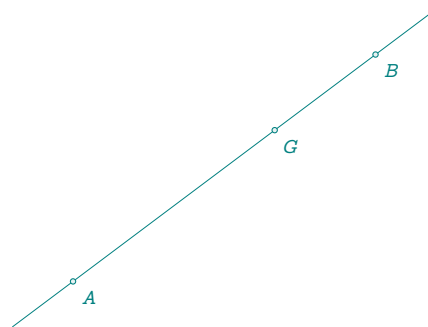

10.2.17 Method ll_from

```

\directlua{%
init_elements ()
z.A = point : new (1,1)
z.B = point : new (3,2)
L.AB = line : new (z.A,z.B)
z.C = L.AB.north_pa
z.D = L.AB.south_pa
L.CD = line : new (z.C,z.D)
_,z.E = get_points ( L.CD: ll_from (z.B))
% z.E = L2.pb
}
\begin{tikzpicture}[scale = 1.25]
\tkzGetNodes
\tkzDrawLines(A,B C,D B,E)
\tkzDrawPoints(A,...,E)
\tkzLabelPoints(A,...,E)
\tkzMarkRightAngle(B,A,C)
\tkzMarkSegments(A,C A,B A,D)
\end{tikzpicture}

```

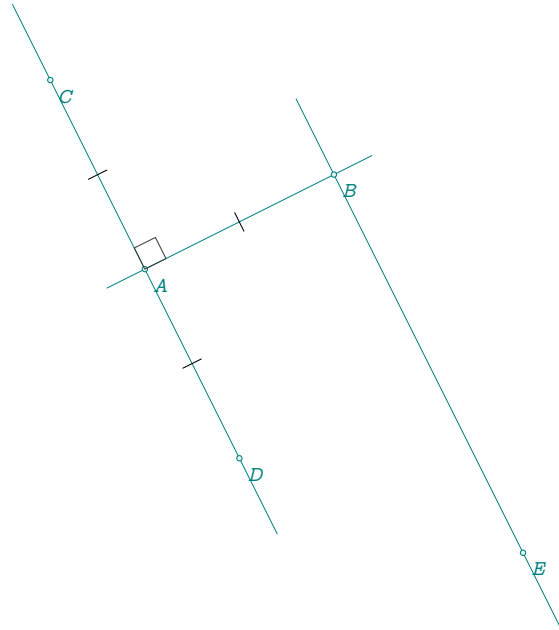

10.2.18 Method ortho_from

```

\directlua{%
init_elements ()
z.A = point : new (1,1)
z.B = point : new (3,2)
L.AB = line : new (z.A,z.B)
z.C = point : new (1,3)
L.CD = L.AB : ortho_from(z.C)
z.D = L.CD.pb
}
\begin{tikzpicture}
\tkzGetNodes
\tkzDrawLines(A,B C,D)
\tkzDrawPoints(A,...,D)
\tkzLabelPoints(A,...,D)
\end{tikzpicture}

```

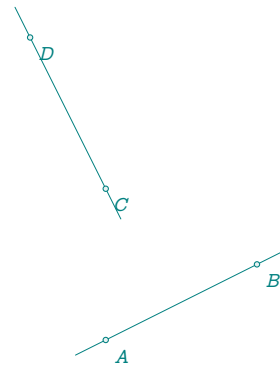

10.2.19 Method mediator

In Mathworld, the mediator is the plane through the midpoint of a line segment and perpendicular to that segment, also called a mediating plane. The term "mediator" was introduced by J. Neuberg (Altshiller-Court 1979, p. 298). Here, I have adopted the French term and the mediator or the perpendicular bisector of a line segment, is a line segment perpendicular to the segment and passing through the midpoint of this segment.

```

\directlua{%
init_elements ()
  z.A   = point: new(0,0)
  z.B   = point: new(5,0)
  L.AB  = line: new (z.A,z.B)
  L.med = L.AB : mediator ()
  z.M   = L.AB.mid
  z.x,z.y= get_points(L.med)
}
\begin{tikzpicture}
\tkzGetNodes
\tkzDrawLine(A,B)
\tkzDrawSegments(x,y)
\tkzDrawPoints(A,B,M)
\tkzLabelPoints(A,B)
\tkzLabelPoints[below left](x,y,M)
\tkzMarkSegments(A,M M,B)
\end{tikzpicture}

```

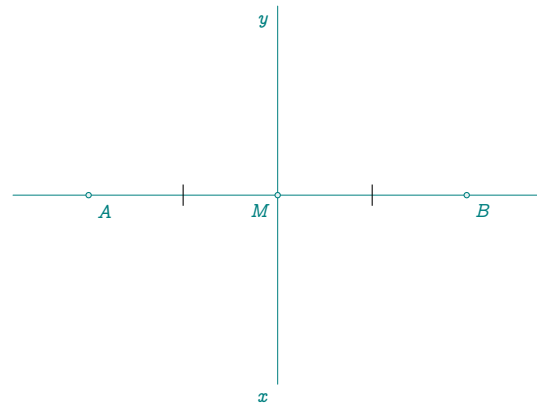

10.2.20 Method swap_line

Sometimes it's useful to swap the two points that define a straight line. This allows you to change the orientation. A more important example is shown here [23.4.2].

```

\directlua{
init_elements ()
z.A = point : new ( 0 , 0 )
z.B = point : new ( 2 , -1 )
L.dir = line : new (z.A,z.B)
L.dir = L.dir: swap_line()
z.a = L.dir.pa
z.b = L.dir.pb
}
\begin{tikzpicture}
\tkzGetNodes
\tkzDrawSegments[cyan,thick,->](a,b)
\tkzLabelPoints(A,B)
\end{tikzpicture}

```

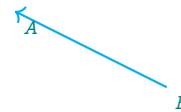

10.2.21 Method equilateral

```

\directlua{%
init_elements ()
  z.A   = point: new(0,0)
  z.B   = point: new(5,0)
  L.AB  = line: new (z.A,z.B)
  T.ABC = L.AB : equilateral ()
  z.C   = T.ABC.pc
}
\begin{tikzpicture}
\tkzGetNodes
\tkzDrawLine(A,B)
\tkzDrawPolygon(A,B,C)
\tkzMarkSegments(A,B B,C C,A)
\tkzDrawPoints(A,B,C)
\tkzMarkAngles(B,A,C C,B,A A,C,B)
\end{tikzpicture}

```

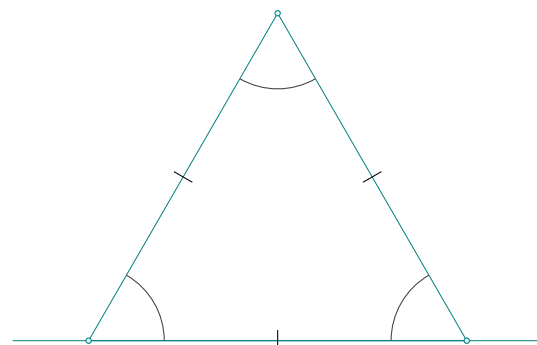

10.2.22 Method projection

```

\directlua{
init_elements ()
  z.a      = point: new (0, 0)
  z.b      = point: new (4, 1)
  z.c      = point: new (2, 5)
  z.d      = point: new (5, 2)
  L.ab     = line:  new (z.a,z.b)
  z.cp,z.dp = L.ab: projection(z.c,z.d)
}
\begin{tikzpicture}[scale = .8]
  \tkzGetNodes
  \tkzDrawLines(a,b c,c' d,d')
  \tkzDrawPoints(a,...,d,c',d')
  \tkzLabelPoints(a,...,d,c',d')
\end{tikzpicture}

```

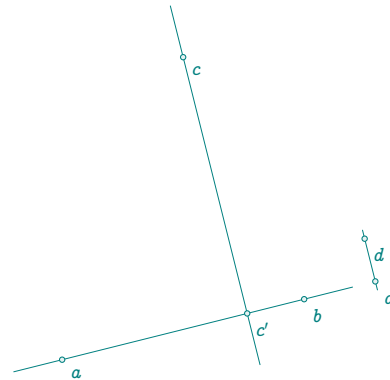

10.2.23 Method projection_ll

We've just seen (orthogonal) projection, but this time we're talking about projecting a point onto a line parallel to a line. At present, this transformation only applies to a point or a group of points, but it will be extended to objects.

```

\directlua{
  z.a = point: new (0, 0)
  z.b = point: new (4, 1)
  z.c = point: new (-1, 3)
  z.d = point: new (-2, -1)
  z.m = point: new (1,2)
  z.n = point: new (3,2)
  L.ab = line: new (z.a,z.b)
  L.cd = line: new (z.c,z.d)
  z.e,z.f= L.ab:projection_ll(L.cd,z.m,z.n)
}
\begin{tikzpicture}
\tkzGetNodes
\tkzDrawLines(a,b c,d e,m f,n)
\tkzDrawPoints(a,...,f,m,n)
\tkzLabelPoints(a,...,f,m,n)
\end{tikzpicture}

```

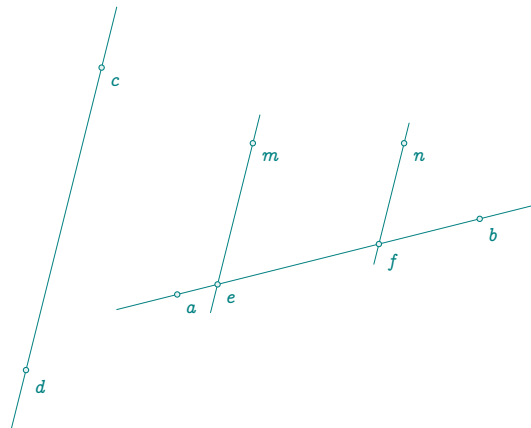

10.2.24 Method affinity

The introduction of parallel projection to an axis allows us to define a new transformation: affinity.

```

\directlua{
  z.a = point: new (0, 0)
  z.b = point: new (4, 1)
  z.c = point: new (-1, 3)
  z.d = point: new (-2, -1)
  z.m = point: new (1,2)
  z.n = point: new (3,2)
  L.ab = line: new (z.a,z.b)
  L.cd = line: new (z.c,z.d)
  z.e,z.f= L.ab:projection_ll(L.cd,z.m,z.n)
  z.g,z.h = L.ab : affinity(L.cd,2,z.m,z.n)}
\begin{tikzpicture}
  \tkzGetNodes
  \tkzDrawLines(a,b c,d e,m f,n)
  \tkzDrawPoints(a,...,h,m,n)
  \tkzLabelPoints(a,...,h,m,n)
\end{tikzpicture}

```

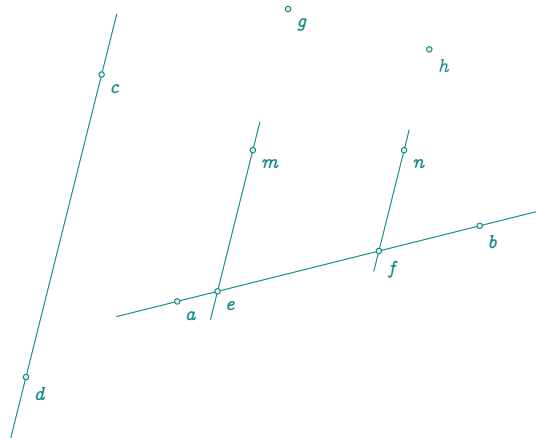

10.2.25 Example: combination of methods

```

\directlua{%
init_elements ()
  z.A      = point: new (0 , 0)
  z.B      = point: new (6 , 0)
  z.C      = point: new (1 , 5)
  T.ABC    = triangle: new (z.A,z.B,z.C)
  L.AB     = T.ABC.ab
  z.O      = T.ABC.circumcenter
  C.OA     = circle: new (z.O,z.A)
  z.H      = L.AB: projection (z.O)
  L.ab     = C.OA: tangent_at (z.A)
  z.a,z.b = L.ab.pa,L.ab.pb
  % or z.a,z.b = get_points (L.ab)
}

```

```

\begin{tikzpicture}
  \tkzGetNodes
  \tkzDrawPolygon(A,B,C)
  \tkzDrawCircle(O,A)
  \tkzDrawSegments[purple](O,A O,B O,H)
  \tkzDrawArc[red](O,A)(B)
  \tkzDrawArc[blue](O,B)(A)
  \tkzDrawLine[add = 2 and 1](A,a)
  \tkzFillAngles[teal!30,opacity=.4](A,C,B b,A,B A,O,H)
  \tkzMarkAngles[mark=|](A,C,B b,A,B A,O,H H,O,B)
  \tkzDrawPoints(A,B,C,H,O)
  \tkzLabelPoints(B,H)
  \tkzLabelPoints[above](O,C)
  \tkzLabelPoints[left](A)
\end{tikzpicture}

```

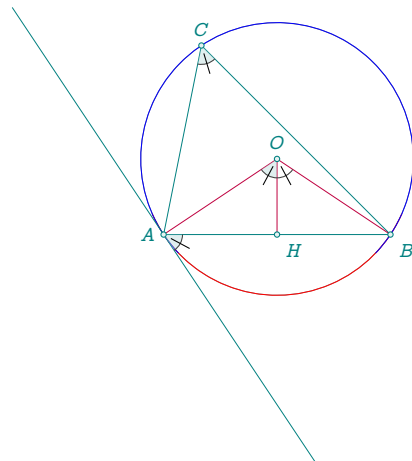

10.2.26 Method translation

```

\directlua{%
init_elements ()
  z.A = point: new (0,0)
  z.B = point: new (1,2)
  z.C = point: new (-3,2)
  z.D = point: new (0,2)
  L.AB = line : new (z.A,z.B)
  z.E,z.F = L.AB : translation (z.C,z.D)
}
\begin{tikzpicture}
\tkzGetNodes
\tkzDrawPoints(A,...,F)
\tkzLabelPoints(A,...,F)
\tkzDrawSegments[->,red,> =latex](C,E D,F A,B)
\end{tikzpicture}

```

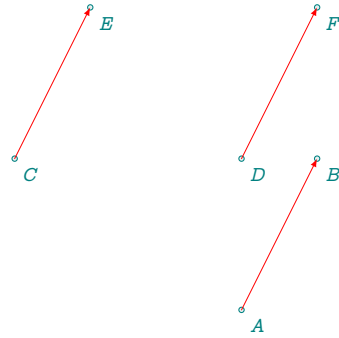

10.2.27 Method reflection of an object

```

\directlua{%
init_elements ()
  z.A = point : new ( 0 , 0 )
  z.B = point : new ( 4 , 1 )
  z.E = point : new ( 0 , 2 )
  z.F = point : new ( 3 , 3 )
  z.G = point : new ( 4 , 2 )
  L.AB = line : new ( z.A , z.B )
  T.EFG = triangle : new (z.E,z.F,z.G)
  T.new = L.AB : reflection (T.EFG)
  z.Ep,z.Fp,z.Gp = get_points(T.new)
}
\begin{tikzpicture}
\tkzGetNodes
\tkzDrawLine(A,B)
\tkzDrawPolygon(E,F,G)
\tkzDrawPolygon[new](E',F',G')
\tkzDrawSegment[red,dashed](E,E')
\end{tikzpicture}

```

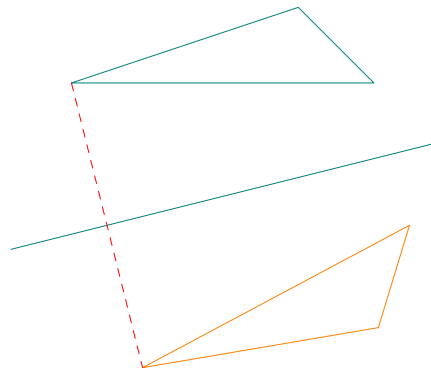

10.2.28 Method distance

```

\directlua{%
init_elements ()
  z.A = point : new ( 0 , 0)
  z.B = point : new ( 4 , -2)
  z.C = point : new ( 3 , 3)
  L.AB = line : new (z.A,z.B)
  d = L.AB : distance (z.C)
  z.H = L.AB : projection (z.C)
}
\begin{tikzpicture}
  \tkzGetNodes
  \tkzDrawLines(A,B C,H)
  \tkzDrawPoints(A,B,C,H)
  \tkzLabelPoints(A,B,C,H)
  \tkzLabelSegment[above left,
  draw](C,H){$CH = \tkzUseLua{d}$}
\end{tikzpicture}

```

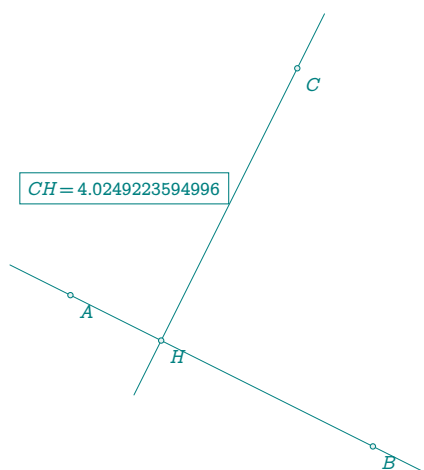
10.2.29 Method apollonius (Apollonius circle $MA/MB = k$)

```

\directlua{%
init_elements ()
  z.A = point : new ( 0 , 0 )
  z.B = point : new ( 6 , 0 )
  L.AB =line: new (z.A,z.B)
  C.apo = L.AB : apollonius (2)
  z.O,z.C = get_points ( C.apo )
  z.D = C.apo : antipode (z.C)
  z.P = C.apo : point (0.30)
}
\begin{tikzpicture}
  \tkzGetNodes
  \tkzFillCircle[blue!20,opacity=.2](O,C)
  \tkzDrawCircle[blue!50!black](O,C)
  \tkzDrawPoints(A,B,O,C,D,P)
  \tkzDrawSegments[orange](P,A P,B P,D B,D P,C)
  \tkzDrawSegments[red](A,C)
  \tkzDrawPoints(A,B)
  \tkzLabelCircle[draw,fill=green!10,%
  text width=3cm,text centered,left=24pt](O,D)(60)%
  {$CA/CB=2$\$PA/PB=2$\$DA/DB=2$}
  \tkzLabelPoints[below right](A,B,O,C,D)
  \tkzLabelPoints[above](P)
  \tkzMarkRightAngle[opacity=.3,fill=lightgray](D,P,C)
  \tkzMarkAngles[mark=| |](A,P,D D,P,B)
\end{tikzpicture}

```

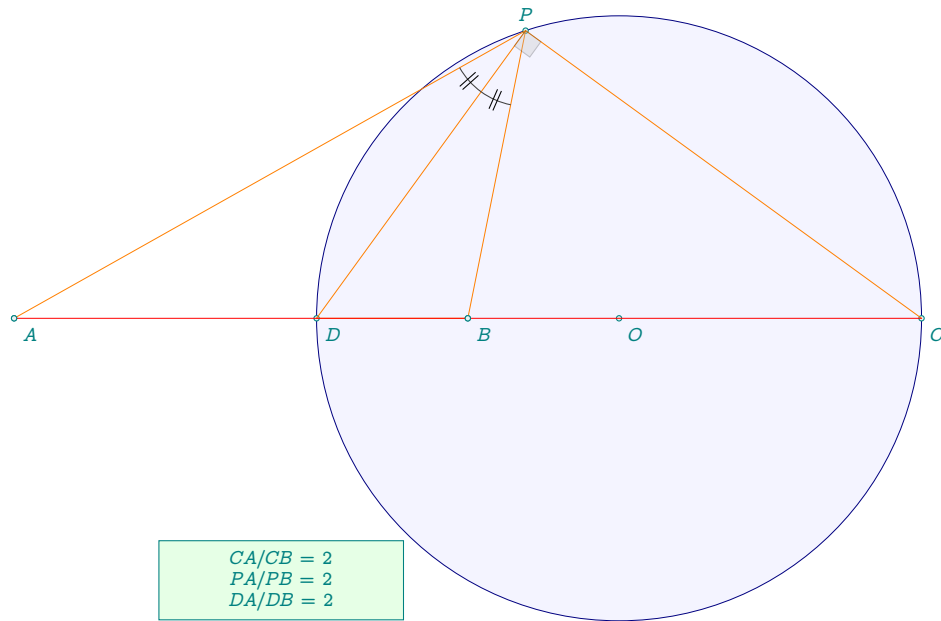

Remark: $\text{\tkzUseLua}\{\text{length}(z.P, z.A)/\text{length}(z.P, z.B)\} = 2.0$

10.2.30 Method `c_l_pp`

Circle tangent to a line passing through two points.

First, consider the general case: a straight line (AB) and two points, M and N . We are tasked with finding the circle that is tangent to the line and passes through the two points.

We will focus on the straight line (AB) and apply a specific method designed for such cases. The method takes into account the following special cases:

- line (MN) is perpendicular to the line (AB) ;
- line (MN) is parallel to line (AB) ;
- these points are on either side of the line (AB) ;
- one of the points lies on the line (AB) .

```

\directlua{
init_elements ()
z.A   = point : new ( 0 , 0 )
z.B   = point : new ( 8 , 0 )
z.M   = point : new ( 1 , 1 )
z.N   = point : new ( 2 , 5 )
L.AB  = line:new(z.A,z.B)
C1,C2 = L.AB : c_l_pp (z.M,z.N)
z.O1  = C1.center
z.O2  = C2.center
z.T1  = C1.through
z.T2  = C2.through
}
\begin{tikzpicture}[scale = .75]
\tkzGetNodes
\tkzDrawLines(A,B M,N)
\tkzDrawCircles(O1,T1 O2,T2)
\tkzDrawPoints(A,B,M,N)
\tkzLabelPoints(A,B,M,N)
\tkzDrawPoints(A,B,M,N,O1,T1,O2,T2)
\end{tikzpicture}

```

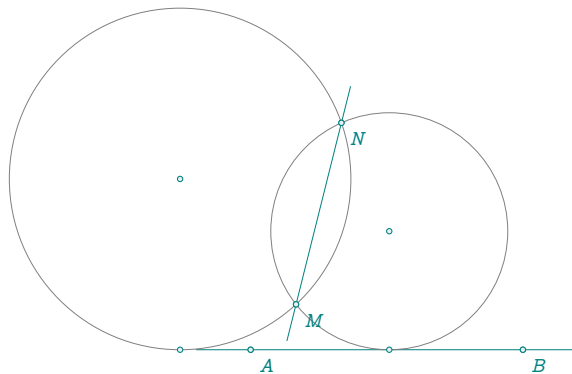

Let's look at the impossible case: the points are on either side of the line.

The method returns nil and nil.

```

\directlua{
init_elements ()
z.A   = point :new (0, 0)
z.B   = point :new (6, 0)
z.M   = point :new (1, 1)
z.N   = point :new (3, -5)
L.AB  = line:new(z.A,z.B)
L.MN  = line:new(z.M,z.N)
z.I   = intersection(L.AB,L.MN)
C1,C2 = L.AB : c_l_pp(z.M,z.N)
if C1 == nil
then
else
z.C   = C1.center
z.Cp  = C2.center
z.T   = C1.through
z.Tp  = C2.through
end
}
\begin{tikzpicture}[scale = .6]
\tkzGetNodes
\tkzDrawLines(A,B M,N)
\tkzDrawPoints(A,B,M,N)
\tkzLabelPoints(A,B,M,N)
\end{tikzpicture}

```

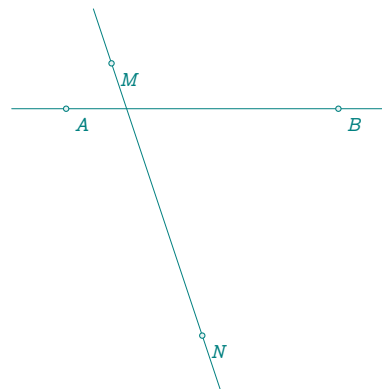

Let's look at the case where the line (MN) is parallel to the initial line.

```

\directlua{
init_elements ()
z.A   = point : new ( 0 , 0 )
z.B   = point : new ( 6 , 0 )
z.M   = point : new ( 0 , 3 )
z.N   = point : new ( 5 , 3 )
L.AB  = line:new(z.A,z.B)
C1,C2 = L.AB : c_l_pp(z.M,z.N)
z.O1  = C1.center
z.O2  = C2.center
z.T1  = C1.through
z.T2  = C2.through
}
\begin{tikzpicture}
\tkzGetNodes
\tkzDrawSegments(A,B M,N)
\tkzDrawCircles(O1,T1)
\tkzDrawPoints(A,B,M,N)
\tkzDrawPoints(A,B,M,N)
\tkzLabelPoints(A,B,M,N)
\end{tikzpicture}

```

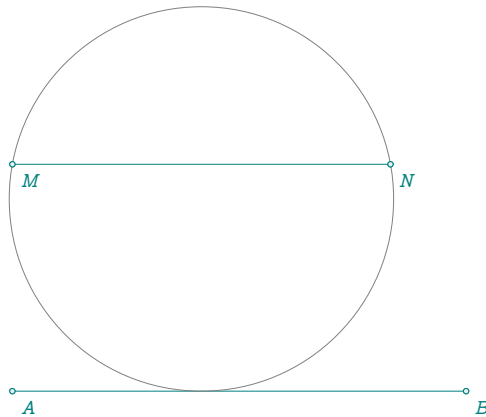

Where the line is perpendicular to the initial line.

```

\directlua{
init_elements ()
z.A   = point : new(0, 0 )
z.B   = point : new(6, 0 )
z.M   = point : new(1, 1 )
z.N   = point : new(1, 5 )
L.AB  = line:new(z.A,z.B)
C1,C2 = L.AB : c_l_pp(z.M,z.N)
z.O1  = C1.center
z.O2  = C2.center
z.T1  = C1.through
z.T2  = C2.through
}

```

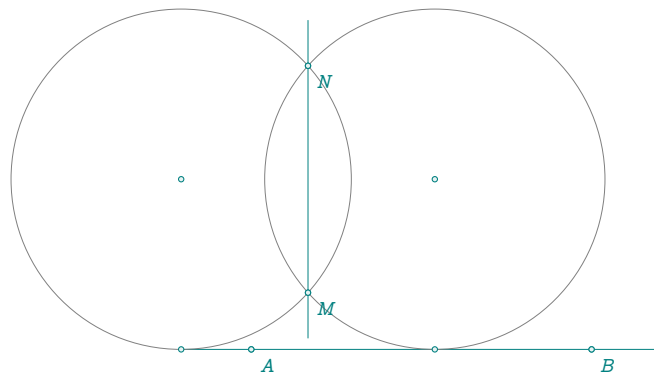

The last special case is when one of the points is on the initial line. In this case, there's only one solution.

```

\directlua{
init_elements ()
z.A   = point : new ( 0 , 0 )
z.B   = point : new ( 5 , 0 )
z.M   = point : new ( 1 , 0 )
z.N   = point : new ( 3 , 5 )
L.AB  = line:new(z.A,z.B)
L.MN  = line:new(z.M,z.N)
z.I   = intersection(L.AB,L.MN)
C1,C2 = L.AB : c_l_pp(z.M,z.N)
z.O1  = C1.center
z.O2  = C2.center
z.T1  = C1.through
z.T2  = C2.through
}
\begin{tikzpicture}
\tkzGetNodes
\tkzDrawLines(A,B M,N)
\tkzDrawCircles(O1,T1 O2,T2)
\tkzDrawPoints(A,B,M,N)
\tkzLabelPoints(A,B,M,N)
\tkzDrawPoints(A,B,M,N,O1,T1,O2,T2)
\end{tikzpicture}

```

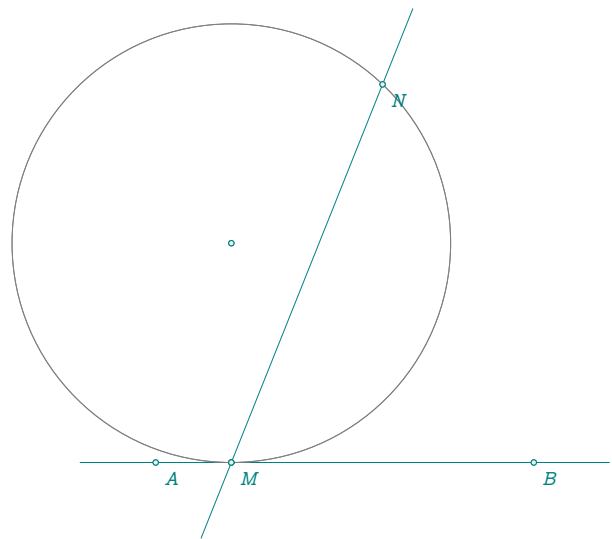

10.2.31 Method `c_ll_p`

Let's consider two straight lines (AB) and (AC) and a point P not belonging to these lines. Is there a circle through P tangent to these two lines?

The following example shows that there are two solutions using the method linked to the line. A more natural method, linked to the ABC triangle, can also be used.

```

\directlua{
init_elements()
z.A   = point : new ( 0 , 0 )
z.B   = point : new ( 6 , 0 )
L.AB  = line : new ( z.A,z.B )
z.C   = point : new ( 6 , 4 )
L.AC  = line : new ( z.A,z.C )
T     = triangle : new ( z.A,z.B,z.C )
z.P   = point : new ( 3 , 1 )
C1,C2 = L.AB : c_ll_p (z.C,z.P)
z.O1  = C1.center
z.T1  = C1.through
z.O2  = C2.center
z.T2  = C2.through
}
\begin{tikzpicture}[scale = .75]
\tkzGetNodes
\tkzDrawLines [thick] (A,B A,C)
\tkzDrawCircles [red] (O1,T1 O2,T2)
\tkzDrawPoints(A,B,C,P)
\tkzLabelPoints(A,B,C,P)
\end{tikzpicture}

```

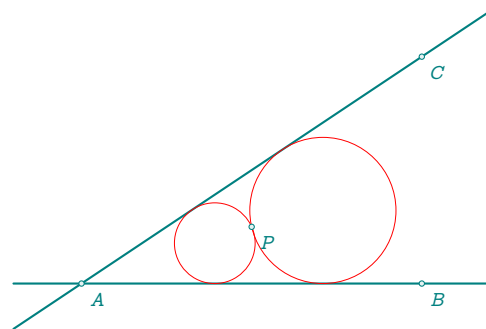

The first special case is where the point P lies on the bisector of A .

```

\directlua{
init_elements()
  z.A = point : new ( 0 , 0)
  z.B = point : new ( 6 , 0)
  L.AB = line : new ( z.A,z.B)
  z.C = point : new ( 6 , 4)
  L.AC = line : new ( z.A,z.C )
  T = triangle : new (z.A,z.B,z.C)
  L.bi = bisector(z.A,z.B,z.C)
  z.P = L.bi :point (0.4)
  C1,C2 = L.AB : c_ll_p (z.C,z.P)
  z.O1 = C1.center
  z.T1 = C1.through
  z.O2 = C2.center
  z.T2 = C2.through
}
\begin{tikzpicture}[scale = .75]
\tkzGetNodes
\tkzDrawLines(A,B A,C A,P)
\tkzDrawCircles(O1,T1 O2,T2)
\tkzDrawPoints(A,B,C,P)
\tkzLabelPoints(A,B,C,P)
\end{tikzpicture}

```

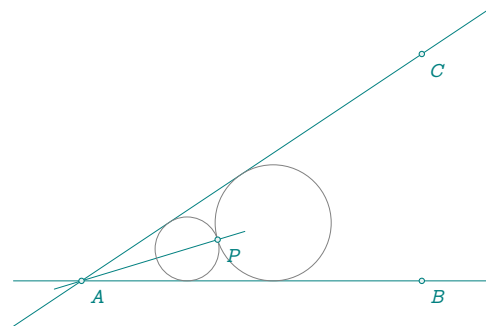

A first special case is when the point P lies on one of the lines

```

\directlua{
init_elements()
  z.A = point:new(0, 0)
  z.B = point:new(6, 0)
  L.AB = line:new(z.A,z.B)
  z.C = point:new(6, 4)
  L.AC = line:new(z.A,z.C)
  T = triangle:new(z.A,z.B,z.C)
  z.P = point:new(3, 2)
  L.bi = bisector(z.A,z.B,z.C)
  z.I = L.bi:point(0.4)
  C1,C2 = L.AB : c_ll_p (z.C,z.P)
  z.O1 = C1.center
  z.T1 = C1.through
  z.O2 = C2.center
  z.T2 = C2.through
}
\begin{tikzpicture}[scale = .75]
\tkzGetNodes
\tkzDrawLines(A,B A,C A,I)
\tkzDrawCircles(O1,T1 O2,T2)
\tkzDrawPoints(A,B,C,P,I)
\tkzLabelPoints(A,B,C,P,I)
\end{tikzpicture}

```

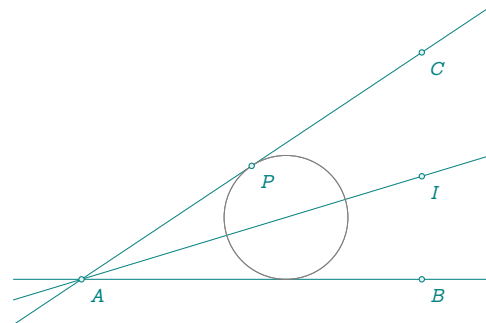

11 Class circle

11.1 Attributes of a circle

This class is defined by two points: the center and a point through which the circle passes

```
Creation C.OA = circle: new (z.O,z.A)
```

Table 7: Circle attributes.

Attributes	Application	
center	$z.A = C.AB.center$	
through	$z.B = C.AB.through$	
type	$C.AB.type$	$C.OA.type = 'circle'$
radius	$C.AB.radius$	$r = C.OA.radius$ r real number
north	$C.AB.north$	$z.N = C.OA.north$
south	$C.AB.south$	$z.S = C.OA.south$
east	$C.AB.east$	$z.E = C.OA.east$
west	$C.AB.west$	$z.W = C.OA.west$
opp	$z.Ap = C.AB.opp$	[11.1.1]
ct	$L = C.AB.ct$ [11.1.1]	
perimeter	$p = C.AB.perimeter$ [11.1.2]	
area	$a = C.AB.area$ [11.1.2]	

11.1.1 Example: circle attributes

Three attributes are used (south, west, radius).

```
\directlua{%
init_elements ()
  z.a = point: new (1, 1)
  z.b = point: new (5, 4)
  C.ab = circle : new (z.a,z.b)
  z.s = C.ab.south
  z.w = C.ab.west
  r = C.ab.radius
  z.c = C.ab.opp
  z.r,z.t = get_points (C.ab.ct : ortho_from (z.b))
}
\begin{tikzpicture}
\tkzGetNodes
\tkzDrawPoints(a,b,c,s,w)
\tkzLabelPoints(a,b,c,s,w)
\tkzDrawCircle(a,b)
\tkzDrawSegments(a,b r,t b,c)
\tkzLabelSegment[sloped] (a,b){ab = \tkzUseLua{r}}
\end{tikzpicture}
```

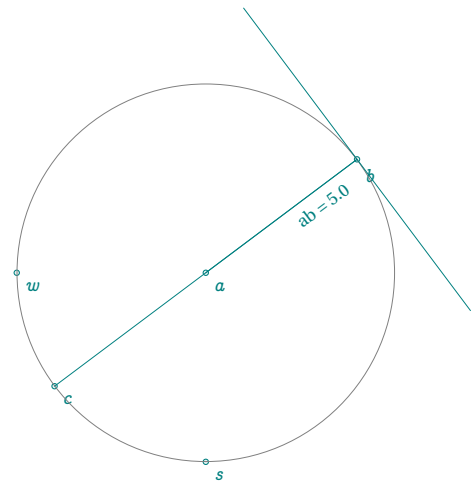

11.1.2 Attributes perimeter and area

```
\directlua{
z.A = point : new (1, 2)
z.B = point : new (4, 3)
C.AB = circle : new (z.A,z.B)
p = C.AB.perimeter
a = C.AB.area
}
```

Let be two points A and B . The circle of center A passing through B has perimeter $\text{\tkzUseLua{p}} \text{ cm}$ and area $\text{\tkzUseLua{a}} \text{ cm}^2$.

Let be two points A and B . The circle of center A passing through B has perimeter 19.8692 cm and area 125.6637 cm^2 .

11.2 Methods of the class circle

Table 8: Circle methods.

Methods	Comments	
<code>new(O,A)</code>	<code>C.OA = circle : new (z.O,z.A)</code>	center O through A ; [11.2.1]
<code>radius(O,r)</code>	<code>C.OA = circle : radius (z.O,2)</code>	center O radius =2 cm; [11.2.2]
<code>diameter(A,B)</code>	<code>C.OA = circle :diameter(z.A,z.B)</code>	diameter $[AB]$; [11.2.3]
Reals		
<code>power (pt)</code>	<code>r = C.OA: power (z.M)</code>	26.34]
Strings		
<code>circles_position (C1)</code>	<code>result = string</code>	[11.2.23]
Booleans		
<code>in_out (pt)</code>	<code>C.OA : in_out (z.M)</code>	[11.2.22]
<code>in_out_disk (pt)</code>	<code>C.OA : in_out_disk (z.M)</code>	[11.2.22]
<code>is_tangent (L)</code>	<code>C.OA : is_tangent (L.CD)</code>	[11.2.4]
Points		
<code>antipode (pt)</code>	<code>z.C = C.OA: antipode (z.B)</code>	$[BC]$ = diameter; [11.2.5]
<code>midarc (pt,pt)</code>	<code>z.D = C.AB: midarc (z.B,z.C)</code>	D is the midarc of \widehat{BC} ; [11.2.6]
<code>point (r)</code>	<code>z.E = C.AB: point (0.25)</code>	r between 0 and 1; [11.2.7]
<code>random_pt(lower, upper)</code>		
<code>inversion (obj)</code>	<code>z.Bp = C.AC: inversion (z.B)</code>	[11.2.8]
<code>internal_similitude (C)</code>	<code>z.I= C.one: internal_similitude(C.two)</code>	[11.2.9]
<code>external_similitude (C)</code>	<code>z.J= C.one: external_similitude(C.two)</code>	[11.2.10]
<code>radical_center (C1<,C2>)</code>	<code>or only (C1)</code>	[11.2.11]
Lines		
<code>radical_axis (C)</code>	[11.2.12 ; 26.4]	
<code>tangent_at (pt)</code>	<code>z.P=C.OA:tangent_at(z.M)</code>	[11.2.13]
<code>tangent_from (pt)</code>	<code>z.M,z.N=C.OA: tangent_from (z.P)</code>	[11.2.13]
<code>common_tangent (C)</code>	<code>z.a,z.b = C.AC: common_tangent (C.EF)</code>	[11.2.14 ; 26.8]
<code>polar()</code>	<code>L.polar=C.OA:polar ()</code>	[11.2.15]
Circles		
<code>orthogonal_from (pt)</code>	<code>C=C.OA:orthogonal_from (z.P)</code>	[11.2.16 ;26.5 ; 26.39]
<code>orthogonal_through(pta,ptb)</code>	<code>C=C.OA:orthogonal_through (z.z1,z.z2)</code>	[11.2.17]
<code>midcircle (C)</code>	<code>C.inv = C.OA: midcircle (C.EF)</code>	[11.2.18]
<code>radical_circle (C1<,C2>)</code>	<code>or only (C1)</code>	[11.2.19]
<code>c_c_pp(pt,pt)</code>	<code>C1,C2=C.A:c_cc_p (z.P,z.Q)</code>	[11.2.24]
<code>c_cc_p(C,pt)</code>	<code>C1,C2=C.A:c_cc_p (C.B,z.P)</code>	[11.2.25]
<code>c_lc_p(L,pt,<inside>)</code>	<code>C1,C2=C.A:c_cc_p (L.AB,z.P)</code>	[11.2.26]

11.2.1 Method new

A circle is defined by its centre and a point through which it passes.

```

\directlua{%
init_elements ()
z.O    = point:    new (0,0)
z.A    = point:    new (2,1)
C      = circle:   new (z.O , z.A)
}
\begin{tikzpicture}[gridded]
\tkzGetNodes
\tkzDrawCircles(O,A)
\tkzDrawPoints(A,O)
\tkzLabelPoints[right](A,O)
\end{tikzpicture}

```

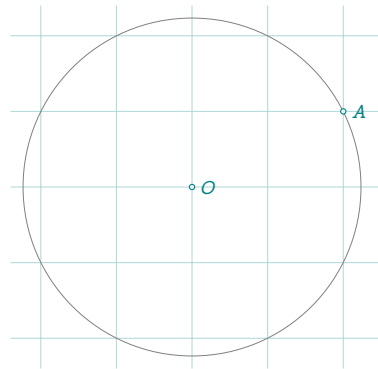

11.2.2 Method radius

We define a circle with its centre and radius.

```

\directlua{%
init_elements ()
z.O    = point:    new (0,0)
z.A    = point:    new (2,1)
C      = circle:   radius (z.A , math.sqrt(5))
z.T    = C.through
}
\begin{tikzpicture}[gridded]
\tkzGetNodes
\tkzDrawCircles(A,T)
\tkzDrawPoints(A,O,T)
\tkzLabelPoints[right](A,O,T)
\end{tikzpicture}

```

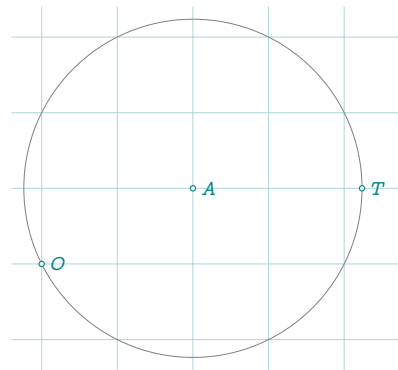

11.2.3 Method diameter

A circle is defined by two points at the ends of one of its diameters.

```

\directlua{%
init_elements ()
z.A    = point:    new (0,0)
z.B    = point:    new (2,1)
C      = circle:   diameter (z.A , z.B)
z.O    = C.center
z.T    = C.through
}
\begin{tikzpicture}[gridded]
\tkzGetNodes
\tkzDrawCircles(O,T)
\tkzDrawPoints(A,B,O,T)
\tkzLabelPoints[right](A,B,O,T)
\end{tikzpicture}

```

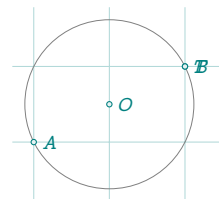

11.2.4 Method `is_tangent`

```

\directlua{
z.A = point: new (0,0)
z.B = point: new (0,2)
C.AB = circle: new (z.A,z.B)
z.C = point: new (2,-2)
z.D = point: new (2,3)
L.CD = line : new (z.C,z.D)
if C.AB : is_tangent (L.CD)
then tex.print("L.CD tangent to C.AB")
else
tex.print("L.CD no tangent to C.AB")
end
}
\begin{tikzpicture}
\tkzGetNodes
\tkzDrawCircle(A,B)
\tkzDrawLines(C,D)
\tkzDrawPoints(A,...,D)
\tkzLabelPoints[below left](A,C)
\tkzLabelPoints[above right](B,D)
\end{tikzpicture}

```

L.CD tangent to C.AB

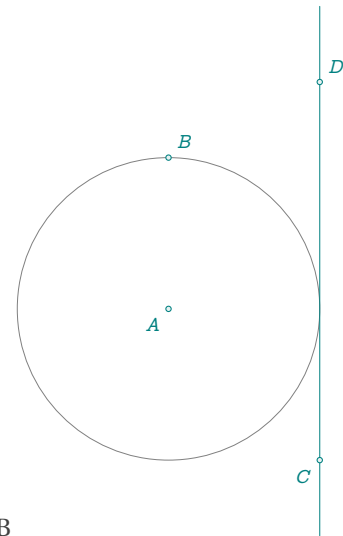
11.2.5 Method `antipode`

This method is used to define a point that is diametrically opposed to a point on a given circle.

```

\directlua{%
init_elements ()
z.A = point: new (0,0)
z.O = point: new (2,1)
C = circle: new (z.O , z.A)
z.B = C : antipode (z.A)
}
\begin{tikzpicture}[gridded]
\tkzGetNodes
\tkzDrawCircles(O,A)
\tkzDrawPoints(A,B,O)
\tkzLabelPoints[right](A,B,O)
\end{tikzpicture}

```

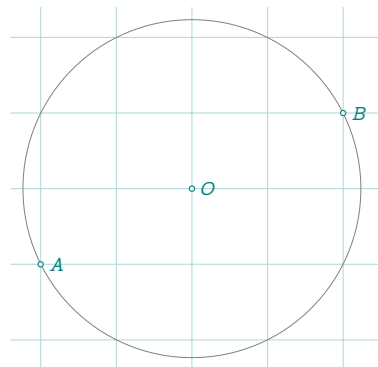
11.2.6 Method `midarc`

The definition given in [[Weisstein, Eric W. "Mid-Arc Points." From MathWorld—A Wolfram Web Resource.](#)] is as follows: The mid-arc points of a triangle as defined by Johnson (1929) are the points on the circumcircle of the triangle which lie half-way along each of the three arcs determined by the vertices. These points arise in the definition of the Fuhrmann circle and Fuhrmann triangle, and lie on the extensions of the perpendicular bisectors of the triangle sides drawn from the circumcenter.

The definition I use here is more general: the defined point is simply the point that divides an arc into two arcs of the same length.

```

\directlua{%
init_elements ()
z.A = point: new (0,0)
z.O = point: new (2,1)
C = circle: new (z.O , z.A)
z.B = C : point (0.25)
z.M = C : midarc (z.A,z.B)
}
\begin{tikzpicture}[gridded]
\tkzGetNodes
\tkzDrawCircles(O,A)
\tkzDrawPoints(A,B,O,M)
\tkzLabelPoints[right](A,B,O,M)
\end{tikzpicture}

```

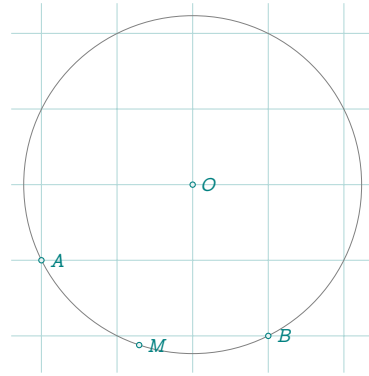

11.2.7 Method point (r)

Let C be a circle with centre O and passing through A such that $z.A = C$. This method defines a point M on the circle from A such that the ratio of the length of \widehat{AM} to the circumference of the circle is equal to r .

In the next example, $r = \frac{1}{6}$ corresponds to $\frac{\pi/3}{2\pi}$, so the angle \widehat{AOE} has the measure $\pi/3$.

If $r = .5$ the defined point is diametrically opposed to A , the angle \widehat{AOD} has the measure π .

```

\directlua{%
init_elements ()
z.O = point: new (0,0)
z.A = point: new (1,2)
C.OA = circle: new (z.O,z.A)
z.B = C.OA: point (1/6)
z.C = C.OA: point (0.25)
z.D = C.OA: point (0.5)
}
\begin{tikzpicture}
\tkzGetNodes
\tkzDrawCircle(O,A)
\tkzDrawPoints(A,...,D,O)
\tkzLabelPoints(A,...,D,O)
\end{tikzpicture}

```

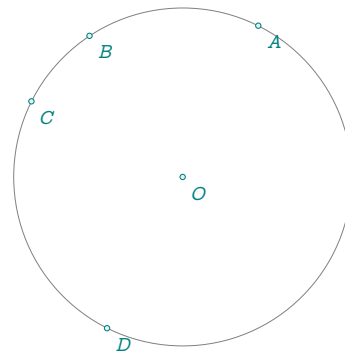

11.2.8 Method inversion (obj): point, line and circle

The inversion method can be used on a point, a line or a circle. Depending on the type of object, the function determines the correct algorithm to use.

Inversion: point The inversion method can be used on a point, a group of points, a line or a circle. Depending on the type of object, the function determines the correct algorithm to use.

```

\directlua{%
init_elements ()
  z.o = point:   new (-1,2)
  z.a = point:   new (2,1)
  C.oa = circle: new (z.o,z.a)
  z.c = point:   new (3,4)
  z.d = C.oa:    inversion (z.c)
  p    = C.oa:   power (z.c)
}
\begin{tikzpicture}[scale =.75]
  \tkzGetNodes
  \tkzDrawCircle(o,a)
  \tkzDrawSegments(o,a o,c)
  \tkzDrawPoints(a,o,c,d)
  \tkzLabelPoints(a,o,c,d)
  \tkzLabelSegment[sloped,above=1em](c,d){%
    Power of c with respect to C is \tkzUseLua{p}}
\end{tikzpicture}

```

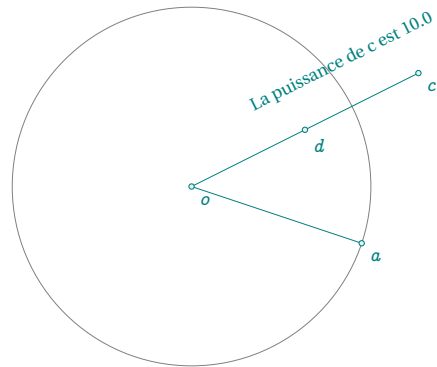

Inversion: line The result is either a straight line or a circle.

```

\directlua{%
init_elements ()
  z.o = point:   new (-1,1)
  z.a = point:   new (1,3)
  C.oa = circle: new (z.o,z.a)
  z.c = point:   new (3,2)
  z.d = point:   new (0,4)
  L.cd = line:    new (z.c,z.d)
  C.OH = C.oa:   inversion (L.cd)
  z.O,z.H = get_points(C.OH)
}
\begin{tikzpicture}
  \tkzGetNodes
  \tkzDrawCircles(o,a O,H)
  \tkzDrawLines(c,d o,H)
  \tkzDrawPoints(a,o,c,d,H)
  \tkzLabelPoints(a,o,c,d,H)
\end{tikzpicture}

```

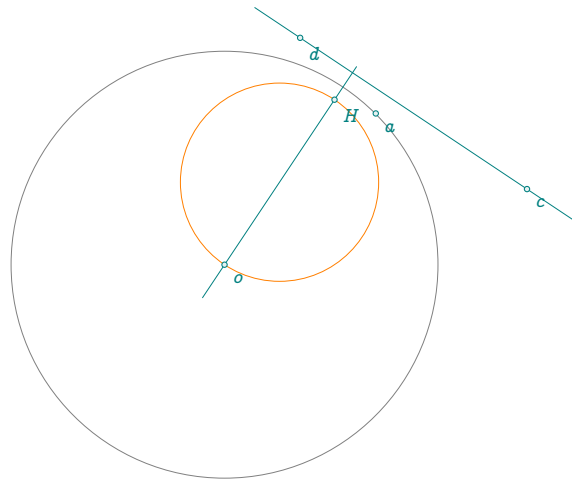

Inversion: circle The result is either a straight line or a circle.

```

\directlua{%
init_elements ()
z.o = point: new (-1,3)
z.a = point: new (2,3)
z.c = point: new (-2,1)
z.e, = point: new (-2,7)
z.d = point: new (-3,5)
C.oa = circle: new (z.o,z.a)
C.ed = circle: new (z.e,z.d)
C.co = circle: new (z.c,z.o)
obj = C.oa: inversion (C.co)
if obj.type == "line"
then z.p,z.q = get_points(obj)
else z.f,z.b = get_points(obj) end
obj = C.oa: inversion(C.ed)
if obj.type == "line"
then z.p,z.q = get_points(obj)
else z.f,z.b = get_points(obj) end
color = "orange"
}
\begin{tikzpicture}[scale = .75]
\tkzGetNodes
\tkzDrawCircles[black](o,a)
\tkzDrawCircles[teal](c,o e,d)
\tkzDrawCircles[\tkzUseLua{color}](f,b)
\tkzDrawSegments[\tkzUseLua{color}](p,q)
\tkzDrawPoints(a,...,f,o,p,q)
\tkzLabelPoints(a,...,f,o,p,q)
\end{tikzpicture}

```

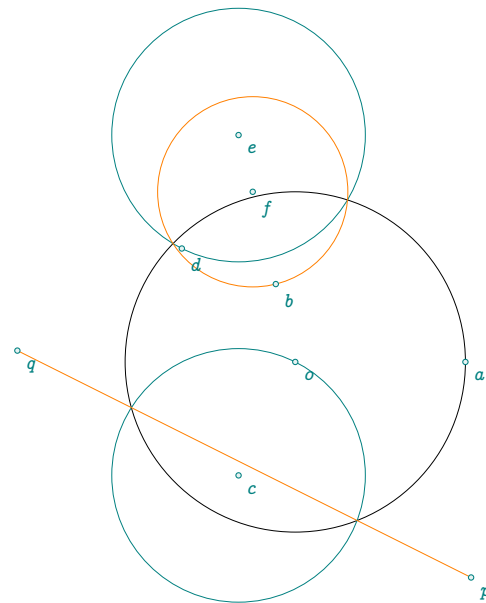

11.2.9 Method `internal_similitude`

Circles are geometrically similar to one another and mirror symmetric. Hence, a pair of circles has both types of homothetic centers, internal and external, unless the centers are equal or the radii are equal; these exceptional cases are treated after general position. These two homothetic centers lie on the line joining the centers of the two given circles, which is called the line of centers. Circles with radius zero can also be included (see exceptional cases), and negative radius can also be used, switching external and internal. [Wikipedia]

```

\directlua{%
init_elements ()
z.A = point : new ( 0 , 0 )
z.a = point : new ( 2 , 2 )
z.B = point : new ( 5 , 2 )
z.b = point : new ( 6 , 1 )
C.Aa = circle : new (z.A,z.a)
C.Bb = circle : new (z.B,z.b)
z.I = C.Aa : internal_similitude (C.Bb)
L.TA1,L.TA2 = C.Aa : tangent_from (z.I)
z.A1 = L.TA1.pb
z.A2 = L.TA2.pb
}
\begin{tikzpicture}
\tkzGetNodes
\tkzDrawCircles(A,a B,b)
\tkzDrawPoints(A,a,B,b,I,A1,A2)
\tkzDrawLines[add = 1 and 2](A1,I A2,I)
\end{tikzpicture}

```

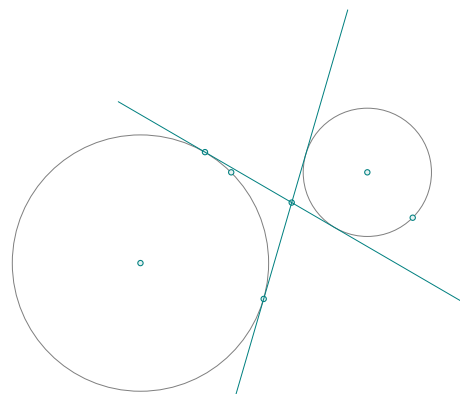

11.2.10 Method `external_similitude`

```

\directlua{%
init_elements ()
z.A = point : new ( 0 , 0 )
z.a = point : new ( 2 , 2 )
z.B = point : new ( 3 , 2 )
z.b = point : new ( 3.5 , 1 )
C.Aa = circle : new (z.A,z.a)
C.Bb = circle : new (z.B,z.b)
z.I = C.Aa : external_similitude (C.Bb)
L.TA1,L.TA2 = C.Aa : tangent_from (z.I)
z.A1 = L.TA1.pb
z.A2 = L.TA2.pb
}
\begin{tikzpicture}[scale = .75]
\tkzGetNodes
\tkzDrawCircles(A,a B,b)
\tkzDrawPoints(A,a,B,b,I,A1,A2)
\tkzDrawLines[add = .25 and .1](A1,I A2,I)
\end{tikzpicture}

```

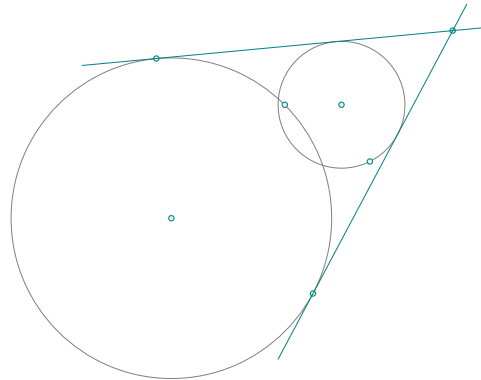

11.2.11 Method `radical_center` (C1,C2)

The radical lines of three circles are concurrent in a point known as the radical center (also called the power center). This theorem was originally demonstrated by Monge (Dörrie 1965, p. 153). [Weisstein, Eric W. "Radical Center." From MathWorld—A Wolfram Web Resource.]

Here I have also named `radical_center` the point of intersection of the radical axis of two circles with the centre axis. See the following example for how to obtain point H .

```
\directlua{%
init_elements ()
  z.0      = point : new (0,0)
  z.x      = point : new (1,0)
  z.y      = point : new (4,0)
  z.z      = point : new (2,0)
  z.0p     = point : new (4,2)
  z.P      = point : new (2,2.5)
  C.0x     = circle :   new (z.0,z.x)
  C.Pz     = circle :   new (z.P,z.z)
  C.0py    = circle :   new (z.0p,z.y)
  z.ap,z.a = intersection (C.0x,C.Pz)
  z.bp,z.b = intersection (C.0py,C.Pz)
  L.aap    = line : new (z.a,z.ap)
  L.bbp    = line : new (z.b,z.bp)
  % z.X     = intersection (L.aap,L.bbp)
  z.X      = C.0x : radical_center(C.Pz,C.0py)
  % L.00p   = line : new (z.0,z.0p)
  % z.H     = L.00p : projection (z.X)
  z.H = C.0x : radical_center(C.0py)
}
\begin{tikzpicture}[scale = .75]
  \tkzGetNodes
  \tkzDrawCircles(0,a 0',b P,z)
  \tkzDrawLines[red](a,X b',X H,X 0,0')
  \tkzDrawPoints(0,0',P,a,a',b,b',X,H)
  \tkzLabelPoints[below right](0,0',P,H)
\end{tikzpicture}
```

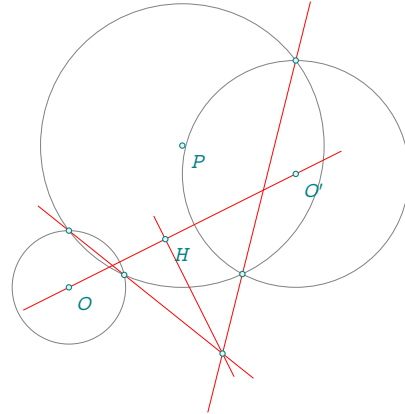

11.2.12 Method radical_axis(C)

The radical line, also called the radical axis, is the locus of points of equal circle power with respect to two non-concentric circles. By the chordal theorem, it is perpendicular to the line of centers (Dörrie 1965).

[Weisstein, Eric W. "Radical Line." From MathWorld—A Wolfram Web Resource.]

Radical axis v1

```
\directlua{%
init_elements ()
z.X    = point: new (0,0)
z.B    = point: new (2,2)
z.Y    = point: new (7,1)
z.Ap   = point: new (8,-1)
L.XY   = line :   new (z.X,z.Y)
C.XB   = circle : new (z.X,z.B)
C.YAp  = circle : new (z.Y,z.Ap)
z.E,z.F= get_points(C.XB:radical_axis(C.YAp))
z.A    = C.XB : point (0.4)
T.ABAp = triangle: new (z.A,z.B,z.Ap)
z.O    = T.ABAp.circumcenter
C.OAp  = circle : new (z.O,z.Ap)
_,z.Bp = intersection (C.OAp,C.YAp)
L.AB   = line : new (z.A,z.B)
L.ApBp = line : new (z.Ap,z.Bp)
z.M    = intersection (L.AB,L.ApBp)
z.H    = L.XY : projection (z.M)
}
```

```
\begin{tikzpicture}[scale = .75]
\tkzGetNodes
\tkzDrawCircles(X,B Y,A')
\tkzDrawArc[dashed,delta=30](O,A')(A)
\tkzDrawPoints(A,B,A',B',M,H,X,Y,O,E,F)
\tkzDrawLines[red](A,M A',M X,Y E,F)
\tkzDrawLines[red,add=1 and 3](M,H)
\end{tikzpicture}
```

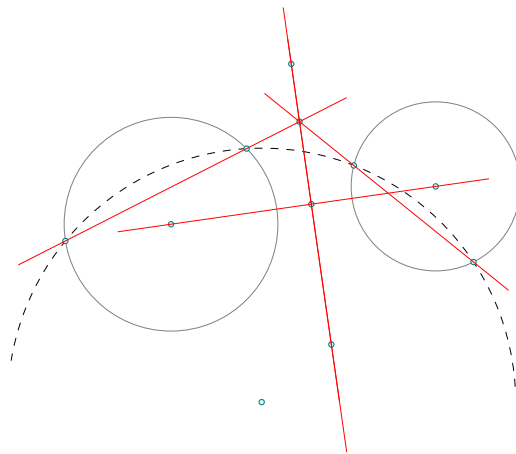

Radical axis v2

```
\directlua{%
init_elements ()
z.O    = point : new (-1,0)
z.Op   = point : new (4,-1)
z.B    = point : new (0,2)
z.D    = point : new (4,0)
C.OB   = circle :   new (z.O,z.B)
C.OpD  = circle :   new (z.Op,z.D)
L.EF   = C.OB : radical_axis (C.OpD)
z.E,z.F = get_points (L.EF)
z.M    = L.EF : point (.75)
L.MT,L.MTp = C.OB : tangent_from (z.M)
_,z.T   = get_points (L.MT)
_,z.Tp  = get_points (L.MTp)
L.MK,L.MKp = C.OpD : tangent_from (z.M)
_,z.K   = get_points (L.MK)
_,z.Kp  = get_points (L.MKp)
}
```

```
\begin{tikzpicture}[scale = .5]
\tkzGetNodes
\tkzDrawCircles(O,B O',D)
\tkzDrawLine(E,F)
\tkzDrawLine[add=.25 and .25](O,O')
\tkzDrawLines[add = 0 and .5](M,T M,T'
M,K M,K')
\tkzDrawCircle(M,T)
\tkzDrawPoints(O,O',T,M,T',K,K')
\tkzLabelPoints(O,O',T,T',K,K',M)
\end{tikzpicture}
```

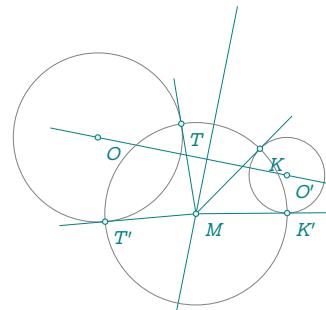

Radical axis v3

```

\directlua{%
init_elements ()
z.O      = point : new (0,0)
z.B      = point : new (4,0)
z.Op     = point : new (6,0)
C.OB     = circle :   new (z.O,z.B)
C.OpB    = circle :   new (z.Op,z.B)
L.EF     = C.OB : radical_axis (C.OpB)
z.E,z.F  = get_points(L.EF)
z.M      = L.EF : point (0.2)
L        = C.OB : tangent_from (z.M)
_,z.T    = get_points (L)
L        = C.OpB : tangent_from (z.M)
_,z.Tp   = get_points (L)
}

```

Radical axis v4

```

\directlua{%
init_elements ()
z.O      = point : new (0,0)
z.B      = point : new (5,0)
z.Op     = point : new (3,0)
C.OB     = circle :   new (z.O,z.B)
C.OpB    = circle :   new (z.Op,z.B)
L.EF     = C.OB : radical_axis (C.OpB)
z.E,z.F  = get_points(L.EF)
z.H      = L.EF.mid
z.M      = L.EF : point (.8)
_,L      = C.OB : tangent_from (z.M)
_,z.T    = get_points (L)
_,L      = C.OpB : tangent_from (z.M)
_,z.Tp   = get_points (L)}

```

```

\begin{tikzpicture}[scale =.5]
\tkzGetNodes
\tkzDrawCircles(O,B O',B)
\tkzDrawSegments(M,T M,T')
\tkzDrawSegments(E,F)
\tkzDrawLine[add=.5 and .5](O,0')
\tkzDrawPoints(O,B,O',E,F,M,T,T')
\tkzLabelPoints(O,0',B,E,F,T,T')
\tkzDrawArc(M,T')(T)
\end{tikzpicture}

```

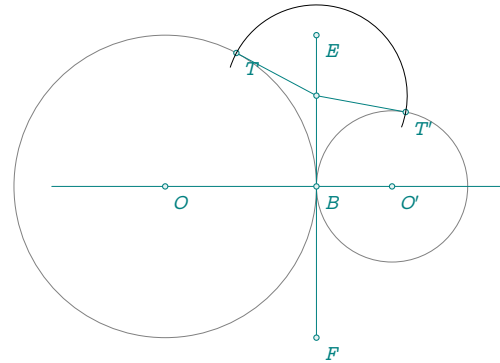

```

\begin{tikzpicture}[scale =.5]
\tkzGetNodes
\tkzDrawCircles(O,B O',B)
\tkzDrawSegments(M,T M,T')
\tkzDrawSegments(E,F)
\tkzDrawLine[add=.3 and .3](O,H)
\tkzDrawPoints(O,0',B,E,H,M)
\tkzLabelPoints[below right](O,0',E,F,M,T,T')
\tkzDrawArc(M,B)(T)
\end{tikzpicture}

```

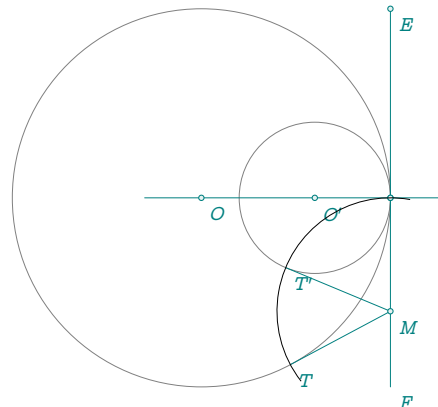

11.2.13 Methods `tangent_at (P)` and `tangent_from (P)`

```

\directlua{%
init_elements ()
  z.A = point: new (0,0)
  z.B = point: new (1,2)
  C.AB = circle: new (z.A,z.B)
  z.C = point: new (3,-2)
  L.T = C.AB : tangent_at (z.B)
  z.D = L.T.pb
  L.T1,L.T2 = C.AB : tangent_from (z.C)
  z.T1 = L.T1.pb
  z.T2 = L.T2.pb
}
\begin{tikzpicture}
\tkzGetNodes
\tkzDrawCircle(A,B)
\tkzDrawLines[add =.5 and .5](B,D C,T1 C,T2)
\tkzDrawSegments[dashed](A,B A,T1 A,T2)
\tkzDrawPoints(A,...,D,T1,T2)
\tkzLabelPoints[below left](A,T2,C)
\tkzLabelPoints[above right](B,T1,D)
\tkzMarkRightAngles(A,B,D A,T1,C A,T2,C)
\end{tikzpicture}

```

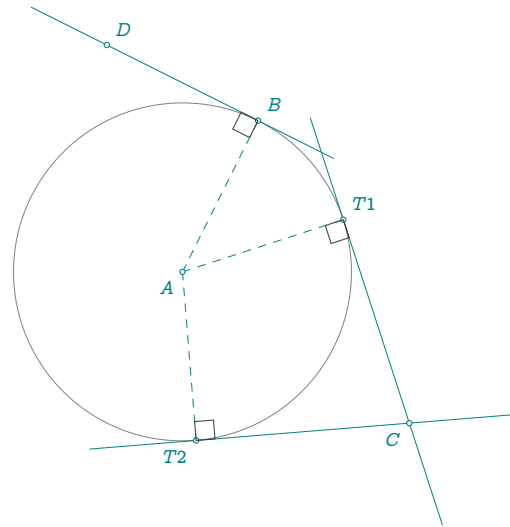
11.2.14 Methode `commun_tangent`: Angle of two intersecting circles

Let be a tangent common to both circles at T and T' (closest to C). Let a secant parallel to this tangent pass through C . Then the segment $[TT']$ is seen from the other common point D at an angle equal to half the angle of the two circles.

```

\directlua{%
init_elements ()
  z.A = point : new ( 0, 0)
  z.B = point : new ( 5, 2)
  L.AB = line : new ( z.A, z.B)
  z.C = point : new ( 1, 2)
  C.AC = circle : new (z.A,z.C)
  C.BC = circle : new (z.B,z.C)
  z.T,z.Tp = C.AC : common_tangent(C.BC)
  L.TTp = line : new (z.T,z.Tp)
  z.M = C.AC : point (0.45)
  L.MC =line : new (z.M,z.C)
  z.Mp = intersection (L.MC, C.BC)
  L.mm = L.TTp : ll_from (z.C)
  _,z.M = intersection (L.mm, C.AC)
  z.Mp = intersection (L.mm, C.BC)
  _,z.D = intersection (C.AC,C.BC)
}
\begin{tikzpicture}
\tkzGetNodes
\tkzDrawCircles(A,C B,C)
\tkzDrawSegments(M,M' A,D B,D A,B C,D T,C T',C)
\tkzDrawSegments[gray](D,M D,M' T,T' D,T D,T')
\tkzDrawPoints(A,B,C,D,M,M',T,T')
\tkzLabelPoints(A,B,D,M)
\tkzLabelPoints[above](C,M',T,T')

```

```

\tkzMarkAngles[mark=|,size=.75](T,C,M C,T,T' C,D,T T,D,M)
\tkzMarkAngles[mark=||,size=.75](M',C,T' T,T',C T',D,C M',D,T')
\end{tikzpicture}

```

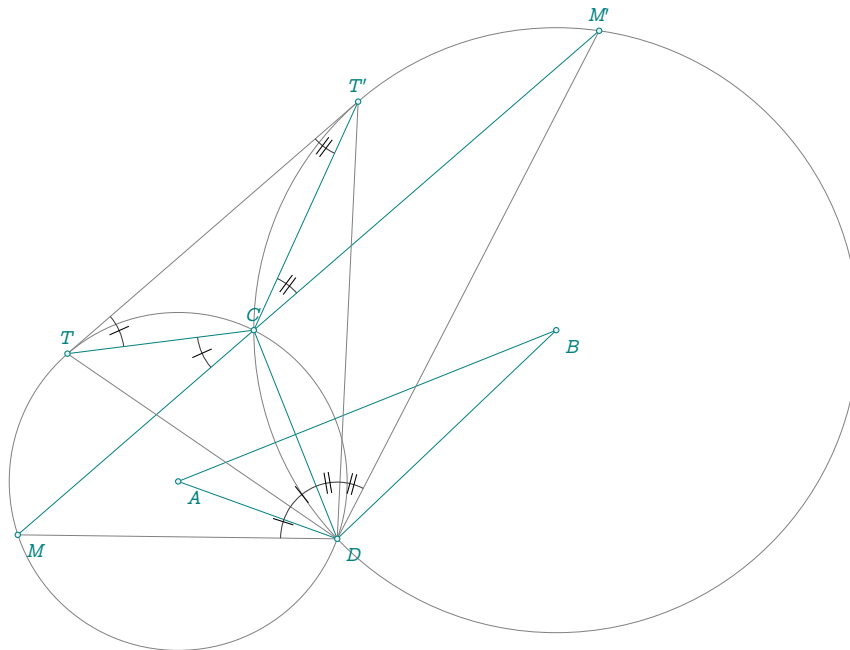

11.2.15 Method `polar(pt)`

In geometry, a pole and polar are respectively a point and a line that have a unique reciprocal relationship with respect to a given conic section.

Polar reciprocation in a given circle is the transformation of each point in the plane into its polar line and each line in the plane into its pole.[Wikipedia]

This method currently only applies to the circle.

The pole of a line L in a circle C is a point Q that is the inversion in C of the point P on L that is closest to the center of the circle. Conversely, the polar line (or polar) of a point Q in a circle C is the line L such that its closest point P to the center of the circle is the inversion of Q in C .

```

\directlua{
  z.o      = point:   new (-1,1)
  z.t      = point:   new (1,3)
  z.P      = point:   new (3.2,0)
  C.o      = circle:  new (z.o,z.t)
  L.P      = C.o: polar (z.P)
  z.a,z.b  = get_points(L.P)
  z.u,z.v  = intersection (C.o,L.P)
  z.K      = L.P: projection (z.P)
  L.K      = C.o: polar (z.K)
  z.ka,z.kb = get_points(L.K)
  C.wH     = C.o: inversion (L.P)
  z.w,z.H  = get_points(C.wH)
  z.ap,z.bp = C.o: inversion (z.a,z.b)
  L.oa     = line : new (z.o,z.a)
  z.cp     = intersection(L.K,L.oa)
  z.c      = C.o: inversion (z.cp)}
\begin{tikzpicture}
  \tkzGetNodes
  \tkzDrawCircles[red,thick](o,t)

```



```

\tkzDrawCircles(w,H)
\tkzDrawLines[red](P,u P,v)
\tkzDrawLines[blue,thick](u,v)
\tkzDrawLines[add = 1 and 1,green!50!black,thick](ka,kb)
\tkzDrawSegments[dashed](o,P o,c' o,b' K,c)
\tkzMarkRightAngle[size=.1,fill=lightgray!15](o,c,K)
\tkzDrawPoints(o,w,K,P,a,b,u,v,a',b',c',c)
\tkzLabelPoints(o,w,b')
\tkzLabelPoints[above right,blue](a,b,u,v)
\tkzLabelPoints[above](c,a',c')
\tkzLabelPoints[right,blue](P)
\tkzLabelPoints[green!50!black,left](K)
\end{tikzpicture}

```

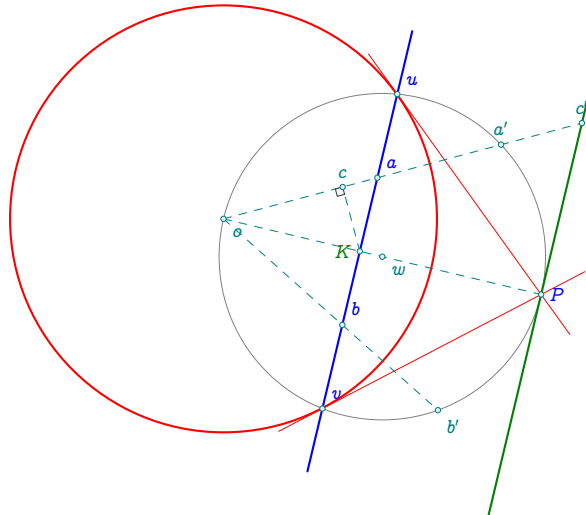

11.2.16 Method `orthogonal_from` (pt)

In geometry, two circles are said to be orthogonal if their respective tangent lines at the points of intersection are perpendicular (meet at a right angle). [wikipedia]

This method determines a circle with a given centre, orthogonal to a circle that is also given.

```

\directlua{%
init_elements ()
  z.C_1 = point: new (0,0)
  z.C_2 = point: new (8,0)
  z.A   = point: new (5,0)
  C     = circle: new (z.C_1,z.A)
  z.S,z.T = get_points (C: orthogonal_from (z.C_2))
}
\begin{tikzpicture}[ scale = .6]
\tkzGetNodes
\tkzDrawCircles(C_1,T C_2,T)
\tkzDrawSegments(C_1,T C_2,T)
\tkzDrawLine(C_1,C_2)
\tkzMarkRightAngle[fill=teal,%
opacity=.2,size=1](C_1,T,C_2)
\tkzDrawPoints(C_1,C_2,T)
\tkzLabelPoints(C_1,C_2)
\tkzLabelPoints[above](T)
\tkzLabelSegment[left](C_1,T){r}

```

```

\tkzLabelSegments[right](C_2,T){\gamma}
\tkzLabelSegment[below](C_1,C_2){d}
\tkzLabelCircle[left=10pt](C_1,T)(180){Circle 1}
\tkzLabelCircle[right=10pt](C_2,T)(180){Circle 2}
\end{tikzpicture}

```

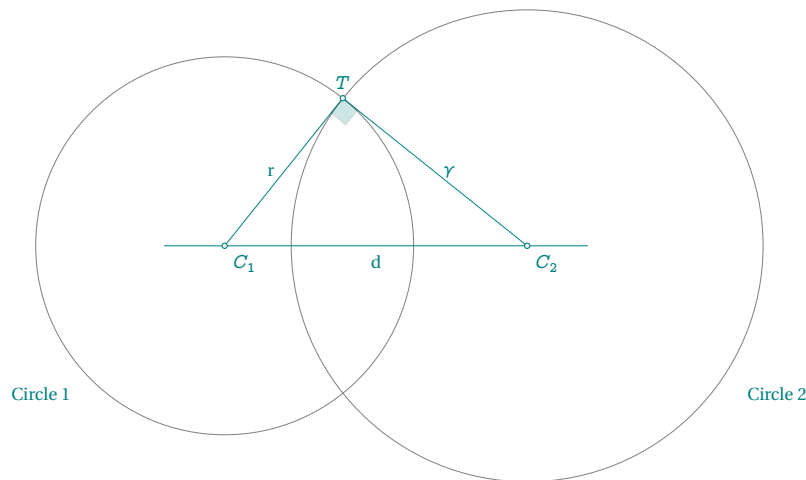

11.2.17 Method `orthogonal_through`

```

\directlua{%
init_elements ()
z.O = point: new (0,1)
z.A = point: new (1,0)
z.z1 = point: new (-1.5,-1.5)
z.z2 = point: new (2.5,-1.25)
C.OA = circle: new (z.O,z.A)
C = C.OA: orthogonal_through(z.z1,z.z2)
z.c = C.center
}
\begin{tikzpicture}
\tkzGetNodes
\tkzDrawCircle(O,A)
\tkzDrawCircle[new](c,z1)
\tkzDrawPoints[new](O,A,z1,z2,c)
\tkzLabelPoints[right](O,A)
\tkzLabelPoints[left](z1,z2,c)
\end{tikzpicture}

```

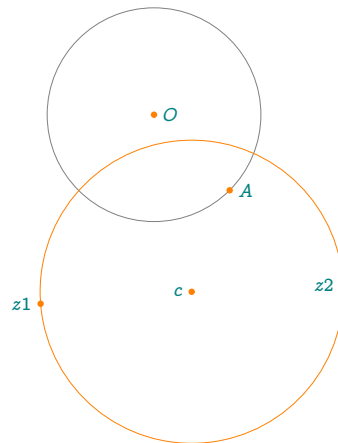

11.2.18 Method `mmidcircle`

From Eric Danneels and Floor van Lamoen: A midcircle of two given circles is a circle that swaps the two given circles by inversion. Midcircles are in the same pencil of circles as the given circles. The center of the midcircle(s) is one or both of the centers of similitude. We can distinguish four cases:

- (i) The two given circles intersect: there are two midcircles with centers at the centers of similitude of the given circles;
- (ii) One given circle is in the interior of the other given circle. Then there is one midcircle with center of similitude at the internal center of similitude of the given circles;
- (iii) One given circle is in the exterior of the other given circle. Then there is one midcircle with center at the external center of similitude of the given circles. Clearly the tangency cases can be seen as limit cases of the above;

- (iv) If the circles intersect in a single point, the unique midcircle has center at the external similitude center or at internal similitude center.

Let's look at each of these cases:

- (i) If the two given circles intersect, then there are two circles of inversion through their common points, with centers at the centers of similitudes. The two midcircles bisect their angles and are orthogonal to each other. The centers of the midcircles are the internal center of similitude and the external center of similitude I and J .

Consider two intersecting circles (A) and (B) . We can obtain the centers of similarity of these two circles by constructing EH and FG two diameters parallel of the circles (A) and (B) . The line (GE) intercepts the line (AB) in J and the line (EF) intercepts the line (AB) in I . The circles (I) and (J) are orthogonal and are the midcircles of (A) and (B) . The division $(A, B; I, J)$ is harmonic.

```
\directlua{%
init_elements ()
z.A = point : new ( 1 , 0 )
z.B = point : new ( 3 , 0 )
z.O = point : new ( 2.1 , 0 )
z.P = point : new ( 1 , 0 )
C.AO = circle : new (z.A,z.O)
C.BP = circle : new (z.B,z.P)
z.E = C.AO.south
z.H = C.AO.north
z.F = C.BP.north
z.G = C.BP.south
C.IT,C.JV = C.AO : midcircle (C.BP)
z.I,z.T = get_points (C.IT)
z.J,z.V = get_points (C.JV)
z.X,z.Y = intersection (C.AO,C.BP)
}
```

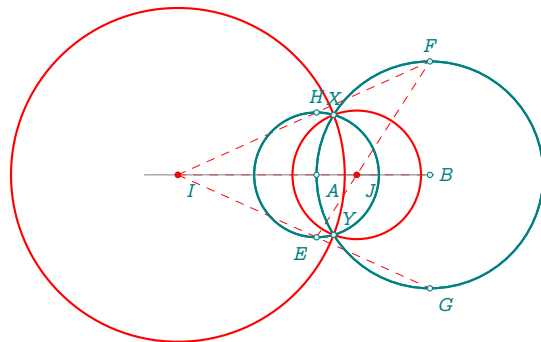

- (ii) One given circle is in the interior of the other given circle.

```
\directlua{%
init_elements ()
z.A = point : new ( 3 , 0 )
z.B = point : new ( 5 , 0 )
z.O = point : new ( 2 , 0 )
z.P = point : new ( 1 , 0 )
L.AB = line : new (z.A,z.B)
C.AO = circle : new (z.A,z.O)
C.BP = circle : new (z.B,z.P)
z.R,z.S = intersection (L.AB,C.BP)
z.U,z.V = intersection (L.AB,C.AO)
C.SV = circle: diameter (z.S,z.V)
C.UR = circle: diameter (z.U,z.R)
z.x = C.SV.center
z.y = C.UR.center
C.IT = C.AO : midcircle (C.BP)
z.I,z.T = get_points (C.IT)
}
```

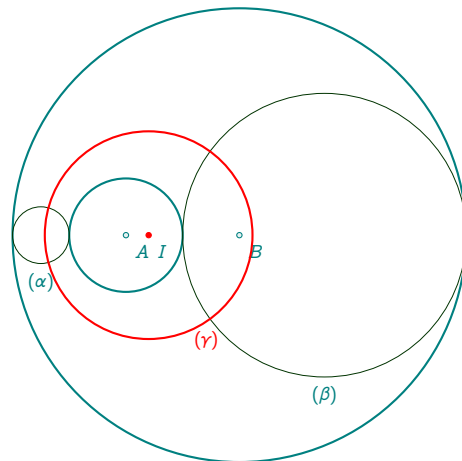

This case is a little more complicated. We'll construct the two circles (α) and (β) tangent to the two given circles. Then we construct the radical circle orthogonal to the circles (α) and (β) . Its center is the radical center as well as the center of internal similitude of circles of center A and B .

- (iii) When the two given circles are external to each other, we construct the external center of similitude of the two given circles. I is the center of external similarity of the two given circles. To obtain the inversion circle, simply note that H is such that $IH^2 = IE \times IF$.

```

\directlua{%
init_elements ()
z.A = point: new ( 0 , 0)
z.B = point: new ( 4 , 0)
z.a = point: new (.5 , 0)
z.b = point: new ( 1 , 0)
C.Aa = circle: new (z.A,z.a)
C.Bb = circle: new (z.B,z.b)
L.AB = line: new (z.A,z.B)
z.E = C.Aa.north
z.F = C.Bb.north
L.EF = line: new (z.E,z.F)
C.IT = C.Aa: midcircle (C.Bb)
z.I,z.T = get_points (C.IT)
L.TF = C.Bb: tangent_from (z.I)
z.H = intersection (L.TF,C.IT)
z.E = intersection (L.TF,C.Aa)
z.F = L.TF.pb
}
\begin{tikzpicture}[scale=.6]
\tkzGetNodes
\tkzDrawCircles[teal,thick](A,a B,b)
\tkzDrawCircles[red,thick](I,T)
\tkzDrawSegments[gray](I,F)
\tkzDrawPoints(A,B,E,F)
\tkzDrawPoints[red](I,H)
\tkzDrawLine(I,B)
\tkzLabelPoints(A,B)
\tkzLabelPoints[above](E,F)
\tkzLabelPoints[above left,red](I)
\tkzLabelPoints[above right,red](H)
\end{tikzpicture}

```

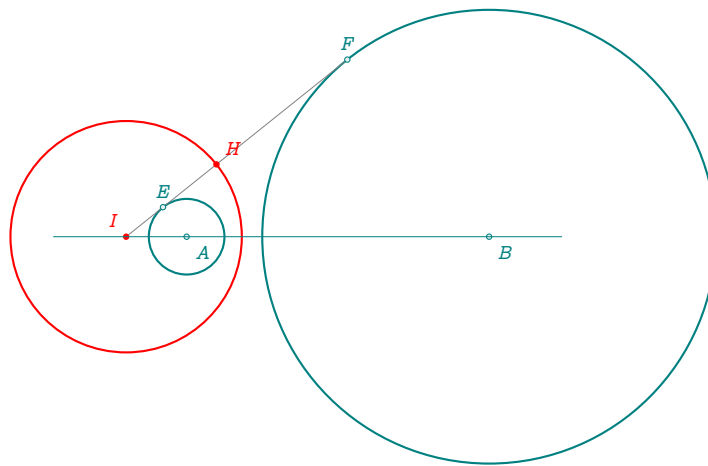

- (iv) Consider two tangent circles (\mathcal{A}) and (\mathcal{B}),
 – (\mathcal{B}) being external and angent to (\mathcal{A}). The construction is identical to the previous one.

```

\directlua{%
init_elements ()
local a,b,c,d
z.A = point : new ( 0 , 0 )
z.B = point : new ( 4 , 0 )
z.a = point : new ( 1 , 0 )
z.b = point : new ( 1 , 0 )
C.Aa = circle : new (z.A,z.a)
C.Bb = circle : new (z.B,z.b)
L.AB = line : new (z.A,z.B)
z.E = C.Aa.north
z.F = C.Bb.north
L.EF = line : new (z.E,z.F)
C.IT = C.Aa : midcircle (C.Bb)
z.I,z.T = get_points(C.IT)
L.TF = C.Bb : tangent_from (z.I)
z.H = intersection (L.TF,C.IT)
z.E = intersection (L.TF,C.Aa)

```

```
z.F=L.TF.pb
}
```

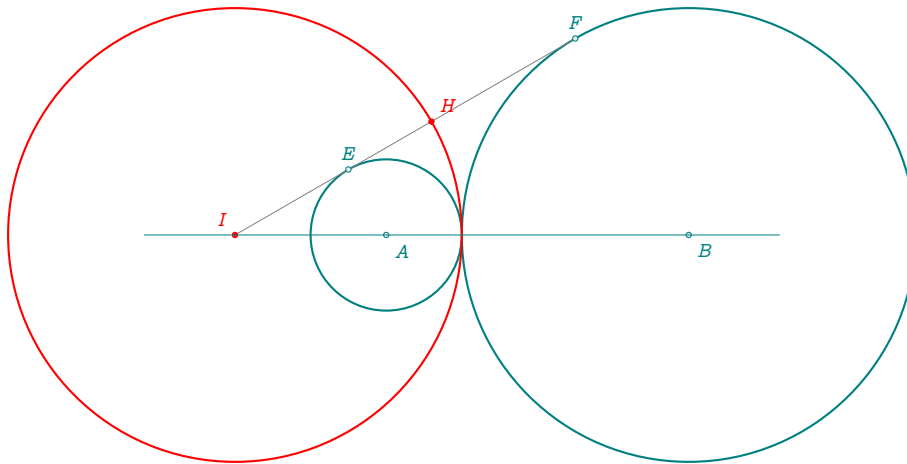

- When one of the given circles is inside and tangent to the other, the construction is easy.

```
\directlua{%
init_elements ()
z.A = point: new ( 2 , 0)
z.B = point: new ( 4 , 0)
z.a = point: new ( 1 , 0)
z.b = point: new ( 1 , 0)
C.Aa = circle: new (z.A,z.a)
C.Bb = circle: new (z.B,z.b)
C.IT = C.Aa: midcircle (C.Bb)
z.I,
z.T = get_points(C.IT)
}
```

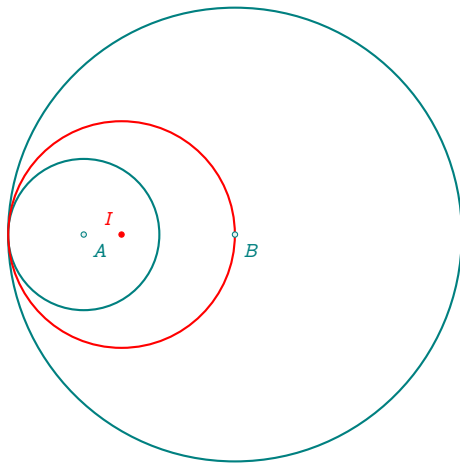

11.2.19 Method `radical_circle`

The radical circle of three given circles is the circle having center at the radical center of the three circles and is orthogonal to all of them. (A circle with center at the radical center that is orthogonal to one of the original circles is always orthogonal to all three.)

[[Weisstein, Eric W. "Radical Circle." From MathWorld—A Wolfram Web Resource.](#)]

```

\directlua{%
init_elements ()
z.A      = point: new (0,0)
z.B      = point: new (6,0)
z.C      = point: new (0.8,4)
T.ABC    = triangle : new ( z.A,z.B,z.C )
C.exa    = T.ABC : ex_circle ()
z.I_a,z.Xa = get_points (C.exa)
C.exb    = T.ABC : ex_circle (1)
z.I_b,z.Xb = get_points (C.exb)
C.exc    = T.ABC : ex_circle (2)
z.I_c,z.Xc = get_points (C.exc)
C.ortho  = C.exa : radical_circle (C.exb,C.exc)
z.w,z.a  = get_points (C.ortho)
}
\begin{tikzpicture}[scale = .5]
  \tkzGetNodes
  \tkzDrawPolygon(A,B,C)
  \tkzDrawCircles(I_a,Xa I_b,Xb I_c,Xc)
  \tkzDrawCircles[red,thick](w,a)
  \tkzDrawPoints(A,B,C)
  \tkzLabelPoints(A,B,C)
\end{tikzpicture}

```

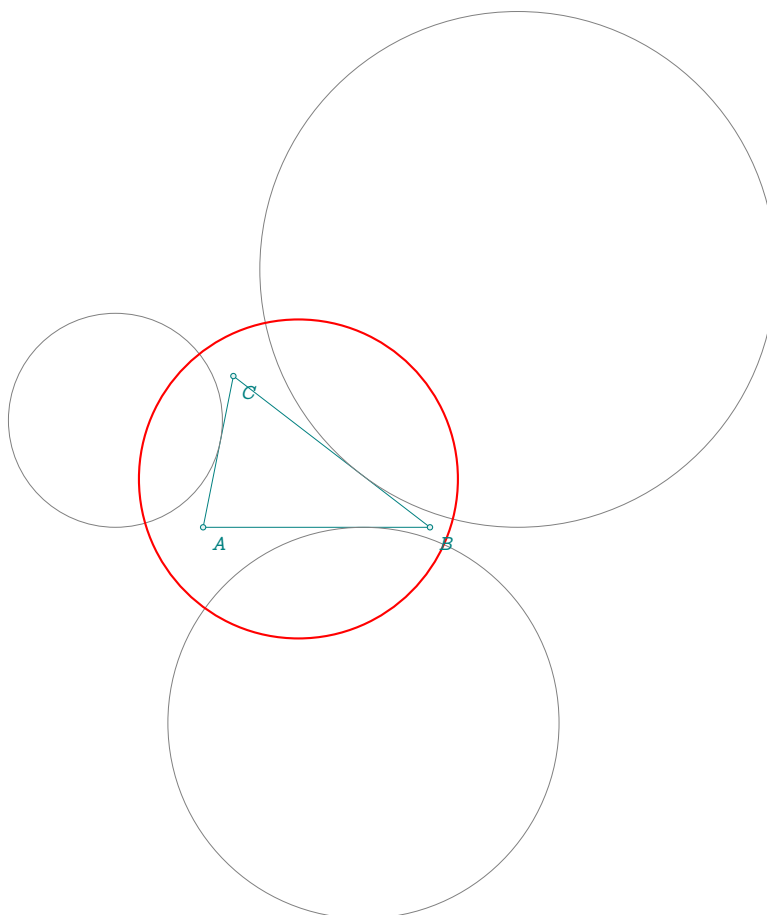

11.2.20 Method power(pt)

The power of a fixed point A with respect to a circle of radius r and center O is defined by the product $p = \overline{AP} \times \overline{AQ} = AM^2 - OT^2$, where P and Q are the intersections of a line through A with the circle and AT is a tangent to the circle.

```
\directlua{
  init_elements ()
  z.O = point: new (5,0)
  z.A = point: new (0,0)
  z.R = point: new (7,0)
  C.OR = circle: new (z.O,z.R)
  z.Q = C.OR: point ( 0.15)
  L.AQ = line:new (z.A,z.Q)
  _,z.P = intersection (C.OR,L.AQ)
  L.T = C.OR : tangent_from(z.A)
  z.T = L.T.pb
}
\begin{tikzpicture}
\tkzGetNodes
\tkzDrawCircle(O,T)
\tkzDrawPoints(A,O,P,Q,T)
\tkzDrawSegments(A,O A,Q A,T)
\tkzLabelPoints(A,O,P,Q,T)
\tkzText(2,2){$p = \tkzUseLua{%
  C.OR: power(z.A)} =AT^2=AP * AQ$}
\end{tikzpicture}
```

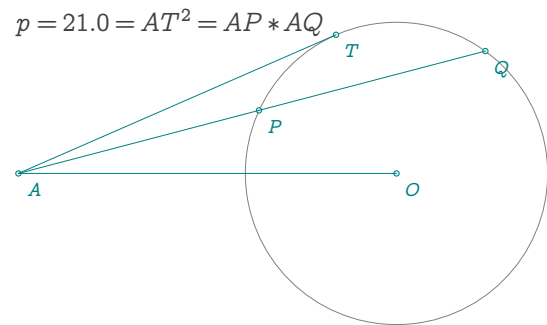

11.2.21 In_out of a disk

```
\directlua{
  init_elements ()
  z.O = point: new (0,0)
  z.R = point: new (2,0)
  z.A = point: new (1,1)
  z.B = point: new (2,-1)
  C.OR = circle: new (z.O,z.R)
  function position (pt)
  if C.OR : power (pt)>0
  then
    return tex.print("out")
  else
    return tex.print("in")
  end
  end
}
\begin{tikzpicture}
\tkzGetNodes
\tkzDrawCircle(O,R)
\tkzDrawPoints(A,O,B)
\tkzLabelPoint(A){\tkzUseLua{position(z.A)}}
\tkzLabelPoint(B){\tkzUseLua{position(z.B)}}
\end{tikzpicture}
```

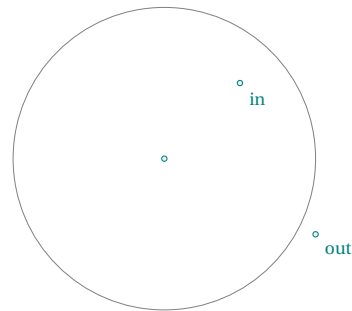

11.2.22 Method `in_out` for circle and disk

```

\directlua{%
  init_elements ()
  z.O = point : new (0,0)
  z.A = point : new (1,2)
  C.OA = circle : new (z.O,z.A)
  z.N = point : new (-2,2)
  z.M = point : new (1,0)
  z.P = point : new (2,1)
  BCm = C.OA : in_out (z.M)
  BDm = C.OA : in_out_disk (z.M)
  BCn = C.OA : in_out (z.N)
  BDn = C.OA : in_out_disk (z.N)
  BCp = C.OA : in_out (z.P)
  BDp = C.OA : in_out_disk (z.P)
}
\def\tkzPosPoint#1#2#3#4{%
\tkzLabelPoints(O,M,N,P)
  \ifthenelse{\equal{\tkzUseLua{#1}}{true}}{
    \tkzLabelPoint[below=#4pt,font=\scriptsize](#2){on the #3}}{%
    \tkzLabelPoint[below=#4pt,font=\scriptsize](#2){out the #3}}
\begin{tikzpicture}
\tkzGetNodes
\tkzDrawSegments[dashed](O,M O,N O,P)
\tkzDrawCircle(O,A)
\tkzDrawPoints(O,M,N,P)
\tkzPosPoint{BCm}{M}{circle}{8}
\tkzPosPoint{BCn}{N}{circle}{8}
\tkzPosPoint{BCp}{P}{circle}{8}
\tkzPosPoint{BDm}{M}{disk}{14}
\tkzPosPoint{BDn}{N}{disk}{14}
\tkzPosPoint{BDp}{P}{disk}{14}
\end{tikzpicture}

```

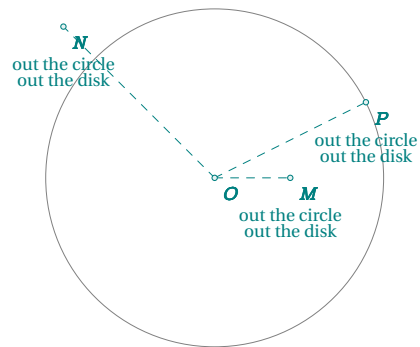
11.2.23 Method `circles_position`

This function returns a string indicating the position of the circle in relation to another. Useful for creating a function. Cases are:

- outside
- outside tangent
- inside tangent
- inside
- intersect

```

\directlua{%
init_elements ()
  z.A      = point : new ( 0 , 0 )
  z.a      = point : new ( 3 , 0 )
  z.B      = point : new ( 2 , 0 )
  z.b      = point : new ( 3 , 0 )
  C.Aa     = circle: new (z.A,z.a)
  C.Bb     = circle: new (z.B,z.b)
  position = C.Aa : circles_position (C.Bb)
  if position == "inside tangent"
  then color = "orange"
  else color = "blue" end
}
\begin{tikzpicture}
  \tkzGetNodes
  \tkzDrawCircle(A,a)
  \tkzDrawCircle[color=\tkzUseLua{color}](B,b)
\end{tikzpicture}

```

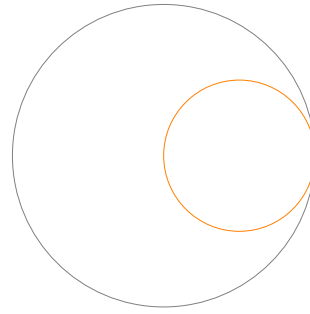

11.2.24 Method c_c_pp

Find a circle tangent to a circle and passing through two given points. If one of the points is on the inside and the other on the outside, then there's no solution.

```

\directlua{
init_elements ()
z.A  = point: new (5,4)
z.B  = point: new (3,0)
z.O  = point: new (0,0)
z.C  = point: new (1,0)
L.AB = line: new ( z.A,z.B )
C.OC = circle: new (z.O,z.C)
C1,C2 = C.OC: c_c_pp (z.A,z.B)
z.O1  = C1.center
z.T1  = C1.through
z.O2  = C2.center
z.T2  = C2.through
}
\begin{tikzpicture}[scale =.75]
\tkzGetNodes
\tkzDrawLines[red](A,B)
\tkzDrawCircle[red](O,C)
\tkzDrawPoints(A,B,C,O)
\tkzDrawCircles[cyan](O1,T1 O2,T2)
\tkzDrawPoints(O1,O2,T1,T2)
\tkzLabelPoints(O1,O2,T1,T2,A,B)
\tkzLabelPoints(O,C,A,B)
\end{tikzpicture}

```

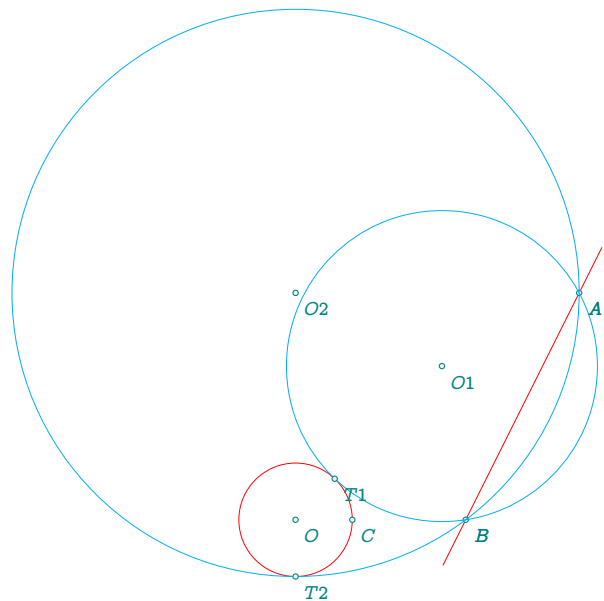

```

\directlua{
  init_elements ()
  z.A      = point: new (3,0)
  z.B      = point: new (0,-3)
  z.O      = point: new (0,0)
  z.C      = point: new (1,0)
  L.AB     = line: new ( z.A,z.B )
  C.OC     = circle: new (z.O,z.C)
  C1,C2    = C.OC: c_c_pp (z.A,z.B)
  z.O1     = C1.center
  z.T1     = C1.through
  z.O2     = C2.center
  z.T2     = C2.through
}

```

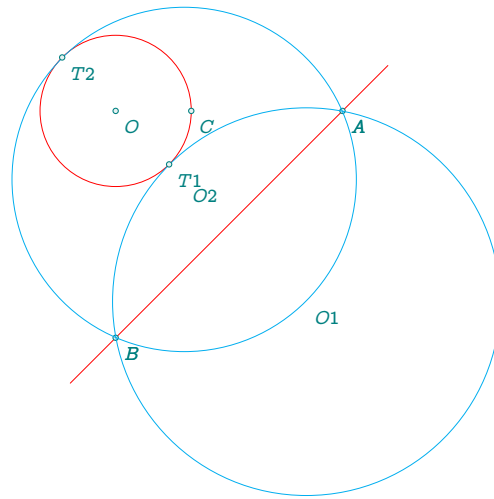

```

\begin{tikzpicture}
\tkzGetNodes
\tkzDrawLines[red](A,B)
\tkzDrawCircle[red](O,C)
\tkzDrawPoints(A,B,C,O)
  \tkzDrawCircles[cyan](O1,T1 O2,T2)
  \tkzDrawPoints(T1,T2)
  \tkzLabelPoints(O1,O2,T1,T2,A,B)
  \tkzLabelPoints(O,C,A,B)
\end{tikzpicture}

```

Special case: the two points are equidistant from the center of the circle

```

\directlua{
  init_elements ()
  z.A      = point: new (2,3)
  z.B      = point: new (2,-3)
  z.O      = point: new (0,0)
  z.C      = point: new (1,0)
  L.AB     = line: new ( z.A,z.B )
  C.OC     = circle: new (z.O,z.C)
  C1,C2    = C.OC: c_c_pp (z.A,z.B)
  z.O1     = C1.center
  z.T1     = C1.through
  z.O2     = C2.center
  z.T2     = C2.through}

```

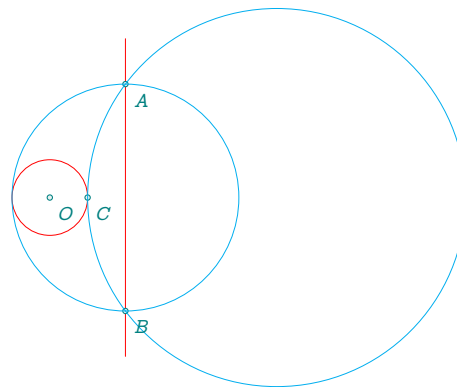

The line (AB) is tangent to the circle. Only one circle answers the question.

```

\directlua{
  init_elements ()
  z.A      = point: new (1,5)
  z.B      = point: new (1,-3)
  z.O      = point: new (0,0)
  z.C      = point: new (1,0)
  L.AB     = line: new ( z.A,z.B )
  C.OC     = circle: new (z.O,z.C)
  C1,C2    = C.OC: c_c_pp (z.A,z.B)
  z.O1     = C1.center
  z.T1     = C1.through
  z.O2     = C2.center
  z.T2     = C2.through
}

```

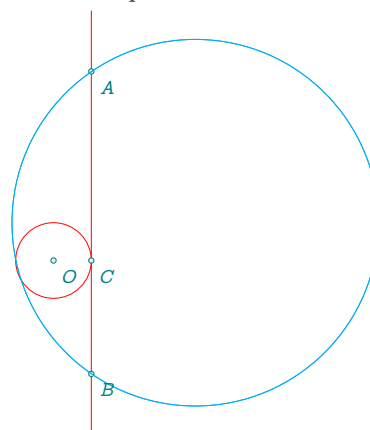

Another special case occurs when the straight line (AB) is tangent to the initial circle, and it's even possible for points A and B to be equidistant from the center and for the straight line to be tangent to the circle. Here too, a single circle answers the question

```

\directlua{
  init_elements ()
  z.A      = point: new (1,3)
  z.B      = point: new (1,-3)
  z.O      = point: new (0,0)
  z.C      = point: new (1,0)
  L.AB     = line: new ( z.A,z.B )
  C.OC     = circle: new (z.O,z.C)
  C1,C2    = C.OC: c_cc_pp (z.A,z.B)
  z.O1     = C1.center
  z.T1     = C1.through
  z.O2     = C2.center
  z.T2     = C2.through
}

```

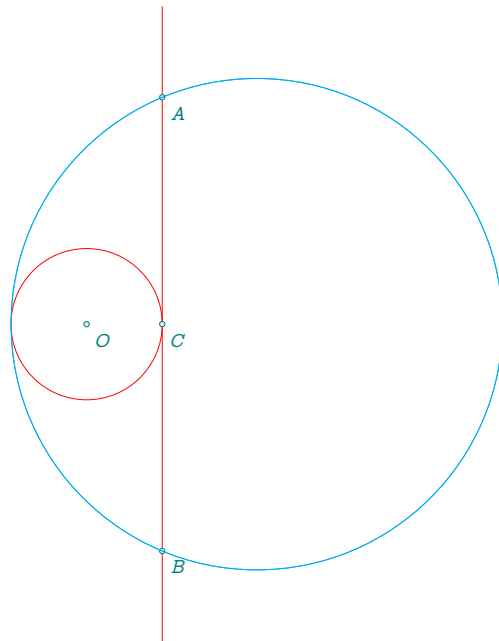

11.2.25 Method c_cc_p

Circle tangent to two circles passing through a point

Let's begin with the general case. The two circles are disjoint, and point P lies outside both of them. Notice that the two solution circles intersect at two points, one of which is the given point P . To determine the second intersection point, I used a similitude. This approach leads to an intriguing special case known as the Arbelos configuration. In this arrangement, the solution circles are also tangent at point P . One of the circles, in this case, is the Pappus circle.

```

\directlua{
  init_elements()
  z.A = point : new ( 0 , 0 )
  z.TA = point : new ( 3 , 0 )
  z.B = point : new ( 6 , 2 )
  z.TB = point : new ( 6 , 1 )
  z.P = point : new ( 3 , 6 )
  C.A = circle : new (z.A,z.TA)
  C.B = circle : new (z.B,z.TB)
  C1,C2= C.A : c_cc_p (C.B,z.P)
  z.O1 = C1.center
  z.O2 = C2.center
  z.T1 = C1.through
  z.T2 = C2.through
}
\begin{tikzpicture}[scale = .75]
\tkzGetNodes
\tkzDrawCircles[thick](A,TA B,TB)
\tkzDrawCircles[red](O1,T1 O2,T2)
\tkzDrawPoints(A,B,O1,O2)
\tkzLabelPoints(A,B)
\tkzDrawPoints[size=3](P)
\tkzLabelPoints[above](P)
\end{tikzpicture}

```

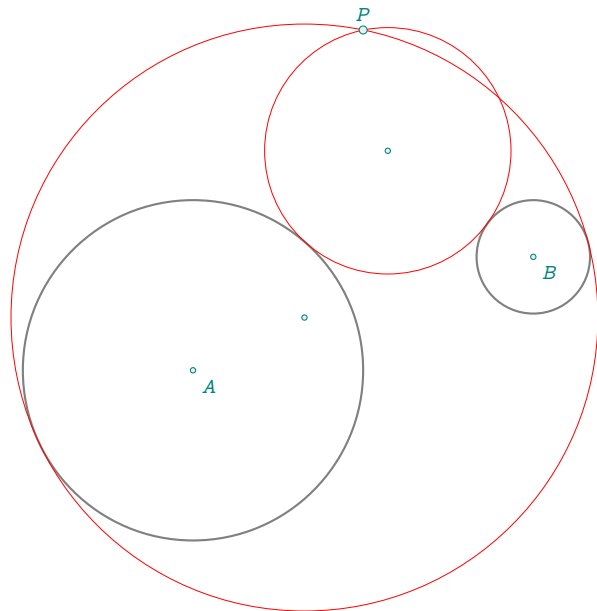

The first special case involves two given tangent circles. The point P is not the point of tangency of the Pappus circle.

```

\directlua{
z.A = point : new ( 0 , 0 )
z.TA = point : new ( 2 , 0 )
z.B = point : new ( 3 , 0 )
z.TB = point : new ( 2 , 0 )
z.P = point : new ( 3 , 4 )
C.A = circle : new (z.A,z.TA)
C.B = circle : new (z.B,z.TB)
C1,C2 = C.A : c_cc_p (C.B,z.P)
z.O1 = C1.center
z.O2 = C2.center
z.T1 = C1.through
z.T2 = C2.through
}

```

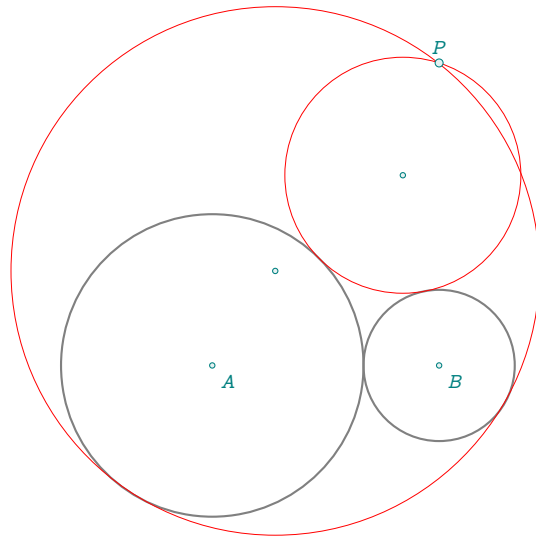

Here's the Arbelos configuration

```

\directlua{
z.A = point : new ( 0 , 0 )
z.TA = point : new ( 2 , 0 )
z.B = point : new ( 3 , 0 )
z.TB = point : new ( 2 , 0 )
C.A = circle : new (z.A,z.TA)
C.B = circle : new (z.B,z.TB)
z.I = C.A: external_similitude (C.B)
z.t1,z.t2 = C.A : common_tangent (C.B)
z.TD = C.B : antipode(z.TB)
z.TE = C.A : antipode(z.TA)
z.O = midpoint(z.TD,z.TE)
C.O = circle : new (z.O,z.TD)
z.P = C.O : tangent_from (z.I).pb
C1,C2 = C.A : c_cc_p (C.B,z.P)
z.O1 = C1.center
z.O2 = C2.center
z.T1 = C1.through
z.T2 = C2.through
}

```

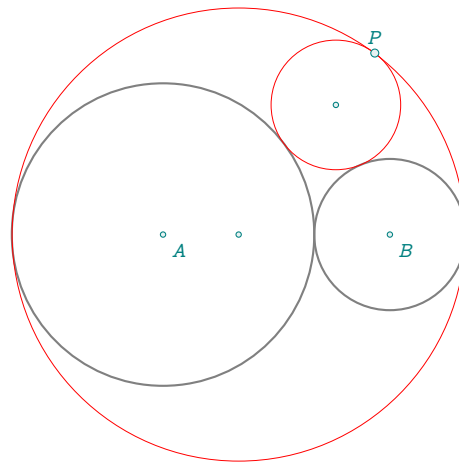

If the point P is not the contact point of the Pappus circle, we return to the general case.

```

\directlua{
z.A      = point : new ( 0 , 0 )
z.TA     = point : new ( 2 , 0 )
z.B      = point : new ( 3 , 0 )
z.TB     = point : new ( 2 , 0 )
C.A      = circle : new (z.A,z.TA)
C.B      = circle : new (z.B,z.TB)
z.I      = C.A: external_similitude (C.B)
z.t1,z.t2 = C.A : common_tangent (C.B)
z.TD     = C.B : antipode(z.TB)
z.TE     = C.A : antipode(z.TA)
z.O      = midpoint(z.TD,z.TE)
C.O      = circle : new (z.O,z.TD)
z.P      = C.O : tangent_from (z.I).pb
C1,C2    = C.A : c_cc_p (C.B,z.P)
z.O1     = C1.center
z.O2     = C2.center
z.T1     = C1.through
z.T2     = C2.through
}

```

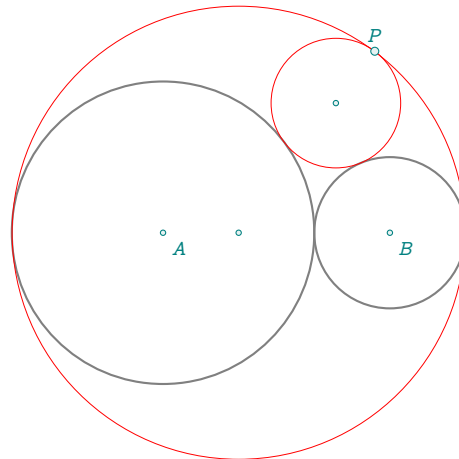

11.2.26 Method `c_lc_p`

Circle tangent to a line and a circle passing through a given point.

First, let's look at the general case. The point and the circle are in the same half-plane with respect to the line. The point is neither on the line nor on the circle.

There are 4 circles verifying the conditions. Two are tangent externally, and two internally to the initial circle. The latter two are obtained with the inside argument.

```

\directlua{
z.A = point : new (0 , 0)
z.B = point : new (4 , 0)
L.AB = line : new (z.A,z.B)
z.O = point : new (3 , 3)
z.T = point : new (3 , 2)
z.P = point : new (2 , .25)
C.OT = circle : new (z.O , z.T)
C1,C2 = C.OT : c_lc_p (L.AB , z.P)
z.O1 = C1.center
z.O2 = C2.center
C3,C4 = C.OT : c_lc_p (L.AB , z.P,inside)
z.O3 = C3.center
z.O4 = C4.center
}

```

```

\begin{tikzpicture}
\tkzGetNodes
\tkzDrawCircles[thick](O,T)
\tkzDrawCircles[red](O1,P O2,P)
\tkzDrawCircles[cyan](O3,P O4,P)
\tkzDrawLines[thick](A,B)
\tkzDrawPoints[size = 2](P)
\tkzDrawPoints(A,B,O,O1,O2,O3,O4)
\tkzLabelPoints(A,B,O,O1,O2,O3,O4)
\tkzLabelPoints[above](P)
\end{tikzpicture}

```

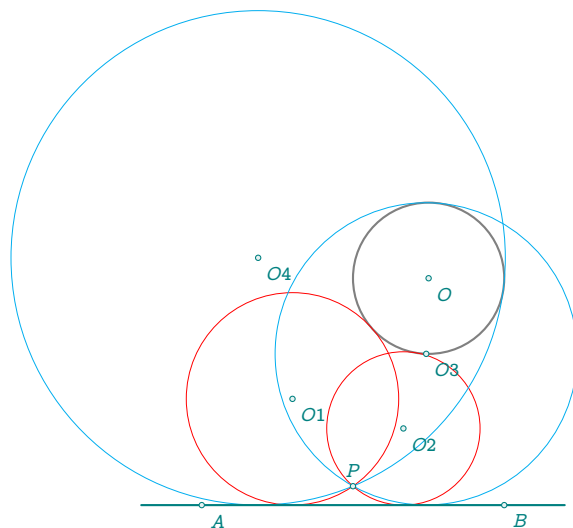

12 Class triangle

12.1 Attributes of a triangle

The triangle object is created using the new method, for example with

```
Creation T.ABC = triangle : new ( z.A , z.B , z.C )
```

(Refer to examples: 26.7; 26.9; 26.16). Multiple attributes are then created.

Table 9: Triangle attributes.

Attributes	Application
pa	T.ABC.pa
pb	T.ABC.pb
pc	T.ABC.pc
type	'triangle'
circumcenter	T.ABC.circumcenter; [12.2.1]
centroid	T.ABC.centroid
incenter	T.ABC.incenter
orthocenter	T.ABC.orthocenter
eulercenter	T.ABC.eulercenter
spiekercenter	T.ABC.spiekercenter; [3.1.4]
a	It's the length of the side opposite the first vertex
b	It's the length of the side opposite the second vertex
c	It's the length of the side opposite the third vertex
alpha	Vertex angle of the first vertex
beta	Vertex angle of the second vertex
gamma	Vertex angle of the third vertex
ab	Line defined by the first two points of the triangle
bc	Line defined by the last two points
ca	Line defined by the last and the first points of the triangle
semiperimeter	semiperimeter of the triangle
area	area of the triangle
inradius	radius of the incircle
circumradius	radius of the circumcircle

12.2 Triangle attributes: angles

```
\directlua{%
init_elements ()
  z.A      = point: new(0,0)
  z.B      = point: new(5,0)
  z.C      = point: new(2,3)
  T.ABC    = triangle: new (z.A,z.B,z.C)
}
\def\wangle#1{\tkzDN[2]{%
  \tkzUseLua{math.deg(T.ABC.#1)}}}
\begin{tikzpicture}
\tkzGetNodes
  \tkzDrawPolygons(A,B,C)
  \tkzLabelAngle(B,A,C){$\wangle{\alpha}^\circ$}
  \tkzLabelAngle(C,B,A){$\wangle{\beta}^\circ$}
  \tkzLabelAngle(A,C,B){$\wangle{\gamma}^\circ$}
\end{tikzpicture}
```

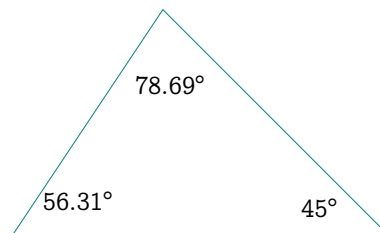

12.2.1 Example: triangle attributes

```

\directlua{%
init_elements ()
  z.A = point: new (0 , 0)
  z.B = point: new (4 , 0)
  z.C = point: new (0 , 3)
  T.ABC = triangle : new (z.A,z.B,z.C)
  z.O = T.ABC.circumcenter
  z.I = T.ABC.incenter
  z.H = T.ABC.orthocenter
  z.G = T.ABC.centroid
  a = T.ABC.a
  b = T.ABC.b
  c = T.ABC.c
  alpha = T.ABC.alpha
  beta = T.ABC.beta
  gamma = T.ABC.gamma
}
\begin{tikzpicture}
  \tkzGetNodes
  \tkzDrawPolygon(A,B,C)
  \tkzDrawPoints(A,B,C,O,G,I,H)
  \tkzLabelPoints[below] (A,B,O,G,I)
  \tkzLabelPoints[above right] (H,C)
  \tkzDrawCircles(O,A)
  \tkzLabelSegment[sloped] (A,B){\tkzUseLua{c}}
  \tkzLabelSegment[sloped,above] (B,C){\tkzUseLua{a}}
\end{tikzpicture}

```

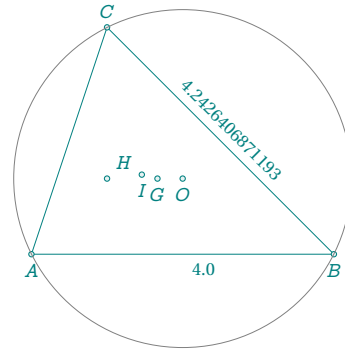

12.3 Methods of the class triangle

Table 10: triangle methods.

Methods	Comments	
<code>new (a, b, c)</code>	<code>T.ABC = triangle : new (z.A, z.B, z.C)</code>	[12.2] ^a
Booleans		
<code>in_out (pt)</code>	Boolean. Test if pt is inside the triangle	
<code>check_equilateral ()</code>	Boolean. Test if the triangle is equilateral	
<code>check_acutangle ()</code>	Boolean. Test if the triangle is acutangle	
Reals		
<code>area ()</code>	$\mathcal{A} = T.ABC$: <code>area ()</code> better <code>T.ABC.area</code>	
<code>barycentric_coordinates(pt)</code>	Triples of numbers (masses placed at the vertices)	
Points		
<code>lemoine_point ()</code>	<code>T.ABC : lemoine_point ()</code> intersection of the symmedians	[10.2.9]
<code>symmedian_point ()</code>	Lemoine point or the Grebe point	[12.3.27]
<code>lemoine_point ()</code>	symmedian point or the Grebe point	[12.3.27]
<code>bevan_point ()</code>	Circumcenter of the excentral triangle	[12.3.21]
<code>mittenpunkt_point ()</code>	Symmedian point of the excentral triangle	[12.3.3]
<code>gergonne_point ()</code>	Intersection of the three cevians that lead to the contact points	[12.3.1]
<code>nagel_point ()</code>	Intersection of the three cevians that lead to the extouch points	[12.3.2]
<code>feuerbach_point ()</code>	The point at which the incircle and euler circle are tangent.	[12.3.22]
<code>spieker_center ()</code>	Incenter of the medial triangle	[26.34]
<code>barycentric (ka, kb, kc)</code>	<code>T.ABC: barycentric (2, 1, 1)</code>	Remark ^b
<code>base (u, v)</code>	<code>z.D = T.ABC: base(1, 1)</code> ABDC is a parallelogram	[12.3.8]
<code>trilinear (u, v, w)</code>	<code>z.D = T.ABC: trilinear(1, 1, 1)</code> ABDC parallelogram	[12.3.6]
<code>projection (p)</code>	Projection of a point on the sides	[26.23; 12.3.4]
<code>euler_points()</code>	Euler points of euler circle	[12.3.9]
<code>nine_points()</code>	9 Points of the euler circle	[12.3.10]
<code>taylor_points()</code>	Points on the Taylor circle	Refer to [12.3.39]
<code>parallelogram()</code>	<code>z.D = T.ABC: parallelogram()</code> ABCD parallelogram	[26.18]
<code>kimberling (n)</code>	<code>z.X = T.ABC : kimberling (115)</code>	Refer to [12.3.5]
<code>isogonal (p)</code>		Refer to [12.3.40]
Lines		
<code>altitude (n)</code>	<code>L.AHa = T.ABC : altitude ()</code> n empty or 0 line from A^c	[12.3.11]
<code>bisector (n)</code>	<code>L.Bb = T.ABC : bisector (1)</code> n = 1 line from B^d	[12.3.12]
<code>bisector_ext(n)</code>	n=2 line from the third vertex.	[12.3.32]
<code>symmedian_line (n)</code>	Cevian with respect to Lemoine point.	[12.3.27 ; 10.2.9]
<code>euler_line ()</code>	the line through N, G, H and O if the triangle is not equilateral ^e	[26.32]
<code>antiparallel(pt, n)</code>	n=0 antiparallel through pt to (BC) , n=1 to (AC) etc.	[26.54]
<code>steiner_line(pt)</code>		[12.3.34]
<code>simson_line(pt)</code>		[12.3.35; 26.22.1]
<code>lemoine_axis()</code>		[12.3.36]
<code>brocard_axis()</code>		[12.3.37]
<code>fermat_axis()</code>		

^a T or T.name with what you want for name, is possible.

^b The function `barycenter` is used to obtain the barycentre for any number of points

^c `z.Ha = L.AHa.pb` recovers the common point of the opposite side and altitude. The method `orthic` is usefull. If you don't need to use the triangle object several times, you can obtain a bisector or a altitude with the function `altitude (z.A, z.B, z.C)` ; [29]

^d `_, z.b = get_points(L.Bb)` recovers the common point of the opposite side and bisector. If you don't need to use the triangle object several times, you can obtain a bisector with the function `bisector (z.A, z.B, z.C)` [29]

^e N center of nine points circle, G centroid, H orthocenter, O circum center

Methods	Comments	
Circles		
euler_circle ()	C.NP = T.ABC : euler_circle () -> <i>N</i> euler point ^a	[12.3.13]
circum_circle ()	C.OA = T.ABC : circum () Triangle's circumscribed circle	[12.3.14]
in_circle ()	Inscribed circle of the triangle	[12.3.15]
ex_circle (n)	External circle tangent to a side of the triangle ; n swap	[12.3.16]
first_lemoine_circle ()		[26.52]
second_lemoine_circle ()		[26.54]
spieker_circle ()	The incircle of the medial triangle	[12.3.17]
bevan_circle ()	Circumscribed circle of an excentral triangle	[12.3.21]
cevian_circle ()	Circumscribed circle of a Cevian triangle	[12.3.18]
symmedial_circle ()	Circumscribed circle of a symmedial triangle	[12.3.27]
pedal_circle ()	Circumscribed circle of the podar triangle	[12.3.19]
conway_circle ()	Circumscribed circle of Conway points	[12.3.20]
taylor_circle ()	Circumscribed circle of Conway points	[12.3.39]
c_ll_p (pt)	circle tgt to two side through pt [12.3.33]	
Triangles		
orthic ()	T = T.ABC : orthic () joining the feet of the altitudes	[12.3.11]
medial ()	T = T.ABC : medial () with vertices at the midpoints; [12.3.24	26.26 ; 12.3.27]
incentral ()	Cevian triangle of the triangle with respect to its incenter.	[12.3.25]
excentral ()	With vertices corresponding to the excenters.	[12.3.22]
extouch ()	With the points of tangency with the excircles.	[26.16]
intouch ()	Contact triangle formed by the points of tangency of the incircle	[12.3.1]
contact ()	contact = intouch ; [12.3.1]	
tangential ()	With the lines tangent to the circumcircle at the vertices;	[12.3.26]
feuerbach ()	With the points of tangency of the euler circle with the excircles	[12.3.22]
anti ()	Anticomplementary Triangle The given triangle is its medial triangle. ^b	[12.3.28]
cevian (pt)	With the endpoints of the three cevians with respect to pt	[12.3.18]
pedal (pt)	With projections onto the sides of pt	[12.3.19]
symmedial ()	With the intersection points of the symmedians ;	[12.3.27]
euler ()	With the euler points	[12.3.9]
similar ()	With straight lines parallel to the sides	[12.3.23]
Ellipses		
steiner_inellipse ()	[ex. 12.3.31]	
steiner_circumellipse ()	[ex. 12.3.31]	
euler_ellipse ()	[ex. (12.3.30)]	

^a The midpoint of each side of the triangle, the foot of each altitude, the midpoint of the line segment from each vertex of the triangle to the orthocenter.

^b You can use **similar** instead of **anti**.

12.3.1 Method gergonne_point

In this example, some useful methods are applied like `intouch` or `contact`. The points of contact of the inscribed circle (incircle) with the triangle in question are obtained.

```

\directlua{%
init_elements ()
z.a = point: new(1,0)
z.b = point: new(6,2)
z.c = point: new(2,5)
T = triangle : new (z.a,z.b,z.c)
z.g = T : gergonne_point ()
z.i = T.incenter
z.ta,z.tb,z.tc = get_points (T : intouch ())
}
\begin{tikzpicture}
\tkzGetNodes
\tkzDrawPolygons(a,b,c)
\tkzDrawSegments (a,ta b,tb c,tc)
\tkzDrawCircle(i,ta)
\tkzDrawPoints(a,b,c,g,ta,tb,tc)
\tkzLabelPoints(a,b,tc)
\tkzLabelPoints[above] (c,ta)
\tkzLabelPoints[above left] (tb)
\end{tikzpicture}

```

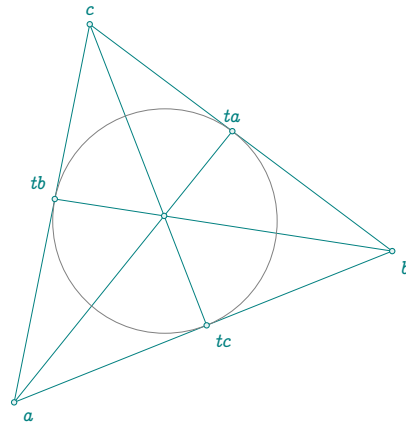

12.3.2 Method Nagel_point

Let E_a be the point at which the J_a -excircle meets the side (BC) of a triangle ABC , and define E_b and E_c similarly. Then the lines A, E_a, B, E_b and C, E_c concur in the Nagel point Na .

```

\directlua{%
init_elements ()
z.A = point : new (0,0)
z.B = point : new (3.6,0)
z.C = point : new (2.8,4)
T.ABC = triangle: new (z.A,z.B,z.C)
z.Na = T.ABC : nagel_point ()
z.J_a,z.J_b,
z.J_c = get_points (T.ABC : excentral ())
z.E_a,z.E_b,
z.E_c = get_points (T.ABC : extouch ())
}
\begin{tikzpicture}[scale= .7]
\tkzGetNodes
\tkzDrawPoints(A,B,C)
\tkzDrawPoints[red,size=2](J_a,J_b,J_c)
\tkzClipBB
\tkzDrawLines[add=1.75 and 1.75,teal](A,B A,C B,C)
\tkzDrawCircles(J_a,E_a J_b,E_b J_c,E_c)
\tkzDrawSegments[dashed,gray](J_a,E_a J_b,E_b J_c,E_c)
\tkzDrawSegments[orange](A,E_a B,E_b C,E_c)
\tkzDrawPoints[red,size=2](Na,E_a,E_b,E_c)
\tkzLabelPoints(A,B,Na)
\tkzLabelPoints(E_c,J_a,J_b,J_c)
\tkzLabelPoints[above](E_a,E_b,C)
\end{tikzpicture}

```

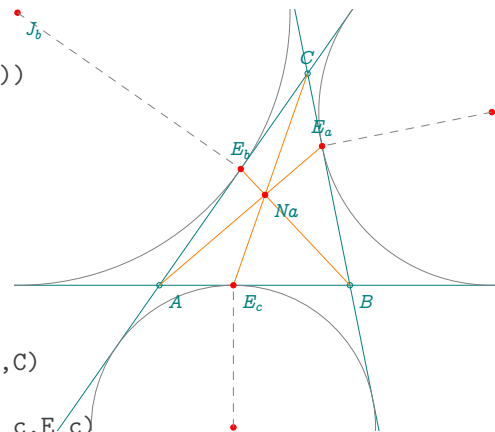

12.3.3 Method mittenpunkt

The Mittenpunkt is the symmedian point of the excentral triangle. The mittenpunkt (also called the middles-point) of a triangle is the symmedian point of the excentral triangle, i.e., the point of concurrence of the lines

from the excenters through the corresponding triangle side midpoints. [Weisstein, Eric W. "Mittelpunkt." From MathWorld—A Wolfram Web Resource.]

```
\directlua{%
init_elements ()
  z.A = point : new ( 0 , 0 )
  z.B = point : new ( 6 , 0 )
  z.C = point : new ( 4 , 6 )
  T = triangle : new (z.A,z.B,z.C)
  z.Ma,
  z.Mb,
  z.Mc = get_points (T : medial ())
  z.Ia,z.Ib,z.Ic = get_points(T : excentral ())
  z.Mi = T : mittelpunkt_point ()
  T.int = T : extouch ()
  z.Ta,z.Tb,z.Tc = get_points(T.int)
}
\begin{tikzpicture}[scale=.5]
  \tkzGetNodes
  \tkzDrawPolygons[] (A,B,C Ma,Mb,Mc)
  \tkzDrawPoints (Ma,Mb,Mc, Ia,Ib,Ic)
  \tkzDrawPoints[red] (Ta,Tb,Tc)
  \tkzLabelPoints[below] (Ib)
  \tkzLabelPoints[above left] (Ia,Ic)
  \tkzClipBB
  \tkzDrawLines[add=0 and 1] (Ia,Ma Ib,Mb Ic,Mc)
  \tkzDrawLines[add=1 and 1] (A,B A,C B,C)
  \tkzDrawCircles[red] (Ia,Ta Ib,Tb Ic,Tc)
  \tkzDrawPoints (B,C,A,Mi)
  \tkzLabelPoints (B,A)
  \tkzLabelPoints[above] (C,Mi)
\end{tikzpicture}
```

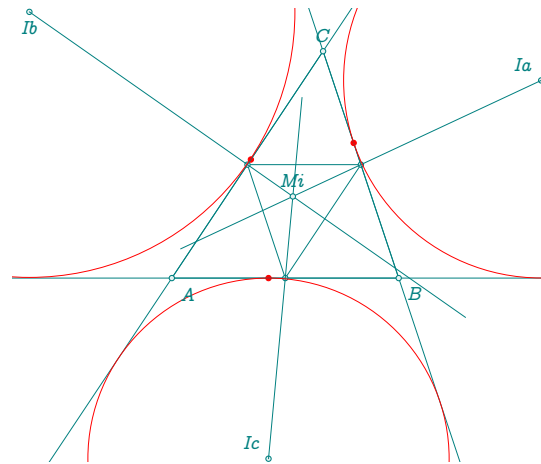

12.3.4 Method projection

This involves obtaining the projections of a point onto the sides of a triangle. In the following example, we are going to find the projections of a centre of an exinscribed circle.

```

\directlua{%
init_elements ()
z.A = point: new (0 , 0)
z.B = point: new (5 , 0)
z.C = point: new (-.4 , 4)
T.ABC = triangle: new (z.A,z.B,z.C)
z.J,_ = get_points(T.ABC: ex_circle (2))
z.X ,
z.Y,
z.Z = T.ABC : projection (z.J)
}

```

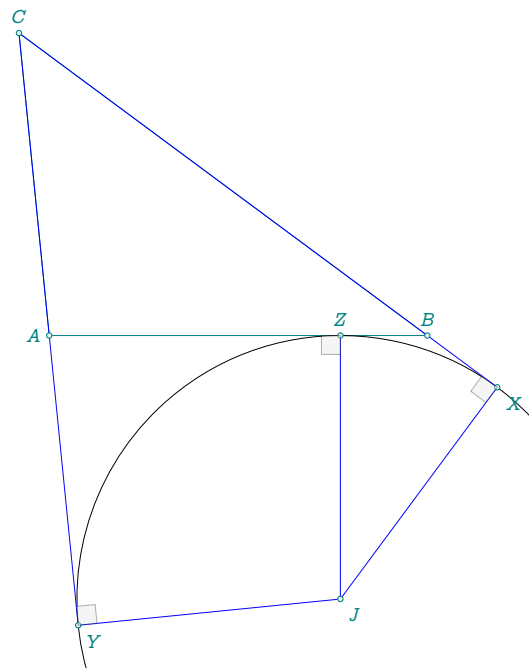

```

\begin{center}
\begin{tikzpicture}
\tkzGetNodes
\tkzDrawPolygon(A,B,C)
\tkzDrawArc(J,X)(Y)
\tkzDrawSegments[blue](J,X J,Y J,Z C,Y C,X)
\tkzDrawPoints(A,B,C,J,X,Y,Z)
\tkzLabelPoints(J,X,Y)
\tkzLabelPoints[above](C,B,Z)
\tkzLabelPoints[left](A)
\tkzMarkRightAngles[fill=gray!20,opacity=.4](A,Z,J A,Y,J J,X,B)
\end{tikzpicture}
\end{center}

```

12.3.5 Method kimberling

C. Kimberling has extensively tabulated and enumerated the properties of triangle centers (Kimberling 1994, 1998, and online), denoting the n th center in his numbering scheme by X_n . 101 (plus 13 additional) centers appeared in Kimberling (1994), 360 in Kimberling (1998), and the remainder appear in a list maintained online by Kimberling at [\[1\]](#). In his honor, these centers are called Kimberling centers in this work. Kimberling's compilation contains 3053 centers as of December 2004. A subset of these is illustrated above.

[Weisstein, Eric W. "Kimberling Center." From MathWorld—A Wolfram Web Resource.]

Only a few centers can be used with this method; here is the current list: 1, 2, 3, 4, 5, 6, 7, 8, 9, 10, 11, 12, 13, 14, 19, 20, 110, 115.

Here's an example:

```

\directlua{
  init_elements ()
  z.B      = point: new (0,0)
  z.C      = point: new (4,0)
  z.A      = point : new (1,3.2)
  T        = triangle: new(z.A,z.B,z.C)
  z.H      = T : kimberling (4)
  z.O      = T : kimberling (3)
  L.euler  = line : new (z.O,z.H)
  z.F      = T : kimberling (110)
  kiepert  = conic : new (z.F,L.euler,1)
  curve    = kiepert : points (-4,4,50)
  z.ea,z.eb = get_points(L.euler) }
\begin{tikzpicture}
  \tkzGetNodes
  \tkzDrawLines[cyan,add= .5 and .5](A,C A,B A,C)
  \tkzDrawPolygon[cyan](A,B,C)
  \tkzDrawCoordinates[smooth,red](curve)
  \tkzDrawLines[red,add= .5 and .5](ea,eb)
  \tkzDrawPoints(A,B,C,F,O,H)
  \tkzLabelPoints(A,B,C,F,O,H)
\end{tikzpicture}

```

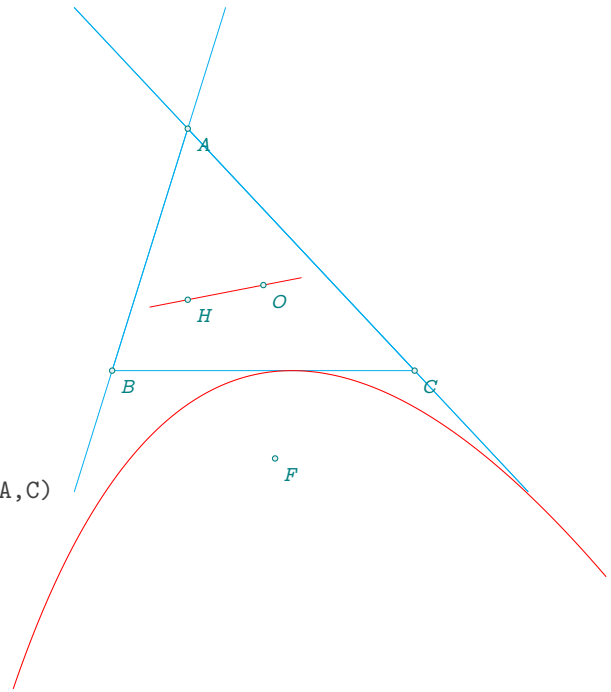

12.3.6 Method trilinear

Given a reference triangle ABC , the trilinear coordinates of a point P with respect to ABC are an ordered triple of numbers, each of which is proportional to the directed distance from P to one of the side lines. Trilinear coordinates are denoted $\alpha:\beta:\gamma$ or (α,β,γ) and also are known as homogeneous coordinates or "trilinears." Trilinear coordinates were introduced by Plücker in 1835. [Weisstein, Eric W. "Trilinear Coordinates." From MathWorld—A Wolfram Web Resource.]

```

\directlua{%
  init_elements ()
  z.A = point : new ( 0 , 0 )
  z.B = point : new ( 4 , 0 )
  z.C = point : new ( 4 , 3 )
  T.ABC = triangle : new ( z.A , z.B , z.C )
  a = T.ABC.a
  b = T.ABC.b
  c = T.ABC.c
  z.Gp = T.ABC : trilinear (b*c,a*c,a*b)
  z.G = T.ABC : barycentric (1,1,1)
}
\begin{tikzpicture}
  \tkzGetNodes
  \tkzDrawPolygon(A,B,C)
  \tkzDrawPoints(A,B,C,G',G)
  \tkzLabelPoints(A,B,G')
  \tkzLabelPoints[above](C,G)
\end{tikzpicture}

```

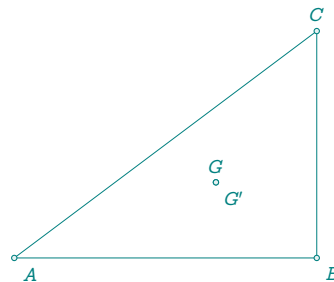

12.3.7 Method barycentric_coordinates

This method produces a triplet of coordinates which are the barycentric coordinates of a point as a function of the three points of a given triangle.

```

\directlua{%
init_elements ()
  z.A      = point: new (1,1)
  z.B      = point: new (8,0)
  z.C      = point: new (2,5)
  T        = triangle: new(z.A,z.B,z.C)
  z.G      = T.centroid
  ca,cb,cc = T : barycentric_coordinates (z.G)
}
\begin{tikzpicture}
  \tkzGetNodes
  \tkzDrawPolygons(A,B,C)
  \tkzDrawPoints(A,B,C,G)
  \tkzLabelPoints(A,B,C,G)
  \tkzLabelPoint(G){\pmpn{\tkzUseLua{ca}}:\pmpn{\tkzUseLua{cb}}:\pmpn{\tkzUseLua{cc}}}
\end{tikzpicture}

```

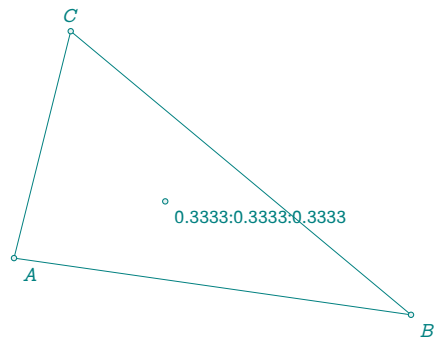

12.3.8 Method base

In the next example, the point D is defined by $\overrightarrow{AD} = 1 \cdot \overrightarrow{AB} + 1 \cdot \overrightarrow{AC}$.

```

\directlua{%
init_elements ()
  z.A      = point: new (1,1)
  z.B      = point: new (8,0)
  z.C      = point: new (0,5)
  z.X      = point: new (2,2)
  T        = triangle: new(z.A,z.B,z.C)
  z.D      = T : base (1,1)
  z.E      = T : base (.5,1)
}
\begin{tikzpicture}[scale = .75]
  \tkzGetNodes
  \tkzDrawPolygons(A,B,D,C A,B,E,C)
  \tkzDrawPoints(A,B,C,D,E)
  \tkzLabelPoints(A,B)
  \tkzLabelPoints[above](C,D,E)
\end{tikzpicture}

```

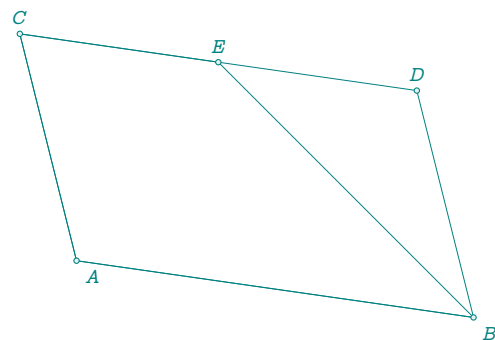

12.3.9 Method euler_points

The points a , b and c are the Euler points. They are the midpoints of the segments AH , BH and CH .

```

\directlua{%
  init_elements ()
  z.A      = point: new (0,0)
  z.B      = point: new (5,0)
  z.C      = point: new (1,4)
  T        = triangle: new(z.A,z.B,z.C)
  z.N      = T.eulercenter
  z.a,
  z.b,
  z.c      = get_points (T : euler ())
  z.H      = T.orthocenter
  T.orthic = T: orthic()
  z.Ha,
  z.Hb,
  z.Hc     = get_points (T.orthic)
}
\begin{tikzpicture}[scale      = 1.25]
  \tkzGetNodes
  \tkzDrawPolygons[red] (A,B,C)
  \tkzDrawPolygons[cyan] (a,b,c)
  \tkzDrawCircle[purple] (N,a)
  \tkzDrawPoints(a,b,B,C,A,c,H)
  \tkzDrawSegments[red] (C,Hc B,Hb A,Ha)
  \tkzLabelPoints(A,B,a,b,H)
  \tkzLabelPoints[above] (c,C)
\end{tikzpicture}

```

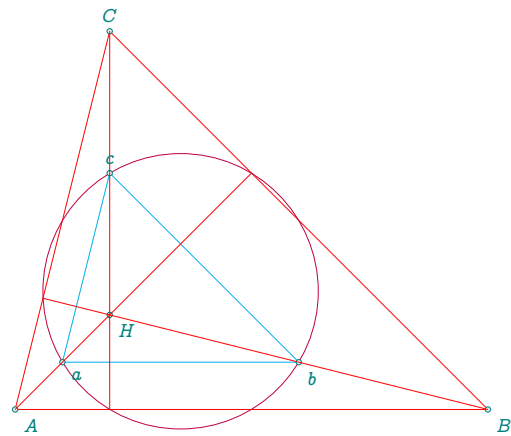

12.3.10 Method nine_points

This method gives the nine main points belonging to the Euler circle: in order, first the midpoints of the sides of the triangle, then the feet of the altitudes and finally the three Euler points. Refer to the last example. In the next example, we look for the centre of gravity in two different ways: the first uses the trilinear method, the second the barycentric method.

```

\directlua{%
  init_elements ()
  z.A      = point: new (0,0)
  z.B      = point: new (5,0)
  z.C      = point: new (1,4)
  T        = triangle: new(z.A,z.B,z.C)
  z.N      = T.eulercenter
  z.e1,
  z.e2,
  z.e3,
  z.e4,
  z.e5,
  z.e6,
  z.e7,
  z.e8,
  z.e9     = T : nine_points ()
}

```

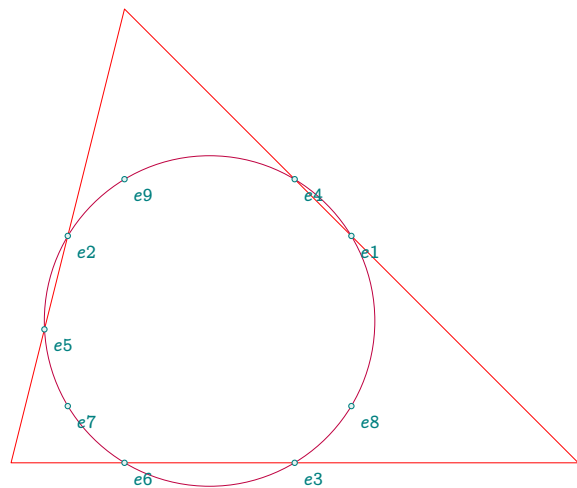

```

\begin{tikzpicture}[ scale = 1.5]
  \tkzGetNodes
  \tkzDrawPolygons[red](A,B,C)
  \tkzDrawCircle[purple](N,e1)
  \tkzDrawPoints(e1,e2,e3,e4,e5,e6,e7,e8,e9)
  \tkzLabelPoints(e1,e2,e3,e4,e5,e6,e7,e8,e9)
\end{tikzpicture}

```

12.3.11 Method altitude

There are several methods to obtain one or more altitudes of a triangle. One possible method is the orthic method. This method allows for defining the orthic triangle whose vertices are the feet of the altitudes from each vertex. If only one altitude is needed, one can use the `altitude(n)` method. The numeric value n can be 0, 1, or 2. By default, if it is absent, it is considered to be 0. Considering the triangle ABC , $n = 0$ means no cyclic permutation of the vertices, and the altitude will be from the first point, here A . If $n = 1$, the point trio BCA is considered, and the altitude will be from B . For $n = 2$, the altitude will be from C .

```

\directlua{%
init_elements ()
  z.A      = point: new (0,0)
  z.B      = point: new (5,0)
  z.C      = point: new (2,4)
  T        = triangle: new(z.A,z.B,z.C)
  z.H      = T.orthocenter
  L.HA     = T : altitude ()
  L.HC     = T :altitude (2)
  z.Hc     = L.HC.pb
  z.Ha     = L.HA.pb
  z.a,z.b,z.c = get_points (T : orthic ())
}
\begin{tikzpicture}
  \tkzGetNodes
  \tkzDrawPolygon(A,B,C)
  \tkzDrawPolygon[red](a,b,c)
  \tkzDrawPoints(A,B,C,H)
  \tkzDrawSegments[red](C,Hc A,Ha)
  \tkzLabelPoints(A,B,H)
  \tkzLabelPoints[font=\small](Hc)
  \tkzLabelPoints[font=\small,above](Ha,C)
  \tkzMarkRightAngles[fill = gray!30,opacity=.4](B,Hc,C A,Ha,C)
\end{tikzpicture}

```

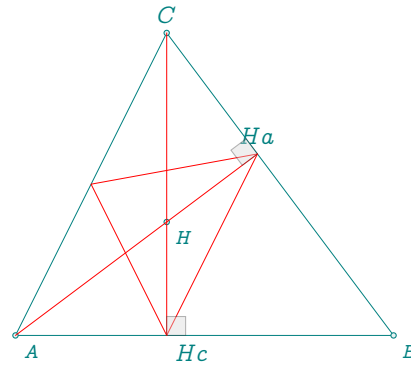

12.3.12 Method bisector

There are several methods to obtain one or more bisectors of a triangle. One possible method is the incentral method. This method allows for defining the incentral triangle whose vertices are the feet of the bisectors from each vertex. If only one bisector is needed, one can use the `bisector(n)` method. The numeric value n can be 0, 1, or 2. By default, if it is absent, it is considered to be 0. Considering the triangle ABC , $n = 0$ means no cyclic permutation of the vertices, and the bisector will be from the first point, here A . If $n = 1$, the point trio BCA is considered, and the bisector will be from B . For $n = 2$, the bisector will be from C .

```

\directlua{%
init_elements ()
  z.A   = point : new ( 0 , 0)
  z.B   = point : new ( 3 , 2)
  z.C   = point : new ( 2 , 5)
  T.ABC = triangle : new ( z.A , z.B , z.C )
  L.AE  = T.ABC : bisector ()
  z.E   = L.AE.pb
  z.F   = T.ABC : bisector (1).pb
  z.a,z.b,z.c = get_points (T.ABC : incentral ())
}
\begin{tikzpicture}
\tkzGetNodes
\tkzDrawPolygon(A,B,C)
\tkzDrawPolygon[red](a,b,c)
\tkzDrawLines(A,B A,C A,E B,F)
\tkzDrawPoints(A,B,C,a,b,c)
\tkzLabelPoints(A,B,c)
\tkzLabelPoints[above](C,b,a)
\tkzMarkAngles[mark=|](B,A,a a,A,C)
\tkzMarkAngles[mark=||](C,B,b b,B,A)
\end{tikzpicture}

```

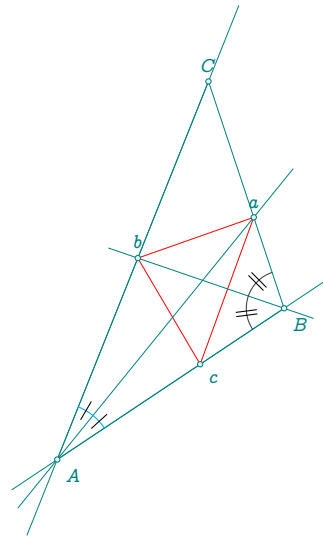

12.3.13 Method euler_circle

The nine-point circle, also called Euler's circle or the Feuerbach circle, is the circle that passes through the perpendicular feet $H_A, H_B,$ and H_C dropped from the vertices of any reference triangle ΔABC on the sides opposite them. Euler showed in 1765 that it also passes through the midpoints M_A, M_B, M_C of the sides of ΔABC . By Feuerbach's theorem, the nine-point circle also passes through the midpoints $E_A, E_B,$ and E_C of the segments that join the vertices and the orthocenter H . These points are commonly referred to as the Euler points. [Weisstein, Eric W. "Nine-Point Circle." From MathWorld—A Wolfram Web Resource.](#)

There are several ways of obtaining the Euler circle. The first would be to use an attribute of the triangle to determine the centre. This centre is defined by $z.N = T.eulercenter$. Next, the circle passes through the midpoint of one of the sides. IF this circle is useful later on, it is best to define it using the `euler_circle` method.

```

\directlua{%
  init_elements ()
  z.A      = point: new (0,0)
  z.B      = point: new (5,0)
  z.C      = point: new (1,4)
  T        = triangle: new(z.A,z.B,z.C)
  C.euler  = T : euler_circle ()
  z.N,z.K  = get_points (C.euler)
}
\begin{tikzpicture}
\tkzGetNodes
\tkzDrawPolygons[red](A,B,C)
\tkzDrawCircle(N,K)
\tkzDrawPoints(A,B,C,N,K)
\tkzLabelPoints(A,B,N)
\tkzLabelPoints[above](C,K)
\end{tikzpicture}

```

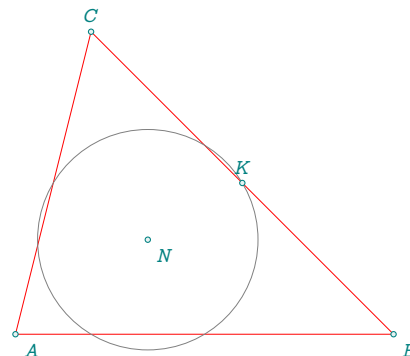

12.3.14 Method circum_circle

To obtain the circumscribed circle, simply use the `T.circumcenter` attribute, but if it is necessary to determine the circle then the method is `circum_circle`.

```

\directlua{%
init_elements ()
  z.A      = point: new (0,0)
  z.B      = point: new (5,0)
  z.C      = point: new (1,4)
  T        = triangle: new(z.A,z.B,z.C)
  C.circum = T : circum_circle ()
  z.O,z.K  = get_points (C.circum)
}
\begin{tikzpicture}
\tkzGetNodes
\tkzDrawPolygons[red](A,B,C)
\tkzDrawCircle(O,K)
\tkzDrawPoints(A,B,C,O,K)
\tkzLabelPoints(A,B,O)
\tkzLabelPoints[above](C,K)
\end{tikzpicture}

```

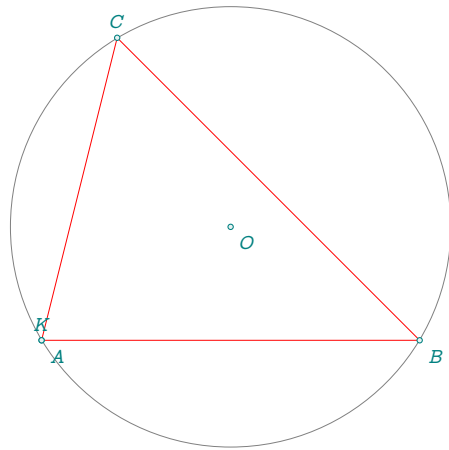

12.3.15 Method `in_circle`

An incircle is an inscribed circle of a polygon, i.e., a circle that is tangent to each of the polygon's sides. The center I of the incircle is called the incenter, and the radius r of the circle is called the inradius.

The incenter is the point of concurrence of the triangle's angle bisectors. In addition, the points M_A , M_B , and M_C of intersection of the incircle with the sides of ABC are the polygon vertices of the pedal triangle [12.3.19] taking the incenter as the pedal point (c.f. tangential triangle [12.3.24]). This triangle is called the contact triangle.

[Weisstein, Eric W. "Incircle." From MathWorld—A Wolfram Web Resource.]

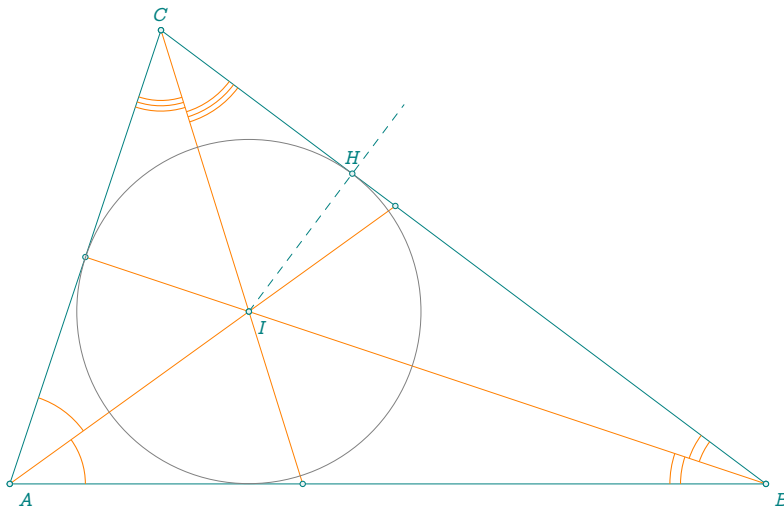

```

\directlua{%
init_elements ()
  z.A    = point : new (0 , 0)
  z.B    = point : new (5 , 0)
  z.C    = point : new (1 , 3)
  T.ABC  = triangle : new(z.A,z.B,z.C)
  z.E    = T.ABC : bisector ().pb
  z.F    = T.ABC : bisector (1).pb
  z.G    = T.ABC : bisector (2).pb
  C.IH   = T.ABC : in_circle ()
  z.I,z.H = get_points (C.IH)
}

\begin{tikzpicture}%
[ new/.style = {color = orange },
  one/.style = { new,/tkzmkangle/size=.5 },
  two/.style = { new,/tkzmkangle/size=.6 },
  l/.style   = { /tkzmkangle/arc=1 },
  ll/.style  = { /tkzmkangle/arc=11 },
  lll/.style = { /tkzmkangle/arc=111 } ]
\tkzGetNodes
\tkzDrawPolygon(A,B,C)
\tkzDrawSegments[new] (A,E B,F C,G)
\tkzDrawSegments[dashed,add=0 and .5] (I,H)
\tkzDrawPoints(A,B,C,E,F,G,I)
\tkzDrawCircle(I,H)
\tkzDrawPoints(I,A,B,C,H)
\begin{scope}[one]
\tkzMarkAngles[1] (B,A,E)
\tkzMarkAngles[11] (C,B,F)
\tkzMarkAngles[111] (A,C,G)
\end{scope}
\begin{scope}[two]
\tkzMarkAngles[1] (E,A,C)
\tkzMarkAngles[11] (F,B,A)
\tkzMarkAngles[111] (G,C,B)
\end{scope}
\tkzLabelPoints(A,B,I)
\tkzLabelPoints[above] (C,H)
\end{tikzpicture}

```

12.3.16 Method `ex_circle`

Given a triangle, extend two sides in the direction opposite their common vertex. The circle tangent to these two lines and to the other side of the triangle is called an excircle, or sometimes an escribed circle. The center of the excircle is called the excenter and lies on the external angle bisector of the opposite angle.

```

\directlua{%
init_elements ()
z.A    = point: new (0 , 0)
z.B    = point: new (5 , 0)
z.C    = point: new (-.4 , 4)
T.ABC  = triangle: new (z.A,z.B,z.C)
z.I,_  = get_points(T.ABC: ex_circle ())
z.J,_  = get_points(T.ABC: ex_circle (1))
z.K,_  = get_points(T.ABC: ex_circle (2))
z.Xk ,
z.Yk ,
z.Zk   = T.ABC : projection (z.K)
z.Xi ,
z.Yi ,
z.Zi   = T.ABC : projection (z.I)
z.Xj ,
z.Yj ,
z.Zj   = T.ABC : projection (z.J)
}

```

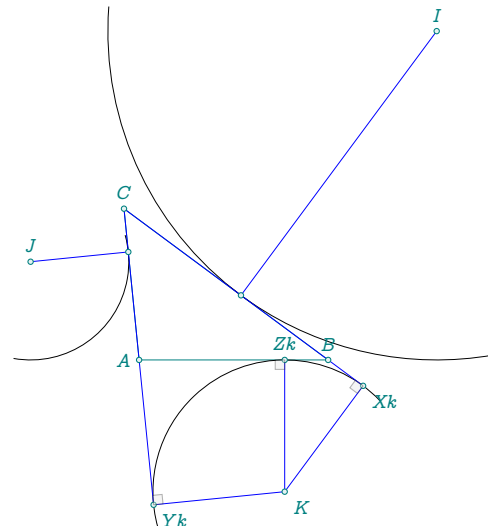

```

\begin{tikzpicture}[scale = .5]
\tkzGetNodes
\tkzDrawPolygon(A,B,C)
\tkzDrawArc(K,Xk)(Yk)
\tkzDrawArc(I,Yi)(Zi)
\tkzDrawArc(J,Zj)(Yj)
\tkzDrawSegments[blue](K,Xk K,Yk K,Zk C,Yk C,Xk I,Xi J,Yj)
\tkzDrawPoints(A,B,C,I,J,K,Xk,Yk,Zk,Xi,Yj)
\tkzLabelPoints(K,Xk,Yk)
\tkzLabelPoints[above](C,B,Zk,I,J)
\tkzLabelPoints[left](A)
\tkzMarkRightAngles[fill=gray!20,opacity=.4](A,Zk,K A,Yk,K K,Xk,B)
\end{tikzpicture}

```

12.3.17 Method spieker_circle

In geometry, the incircle of the medial triangle of a triangle is the Spieker circle. Its center is the Spieker center.

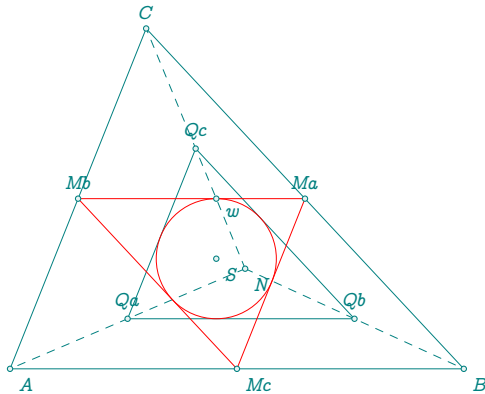

```

\directlua{%
  init_elements ()
  z.A      = point:  new (1,1)
  z.B      = point:  new (5,1)
  z.C      = point:  new (2.2,4)
  T        = triangle: new (z.A,z.B,z.C)
  C.first_lemoine = T:spieker_circle()
  z.S,z.w   = get_points( C.first_lemoine )
  z.Ma,z.Mb,z.Mc = get_points(T : medial ())
  z.N       = T : nagel_point ()
  z.Qa = midpoint(z.A,z.N)
  z.Qb = midpoint(z.B,z.N)
  z.Qc = midpoint(z.C,z.N)
}
\begin{tikzpicture}
\tkzGetNodes
\tkzDrawPolygons(A,B,C Qa,Qb,Qc)
\tkzDrawPolygons[red](Ma,Mb,Mc)
\tkzDrawCircles[red](S,w)
\tkzDrawSegments[dashed](N,A N,B N,C)
\tkzDrawPoints(A,B,C,S,w,Ma,Mb,Mc,Qa,Qb,Qc,N)
\tkzLabelPoints(A,B,S,w,Mc,N)
\tkzLabelPoints[above](C,Ma,Mb,Qa,Qb,Qc)
\end{tikzpicture}

```

12.3.18 Methods cevian and cevian_circle

A Cevian is a line segment which joins a vertex of a triangle with a point on the opposite side (or its extension). The condition for three general Cevians from the three vertices of a triangle to concur is known as Ceva's theorem. Picking a Cevian point P in the interior of a triangle ABC and drawing Cevians from each vertex through P to the opposite side produces a set of three intersecting Cevians APa , BPb , and CPc with respect to that point. The triangle $PaPbPc$ is known as the Cevian triangle of ABC with respect to P , and the circumcircle of $PaPbPc$ is similarly known as the Cevian circle. [Weisstein, Eric W. "Cevian Triangle." From MathWorld—A Wolfram Web Resource.]

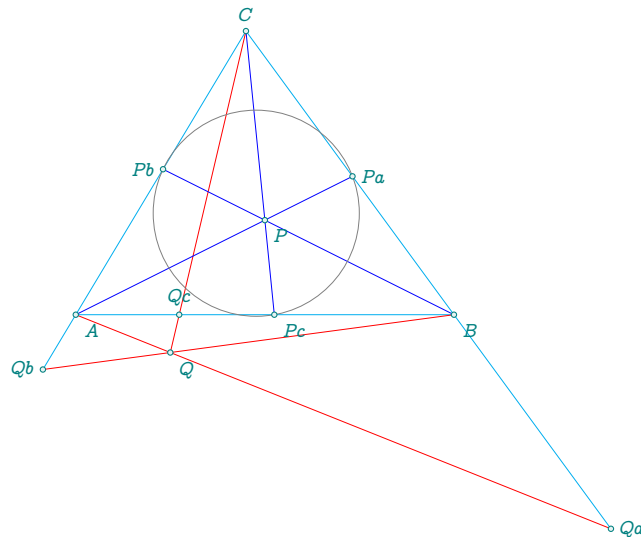

```

\directlua{%
init_elements ()
  z.A      = point: new (0,0)
  z.B      = point: new (4,0)
  z.C      = point: new (1.8,3)
  T.ABC    = triangle: new(z.A,z.B,z.C)
  z.Q      = point : new (1,-0.4)
  z.P      = point : new (2,1)
  T.cevian = T.ABC : cevian (z.Q)
  z.Qa,z.Qb,z.Qc = get_points (T.cevian)
  T.cevian = T.ABC : cevian (z.P)
  z.Pa,z.Pb,z.Pc = get_points (T.cevian)
  C.cev    = T.ABC : cevian_circle (z.P)
  z.w      = C.cev.center
}
\begin{tikzpicture}
\tkzGetNodes
\tkzDrawPolygons[cyan] (A,B,C)
\tkzDrawSegments[cyan] (A,Qb B,Qa)
\tkzDrawSegments[red] (A,Qa B,Qb C,Q)
\tkzDrawSegments[blue] (A,Pa B,Pb C,Pc)
\tkzDrawCircles(w,Pa)
\tkzDrawPoints(A,B,C,Qa,Qb,Qc,P,Q,Pa,Pb,Pc)
\tkzLabelPoints(A,B,P,Q,Pc)
\tkzLabelPoints[above] (C,Qc)
\tkzLabelPoints[left] (Qb,Pb)
\tkzLabelPoints[right] (Qa,Pa)
\end{tikzpicture}

```

12.3.19 Methods `pedal` and `pedal_circle`

Given a point P , the pedal triangle of P is the triangle whose polygon vertices are the feet of the perpendiculars from P to the side lines.

```

\directlua{%
  init_elements ()
  z.A = point: new(0,0)
  z.B = point: new(5,0)
  z.C = point: new(1.5,3)
  z.O = point: new (2,1)
  T.ABC = triangle: new (z.A,z.B,z.C)
  T.pedal = T.ABC : pedal (z.O)
  z.E,z.F,z.G = get_points(T.pedal)
  C.pedal = T.ABC : pedal_circle (z.O)
  z.w = C.pedal.center
  z.T = C.pedal.through
}
\begin{tikzpicture}
\tkzGetNodes
\tkzDrawPolygon(A,B,C)
\tkzDrawPolygon[red](E,F,G)
\tkzDrawCircle(w,T)
\tkzDrawPoints(A,B,C,E,F,G,O)
\tkzLabelPoints(A,B,G)
\tkzLabelPoints[above](C,E,F)
\tkzDrawSegments(O,E O,F O,G)
\end{tikzpicture}

```

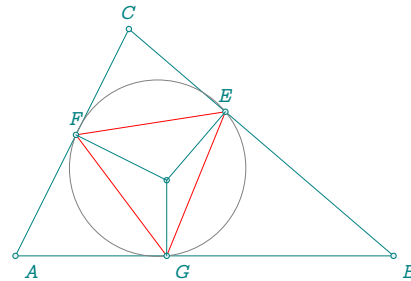

12.3.20 Methods conway_points and conway_circle

In plane geometry, Conway's circle theorem states that when the sides meeting at each vertex of a triangle are extended by the length of the opposite side, the six endpoints of the three resulting line segments lie on a circle whose centre is the centre of incidence of the triangle.

```

\directlua{%
init_elements ()
  z.A = point:new (0,0)
  z.C = point:new (5,0)
  z.B = point:new (1,3)
  T.ABC = triangle : new (z.A,z.B,z.C)
  C.conway = T.ABC : conway_circle ()
  z.w,z.t = get_points(C.conway)
  z.t1,z.t2,z.t3,z.t4,
  z.t5,z.t6= T.ABC : conway_points ()
}
\hspace*{5cm}
\begin{tikzpicture}
\tkzGetNodes
\tkzDrawPolygon(A,B,C)
\tkzDrawCircles(w,t)
\tkzDrawPoints(t1,t2,t3,t4,t5,t6)
\tkzLabelPoints(t1,t2,t3,t4,t5,t6)
\tkzDrawSegments[dashed](t1,A t2,A t3,B)
\tkzDrawSegments[dashed](t4,B t5,C t6,C)
\tkzMarkSegments(B,C t1,A t2,A)
\tkzMarkSegments[mark=||](A,C t3,B t4,B)
\tkzMarkSegments[mark=|||](A,B t5,C t6,C)
\end{tikzpicture}

```

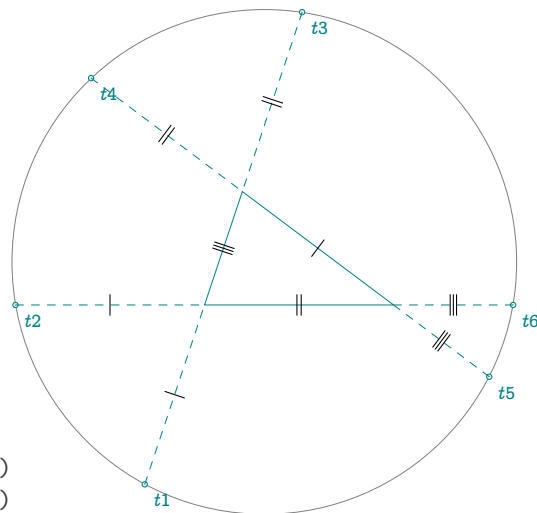

12.3.21 Methods `bevan_circle` and `bevan_point`

```

\directlua{%
  init_elements ()
  z.A      = point: new (1,1)
  z.B      = point: new (6,0)
  z.C      = point: new (2,4)
  T        = triangle: new(z.A,z.B,z.C)
  C.bevan  = T : bevan_circle ()
  z.c,z.t  = get_points (C.bevan)
% or z.c   = T : bevan_point ()
}
\begin{tikzpicture}[scale =.5]
  \tkzGetNodes
  \tkzDrawPolygons(A,B,C)
  \tkzDrawCircle(c,t)
  \tkzDrawPoints(A,B,C,c,t)
  \tkzLabelPoints(A,B,c,t)
  \tkzLabelPoints[above](C)
\end{tikzpicture}

```

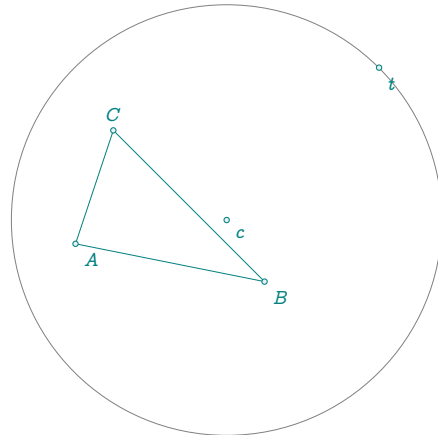
12.3.22 Method `feuerbach` and method `feuerbach_point`

The Feuerbach triangle is the triangle formed by the three points of tangency of the nine-point circle with the excircles. (The fact that the excircles touch the nine-point circle is known as Feuerbach's theorem.) Refer to [Weisstein, Eric W. "Feuerbach Triangle." From MathWorld—A Wolfram Web Resource.](#)

The exinscribed circles of a triangle are tangent to the circle of the nine points of a triangle at points which form the Feuerbach triangle ($FaFbFc$). The inscribed circle and the circle of nine points are tangent at a point called the Feuerbach point F .

```

\directlua{%
init_elements ()
z.A      = point: new (0,0)
z.B      = point: new (6,0)
z.C      = point: new (0.8,4)
T.ABC    = triangle : new ( z.A,z.B,z.C )
z.N      = T.ABC.eulercenter
z.Fa,z.Fb,z.Fc = get_points ( T.ABC : feuerbach () )
z.F      = T.ABC : feuerbach_point ()
z.Ja,z.Jb,z.Jc = get_points ( T.ABC : excentral () )
z.I      = T.ABC.incenter
z.Ia,z.Ib,z.Ic = get_points (T.ABC : intouch ())
}
\begin{tikzpicture}[ scale = .8]
\tkzGetNodes
\tkzDrawPoints(Ja,Jb,Jc)
\tkzClipBB
\tkzFillCircles[green!30,,opacity=.5](N,Fa)
\tkzFillCircles[lightgray,,opacity=.5](I,F)
\tkzDrawLines[add=3 and 3](A,B A,C B,C)
\tkzDrawCircles(Ja,Fa Jb,Fb Jc,Fc N,Fa N,F I,F)
\tkzDrawPoints(A,B,C,F,Fa,Fb,Fc,N,I,Ia,Ib,Ic)
\tkzLabelPoints(N,A,B,Ia,Ib,Ic)
\tkzLabelPoints[above](Fa,Fb,Fc,F,I,C)
\end{tikzpicture}

```

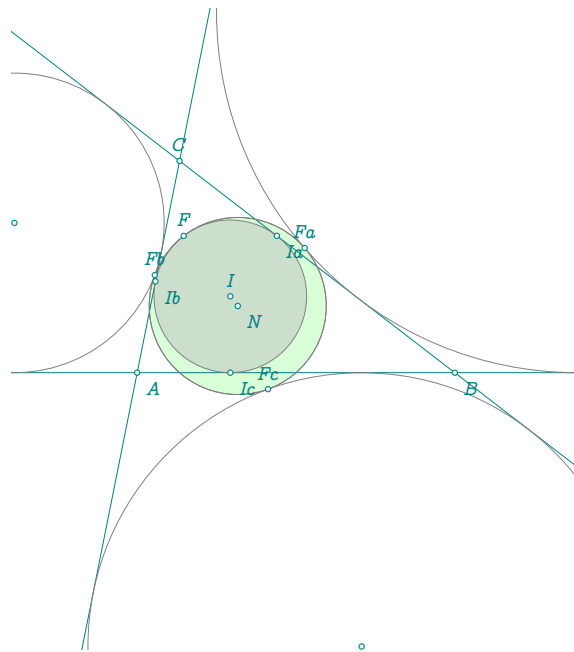

12.3.23 Method similar

The similar method creates a new triangle whose sides are parallel to the sides of the original triangle and pass through its vertices.

```
\directlua{%
  init_elements ()
  z.A          = point: new (0 , 0)
  z.B          = point: new (6 , 0)
  z.C          = point: new (1.5 , 3.5)
  T.ABC       = triangle: new (z.A,z.B,z.C)
  z.X,z.Y,z.Z = get_points ( T.ABC : similar ())
  z.H_a,z.H_b, = get_points (T.ABC : orthic ())
  z.H_c
}
\begin{tikzpicture}[ scale =.5]
  \tkzGetNodes
  \tkzDrawPolygons(A,B,C X,Y,Z)
  \tkzDrawLines(A,H_a B,H_b C,H_c)
  \tkzDrawPoints(A,B,C,X,Y,Z)
  \tkzLabelPoints(A,B,Z)
  \tkzLabelPoints[above](X,Y,C)
\end{tikzpicture}
```

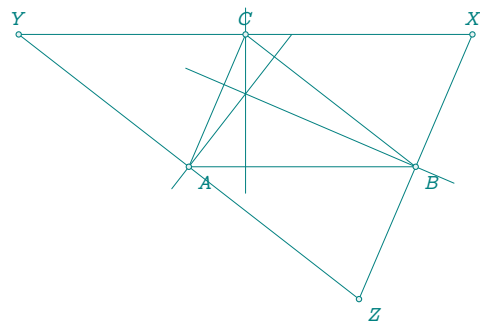

12.3.24 Method medial

The triangle $MaMbMc$ formed by joining the midpoints of the sides of a triangle ABC . The medial triangle is sometimes also called the auxiliary triangle (Dixon 1991). [Weisstein, Eric W. "Medial Triangle." From MathWorld—A Wolfram Web Resource.]

```

\directlua{%
  init_elements ()
  z.A      = point: new (0,1)
  z.B      = point: new (6,0)
  z.C      = point: new (2,4)
  T        = triangle: new(z.A,z.B,z.C)
  T.med    = T : medial ()
  z.Ma,z.Mb,z.Mc= get_points (T.med)
  z.G      = T.centroid
  z.O      = T.circumcenter
}
\begin{tikzpicture}[scale = 1.25]
\tkzGetNodes
\tkzDrawPolygons(A,B,C)
\tkzDrawPolygons[red](Ma,Mb,Mc)
\tkzDrawSegments(A,Ma B,Mb C,Mc)
\tkzDrawSegments[dashed,cyan](O,Ma O,Mb O,Mc)
\tkzDrawPoints(A,B,C,Ma,Mb,Mc,O,G)
\tkzLabelPoints(A,B,Mc,O)
\tkzLabelPoints[above](C)
\tkzLabelPoints[left](Mb)
\tkzLabelPoints[right](Ma,G)
\tkzMarkRightAngles[fill=cyan!20,
  opacity=.4](O,Ma,B O,Mb,A O,Mc,A)
\end{tikzpicture}

```

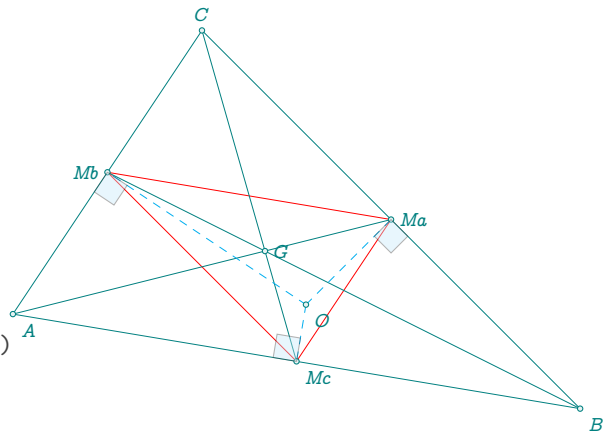

12.3.25 Method incentral

The incentral triangle $IaIbIc$ is the Cevian triangle of a triangle ABC with respect to its incenter I . It is therefore also the triangle whose vertices are determined by the intersections of the reference triangle's angle bisectors with the respective opposite sides. [Weisstein, Eric W. "Incentral Triangle." From MathWorld—A Wolfram Web Resource.]

```

\directlua{%
  init_elements ()
  z.A      = point: new (0 , 0)
  z.B      = point: new (6 , 0)
  z.C      = point: new (1 , 4)
  T.ABC    = triangle: new (z.A,z.B,z.C)
  z.I      = T.ABC.incenter
  z.Ia,z.Ib,
  z.Ic     = get_points (T.ABC : incentral ())
  z.Ta,z.Tb,
  z.Tc     = get_points (T.ABC : intouch ())
}
\begin{tikzpicture}
\tkzGetNodes
\tkzDrawPolygon(A,B,C)
\tkzDrawPolygon[dashed,red](Ia,Ib,Ic)
\tkzDrawSegments[dashed,red](A,Ia B,Ib C,Ic)
\tkzDrawCircle(I,Ta)
\tkzDrawPoints(A,B,C,Ia,Ib,Ic,I,Ta,Tb,Tc)
\tkzLabelPoints(A,B,Ic,I,Tc)
\tkzLabelPoints[above](Ia,Ta,C)
\tkzLabelPoints[above left](Ib,Tb)
\end{tikzpicture}

```

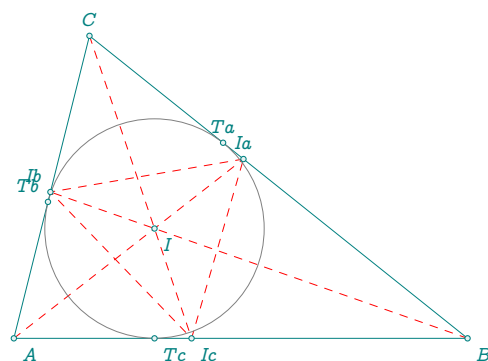

12.3.26 Method tangential

The tangential triangle is the triangle $T_aT_bT_c$ formed by the lines tangent to the circumcircle of a given triangle ΔABC at its vertices. It is therefore antipedal triangle of ABC with respect to the circumcenter O . It is also anticevian triangle of ABC with the symmedian point K as the anticevian point (Kimberling 1998, p. 156). Furthermore, the symmedian point K of ABC is the Gergonne point of $T_aT_bT_c$.

The sides of an orthic triangle are parallel to the tangents to the circumcircle at the vertices (Johnson 1929, p. 172). This is equivalent to the statement that each line from a triangle's circumcenter to a vertex is always perpendicular to the corresponding side of the orthic triangle (Honsberger 1995, p. 22), and to the fact that the orthic and tangential triangles are homothetic. [Weisstein, Eric W. "Tangential Triangle." From MathWorld—A Wolfram Web Resource.]

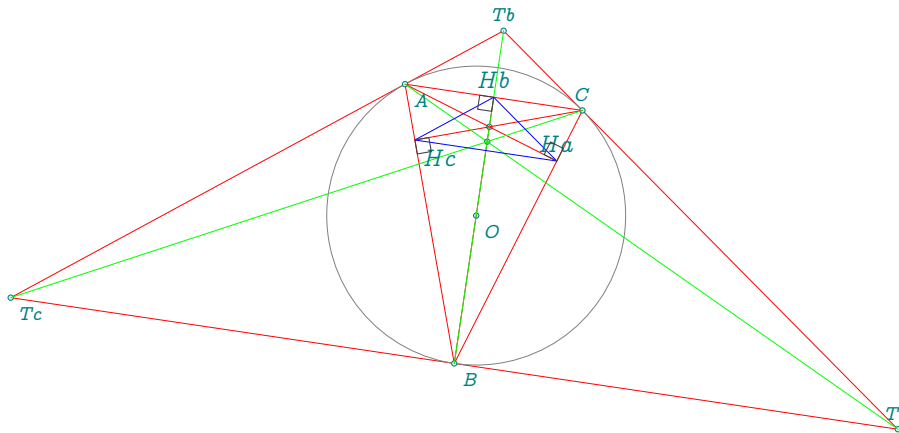

```
\directlua{%
init_elements ()
  z.A      = point: new (0,0)
  z.B      = point: new (5,0)
  z.C      = point: new (1,3)
  T        = triangle: new(z.A,z.B,z.C)
  z.H      = T.orthocenter
  z.O      = T.circumcenter
  z.L      = T : symmedian_point ()
  T.orthic = T: orthic()
  z.Ha,
  z.Hb,
  z.Hc     = get_points (T.orthic)
  z.Ta,
  z.Tb,
  z.Tc     = get_points (T : tangential ())
}
\begin{tikzpicture}[scale= .75]
\tkzGetNodes
\tkzDrawPolygons[red] (A,B,C Ta,Tb,Tc)
\tkzDrawCircle(O,A)
\tkzDrawPoints(A,B,C,O,H,Ta,Tb,Tc,L)
\tkzDrawSegments[red] (C,Hc B,Hb A,Ha)
\tkzDrawSegments[green] (C,Tc B,Tb A,Ta)
\tkzDrawPolygon[blue] (Ha,Hb,Hc)
\tkzLabelPoints(A,B,O,Tc)
\tkzLabelPoints[above] (C,Tb,Ta)
\tkzLabelPoints[font=\small] (Hc)
\tkzLabelPoints[font=\small,above] (Ha,Hb)
```

```
\tkzMarkRightAngles(A,Ha,C B,Hb,A C,Hc,B)
\end{tikzpicture}
```

12.3.27 Method `symmedial`

The `symmedial` triangle $L_aL_bL_c$ is the triangle whose vertices are the intersection points of the symmedians with the reference triangle ABC .

The `symmedial` circle is the circumcircle of the `symmedial` triangle.

The following example groups several concepts around the `symmedian`. As a reminder, a `symmedian` of a triangle is the reflection of the median with respect to the angle bisector.

The points of contact of the `symmedians` with the sides of the triangle are obtained using the `symmedian` method. The intersection of the `symmedians` is the point known as the Lemoine or `Symmedian` point. You can use the triangle methods `lemoine_point` or `symmedian_point`. If you only need one of the lines, you can use the method `symmedian_line(n)`. $n = 0$ corresponds to the line coming from the first vertex of the triangle, $n = 1$ to the second, and so on.

In the next example, L is the Lemoine point or the `Symmedian` point. $L_aL_bL_c$ is the `symmedian` triangle. [Weinstein, Eric W. "Symmedian Point." From MathWorld—A Wolfram Web Resource.]

```
\directlua{%
  init_elements ()
  z.A          = point :   new (0,0)
  z.B          = point :   new (7,0)
  z.C          = point :   new (2,3)
  T.ABC       = triangle : new (z.A,z.B,z.C)
  z.L         = T.ABC : lemoine_point ()
  T.SY        = T.ABC : symmedian ()
  T.med       = T.ABC : medial ()
  z.Ka,z.Kb,z.Kc = get_points (T.SY)
  z.Ma,z.Mb,z.Mc = get_points (T.med)
  L.Kb        = T.ABC : symmedian_line (1)
  _,z.Kb      = get_points(L.Kb)
  z.G         = T.ABC.centroid
  z.Ia,z.Ib,z.Ic = get_points ( T.ABC : incentral ())
  %          z.T = T.ABC : trilinear (0,1,1)
  z.I         = T.ABC.incenter
}
\begin{tikzpicture}[ scale = 2]
\tkzGetNodes
\tkzDrawPolygons(A,B,C)
\tkzDrawPoints(A,B,C,L,Ka,Kb,Kc,G,Ma,Mb,Mc,Ia,Ib,Ic,I)
\tkzDrawSegments[cyan](A,Ka B,Kb C,Kc)
\tkzDrawSegments[green](A,Ma B,Mb C,Mc)
\tkzDrawSegments[dashed,red](A,Ia B,Ib C,Ic)
\tkzLabelPoints[above](C,Ka,Ia,Ma)
\tkzLabelPoints[above left](Kb,Ib,Mb)
\tkzLabelPoints(A,B,L,Kc,I,Ic,Mc,G)
\end{tikzpicture}
```

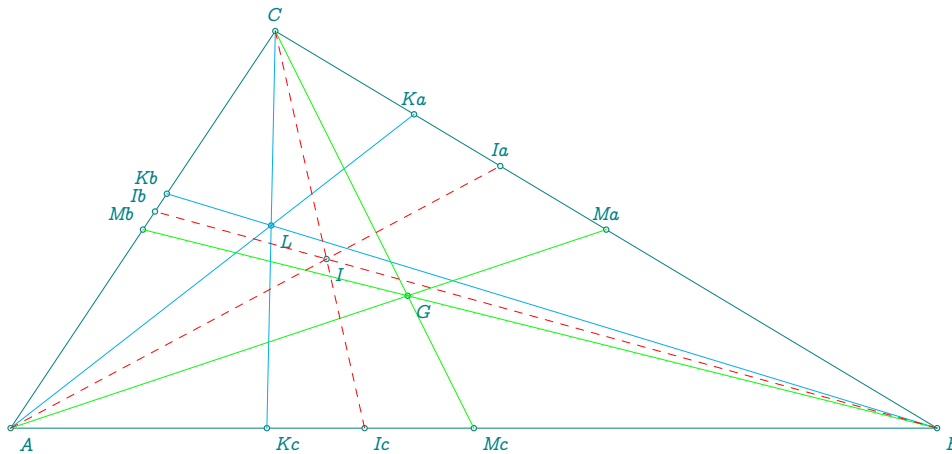

12.3.28 Method anti

The anticomplementary triangle is the triangle $T_aT_bT_c$ which has a given triangle ABC as its medial triangle. It is therefore the anticevian triangle with respect to the triangle centroid G (Kimberling 1998, p. 156). [Weisstein, Eric W. "Anticomplementary Triangle." From MathWorld—A Wolfram Web Resource.]

```
\directlua{%
init_elements ()
  z.A      = point: new (0,0)
  z.B      = point: new (5,0)
  z.C      = point: new (2,4)
  T        = triangle: new(z.A,z.B,z.C)
  T.similar = T: anti()
  z.Ta,
  z.Tb,
  z.Tc     = get_points (T.similar)
}
\begin{tikzpicture}[scale = .6]
\tkzGetNodes
\tkzDrawPolygons[red](A,B,C)
\tkzDrawPolygon[blue](Ta,Tb,Tc)
\tkzDrawPoints(A,B,C,Ta,Tb,Tc)
\tkzLabelPoints(A,B,Tc)
\tkzLabelPoints[above](Ta,Tb,C)
\end{tikzpicture}
```

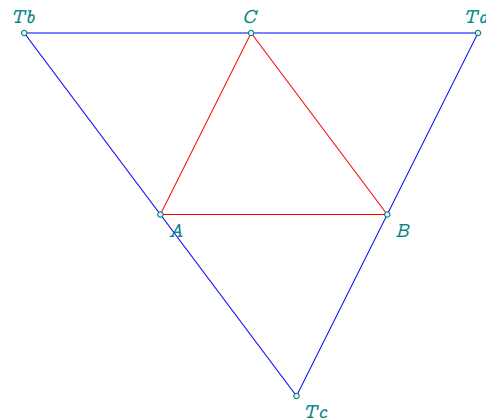

12.3.29 Methods euler_line and orthic_axis

Let h_a , h_b and h_c be the vertices of the orthic triangle of a triangle ABC . Then each side of each triangle meets the three sides of the other triangle, and the points of intersection lie on a line Q_cQ_b called the orthic axis of ABC . It is perpendicular to the Euler line. The `orthic_axis` method returns a straight line, i.e. only two points. To obtain the third point, use the `orthic_axis_points` method.

The line on which the orthocenter H , triangle centroid G , circumcenter O , nine-point center N , and a number of other important triangle centers lie. [Weisstein, Eric W. "Euler Line." From MathWorld—A Wolfram Web Resource.]

```
\directlua{
init_elements ()
  z.B      = point: new (0,0)
  z.C      = point: new (5,0)
  z.A      = point: new (.6,3)
  T        = triangle: new(z.A,z.B,z.C)
  z.N      = T.eulercenter
}
```

```

z.H      = T.orthocenter
z.O      = T.circumcenter
z.G      = T.centroid
z.ha,z.hb,z.hc = get_points (T : orthic ())
L.orthic = T : orthic_axis ()
z.Qa,z.Qb,z.Qc = T : orthic_axis_points ()
L.euler  = T : euler_line ()
z.ea,z.eb = get_points (L.euler)
z.K      = L.orthic : projection (z.N)
}
\begin{tikzpicture}
\tkzGetNodes
\tkzDrawPolygons[cyan](A,B,C)
\tkzDrawLines[red](Qc,Qb)
\tkzDrawSegments(A,Qc B,Qa A,ha B,hb C,hc C,Qb)
\tkzDrawSegments[dashed](hb,Qc hb,Qa ha,Qb)
\tkzDrawLines[blue, add = .5 and .5](ea,eb)
\tkzDrawPoints(A,B,C,ha,hb,hc)
\tkzDrawPoints(N,H,O,G,Qa,Qb,Qc)
\tkzLabelPoints(N,H,O,G)
\tkzLabelPoints(B,C,ha)
\tkzLabelPoints[above right](A,hb)
\tkzLabelPoints[left](hc,Qa,Qb,Qc)
\tkzMarkRightAngle(N,K,Qb)
\tkzLabelSegment[sloped,blue,pos=1.4,above](ea,eb){\small\texttt{euler\_line}}
\tkzLabelSegment[sloped,red,pos=.8](Qc,Qb){\small\texttt{orthic\_axis}}
\end{tikzpicture}

```

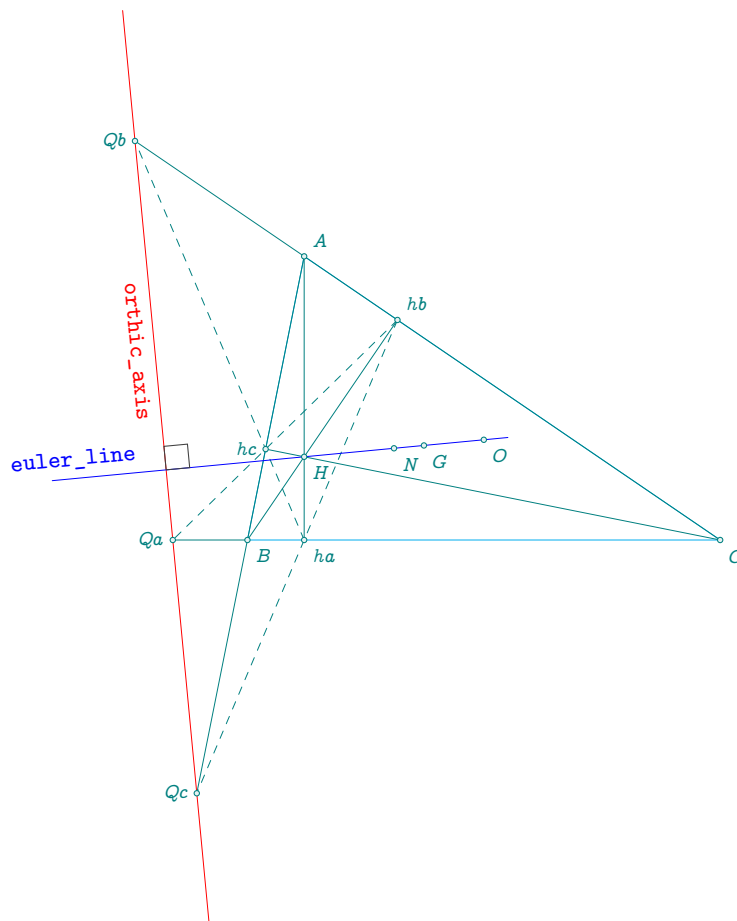

12.3.30 Euler ellipse

The Euler ellipse is a conic, tangent to the three sides of a triangle, with the orthocentre and the centre of the circumscribed circle as foci. Example of obtaining the Euler circle as well as the Euler ellipse.

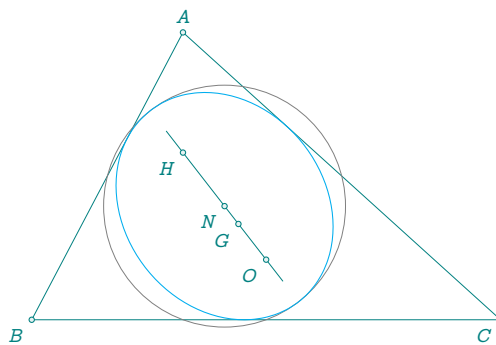

```
\directlua{%
init_elements ()
z.A      = point: new (2,3.8)
z.B      = point: new (0 ,0)
z.C      = point: new (6.2 ,0)
L.AB     = line : new ( z.A , z.B )
T.ABC    = triangle: new (z.A,z.B,z.C)
z.K      = midpoint (z.B,z.C)
EL.euler = T.ABC : euler_ellipse ()
```

```

curve      = EL.euler : points (0,1,50)
z.N        = T.ABC.eulercenter
C.euler    = circle : new (z.N,z.K)
z.O        = T.ABC.circumcenter
z.G        = T.ABC.centroid
z.H        = T.ABC.orthocenter
}
\begin{tikzpicture}
\tkzGetNodes
\tkzDrawPolygon(A,B,C)
\tkzDrawCircle(N,K)
\tkzDrawCoordinates[smooth,cyan](curve)
\tkzDrawLine(O,H)
\tkzDrawPoints(A,B,C,N,O,H,G)
\tkzLabelPoints[below left](B,C,N,O,H,G)
\tkzLabelPoints[above](A)
\end{tikzpicture}

```

12.3.31 Steiner inellipse and circumellipse

In this example, the inner and outer Steiner ellipses, referred to as the "inellipse" and "circumellipse" [Weisstein, Eric W. "Steiner Inellipse." From *MathWorld—A Wolfram Web Resource*. and Weisstein, Eric W. "Steiner Circumellipse." From *MathWorld—A Wolfram Web Resource*.], respectively, along with the orthoptic circle, are depicted. The triangle must be acutangle.

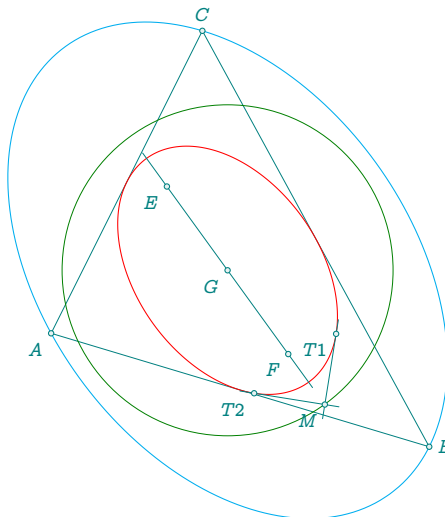

```

\directlua{
z.A      = point: new (1 , 4)
z.B      = point: new (11 , 1)
z.C      = point: new (5 , 12)
T.ABC    = triangle: new(z.A,z.B,z.C)
EL_a     = T.ABC: steiner_inellipse ()
curve_a  = EL_a : points (0,1,100)
z.G      = EL_a.center
ang      = math.deg(EL_a.slope)
z.F      = EL_a.Fa
z.E      = EL_a.Fb
C        = EL_a: orthoptic ()
}

```

```

z.w      = C.center
z.o      = C.through
EL_b     = T.ABC : steiner_circumellipse ()
curve_b  = EL_b : points (0,1,100)
z.M      = C : point (0)
L.T1,
L.T2     = EL_a : tangent_from (z.M)
z.T1     = L.T1.pb
z.T2     = L.T2.pb
}
\begin{tikzpicture}[scale =.5]
\tkzGetNodes
\tkzDrawPolygon(A,B,C)
\tkzDrawCircles[black!50!green](w,o)
\tkzDrawCoordinates[smooth,red](curve_a)
\tkzDrawCoordinates[smooth,cyan](curve_b)
\tkzDrawLines(F,E M,T1 M,T2)
\tkzDrawPoints(A,B,C,F,E,G,M,T1,T2)
\tkzLabelPoints[above](C)
\tkzLabelPoints[right](B)
\tkzLabelPoints[below left](A,F,E,G,T1,T2,M)
\end{tikzpicture}

```

```

\begin{tikzpicture}[scale =.5]
\tkzGetNodes
\tkzDrawPolygon(A,B,C)
\tkzDrawCircles[black!50!green](w,o)
\tkzDrawCoordinates[smooth,red](curve_a)
\tkzDrawCoordinates[smooth,cyan](curve_b)
\tkzDrawLines(F,E M,T1 M,T2)
\tkzDrawPoints(A,B,C,F,E,G,M,T1,T2)
\tkzLabelPoints[above](C)
\tkzLabelPoints[right](B)
\tkzLabelPoints[below left](A,F,E,G,T1,T2,M)
\end{tikzpicture}

```

12.3.32 Harmonic division and bisector

Let four points A, C, B and D , in this order, lying on the straight line (d) and M un point pris hors de (d) . Then, if two of the following three propositions are true, then the third is also true:

1. The division $(A,B;C,D)$ is harmonic. $(CA/CB = DA/DB)$
2. (MC) is the internal angle bisector of \widehat{AMB} .
3. $(MD) \perp (MC)$.

```

\directlua{
init_elements ()
  z.A      = point: new (0 , 0)
  z.B      = point: new (6 , 0)
  z.M      = point: new (5 , 4)
  T.AMB    = triangle : new (z.A,z.M,z.B)
  L.AB     = T.AMB.ca
  L.bis    = T.AMB : bisector (1)
  z.C      = L.bis.pb
  L.bisext = T.AMB : bisector_ext (1)
  z.D      = intersection (L.bisext,L.AB)
  L.CD     = line: new (z.C,z.D)
  z.O      = L.CD.mid
  L.AM     = line: new (z.A,z.M)
  L.LL     = L.AM : ll_from (z.B)
  L.MC     = line: new (z.M,z.C)
  L.MD     = line: new (z.M,z.D)
  z.E      = intersection (L.LL,L.MC)
  z.F      = intersection (L.LL,L.MD)
}

```

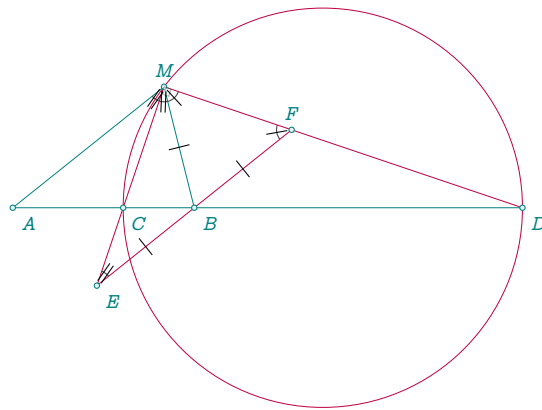

```

\begin{tikzpicture}[scale =.4]
  \tkzGetNodes
  \tkzDrawPolygon(A,B,M)
  \tkzDrawCircle[purple](O,C)
  \tkzDrawSegments[purple](M,E M,D E,F)
  \tkzDrawSegments(D,B)
  \tkzDrawPoints(A,B,M,C,D,E,F)
  \tkzLabelPoints[below right](A,B,C,D,E)
  \tkzLabelPoints[above](M,F)
  \tkzMarkRightAngle[opacity=.4,fill=gray!20](C,M,D)
  \tkzMarkAngles[mark=||,size=.5](A,M,E E,M,B B,E,M)
  \tkzMarkAngles[mark=|,size=.5](B,M,F M,F,B)
  \tkzMarkSegments(B,E B,M B,F)
\end{tikzpicture}

```

12.3.33 Method c_ll_p

See [10.2.31] for special cases. Please note that the arguments are not the same as for the line class. We are looking for a circle tangent to two straight lines passing through a point

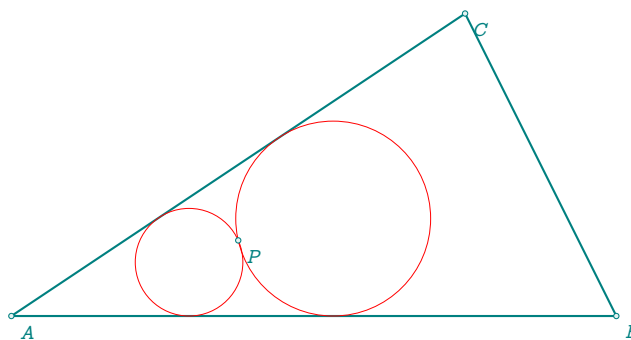

```

\directlua{
init_elements()
  z.A = point : new ( 0 , 0 )
  z.B = point : new ( 8 , 0 )

```

```

L.AB = line : new ( z.A,z.B )
z.C = point : new ( 6 , 4 )
L.AC = line : new ( z.A,z.C )
T = triangle : new (z.A,z.B,z.C)
z.P = point : new ( 3 , 1 )
C1,C2 = T : c_ll_p (z.P)
z.O1 = C1.center
z.T1 = C1.through
z.O2 = C2.center
z.T2 = C2.through
}
\begin{tikzpicture}
\tkzGetNodes
\tkzDrawLines[thick](A,B A,C B,C)
\tkzDrawCircles[red](O1,T1 O2,T2)
\tkzDrawPoints(A,B,C,P)
\tkzLabelPoints(A,B,C,P)
\end{tikzpicture}

```

12.3.34 Method `steiner_line`

Let ABC be a triangle with orthocenter H . M is a point on the circumcircle of the triangle ABC .

Let H_A, H_B , and H_C be the reflections of M in three lines BC, AC and AB respectively.

P_A, P_B, P_C , and H are collinear. The line is known as the Steiner line of point M with respect to the triangle ABC .

Whatever the point M , the Steiner line associated with M passes through the orthocenter H of triangle ABC .

M lies on the circumscribed circle of the triangle if and only if P, Q and R are aligned.

```

\directlua{
z.B = point: new (0,0)
z.C = point: new (4,0)
z.A = point : new (1,4)
T.ABC = triangle: new(z.A,z.B,z.C)
C.ABC = T.ABC : circum_circle ()
z.O = T.ABC.circumcenter
z.H = T.ABC.orthocenter
z.M = C.ABC : point (.65)
z.H_P = T.ABC.ab : reflection (z.M)
z.H_Q = T.ABC.bc : reflection (z.M)
z.H_R = T.ABC.ca : reflection (z.M)
L.steiner = T.ABC : steiner_line (z.M)
z.P = T.ABC.ab : projection (z.M)
z.Q = T.ABC.bc : projection (z.M)
z.R = T.ABC.ca : projection (z.M)
}
\begin{tikzpicture}
\tkzGetNodes
\tkzDrawLines[cyan,add= .5 and .5](A,C A,B B,C)
\tkzDrawLines[red,thick](H_P,H_Q)
\tkzDrawCircles(O,A)
\tkzDrawPoints(A,B,C,M,H_P,H_Q,H_R,O,H,P,Q,R)
\tkzLabelPoints(B,C,H_P,H_Q,H_R,R)
\tkzLabelPoints[above](O,H)
\tkzLabelPoints[above right](P,Q,A,M)
\tkzDrawSegments(M,H_P M,H_Q M,H_R)
\tkzMarkRightAngles(B,P,M M,R,A M,Q,B)
\end{tikzpicture}

```

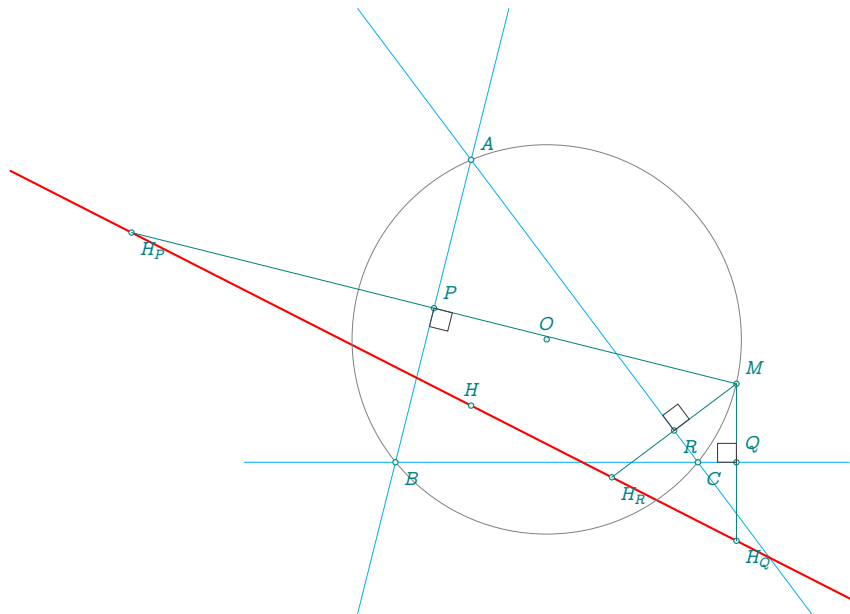

12.3.35 Method `simson_line`

The Simson line is the line containing the feet P , Q , and R of the perpendiculars from an arbitrary point M on the circumcircle of a triangle to the sides or their extensions of the triangle.

[Jackson, Frank and Weisstein, Eric W. "Simson Line." From MathWorld—A Wolfram Web Resource.]

```

\directlua{
  z.B          = point: new (0,0)
  z.C          = point: new (4,0)
  z.A          = point : new (1,4)
  T.ABC        = triangle: new(z.A,z.B,z.C)
  C.ABC        = T.ABC : circum_circle ()
  z.O          = T.ABC.circumcenter
  z.H          = T.ABC.orthocenter
  z.M          = C.ABC : point (.65)
  z.H_P        = T.ABC.ab : reflection (z.M)
  z.H_Q        = T.ABC.bc : reflection (z.M)
  z.H_R        = T.ABC.ca : reflection (z.M)
  L.steiner    = T.ABC : steiner_line (z.M)
  z.P          = T.ABC.ab : projection (z.M)
  z.Q          = T.ABC.bc : projection (z.M)
  z.R          = T.ABC.ca : projection (z.M)
  L.simson     = T.ABC : simson_line (z.M)
  z.sa,z.sb   = get_points(L.simson)
}
\begin{tikzpicture}
\tkzGetNodes
\tkzDrawLines[cyan,add= .5 and .5](A,C A,B B,C)
\tkzDrawLines[red,thick](H_P,H_Q)
\tkzDrawLines[blue,thick](sa,sb)
\tkzDrawCircles(O,A)
\tkzDrawPoints(A,B,C,M,H_P,H_Q,H_R,O,H,P,Q,R)
\tkzLabelPoints(B,C,H_P,H_Q,H_R,R)
\tkzLabelPoints[above](O,H)
\tkzLabelPoints[above right](P,Q,A,M)
\tkzDrawSegments(M,H_P M,H_Q M,H_R)

```

```
\tkzMarkRightAngles(B,P,M M,R,A M,Q,B)
\end{tikzpicture}
```

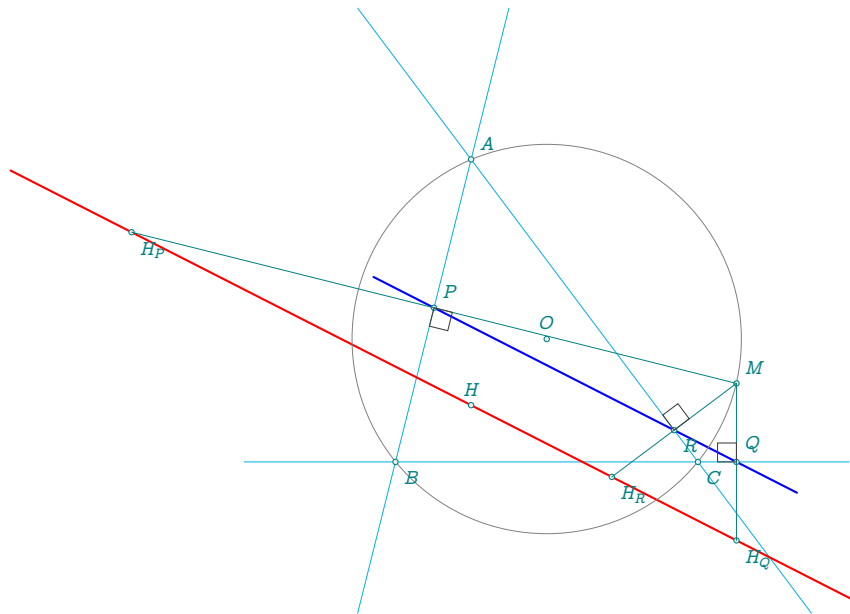

12.3.36 Method lemoine_axis

Tangents to the circumcircle at the vertex are antiparallel to the opposite side. When extended, the intersections of the tangents and the opposite sides intersect in collinear points. This line is called the Lemoine Axis.

The Lemoine axis of the triangle is the polar of the Lemoine point with respect to the circumscribed circle of the triangle. On this line also lie the three centers of the Apollonius circles, corresponding to the triplets (A, B, CA/CB), (B, C, AB/AC), (C, A, BC/BA).

```
\directlua{
  z.A = point: new (0,0)
  z.B = point: new (5,1)
  z.C = point: new (1,2)
  T = triangle: new(z.A,z.B,z.C)
  z.L = T : lemoine_point ()
  z.O = T.circumcenter
  L.L = T : lemoine_axis ()
  z.la,
  z.lb = get_points (L.L)
  L.B = T : brocard_axis ()
  z.ba,
  z.bb = get_points (L.B)}
\begin{tikzpicture}
\tkzGetNodes
\tkzDrawPolygons[cyan](A,B,C)
\tkzDrawLines[purple,add = 1 and 1](la,lb)
\tkzDrawLines[red,add = 1 and 1](ba,bb)
\tkzDrawCircle(O,A)
\tkzDrawPoints(A,B,L,O,la,lb)
\tkzLabelPoints(A,B,L,O)
\tkzLabelPoints[above](C)
\tkzLabelLine[sloped,above,purple](la,lb){Lemoine\_axis}
\tkzLabelLine[sloped,above,red](ba,bb){Brocard\_line}
\end{tikzpicture}
```

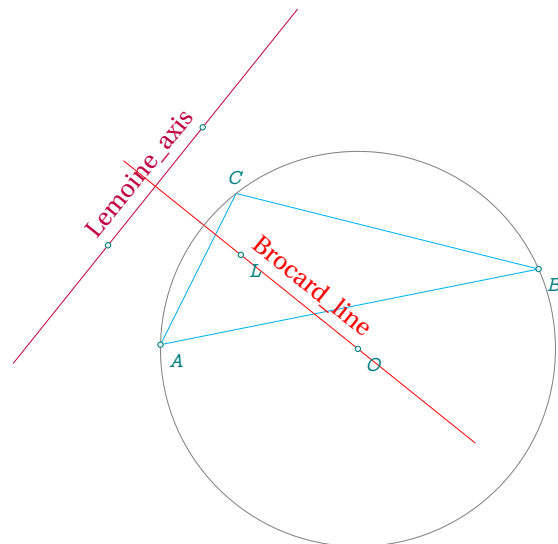

12.3.37 Method brocard_axis

The Brocard axis is the line KO passing through the symmedian point K and circumcenter O of a triangle, where the segment OK is the Brocard diameter (Kimberling 1998, p. 150). The Brocard axis is perpendicular to the Lemoine axis and is the isogonal conjugate of the Kiepert hyperbola. [Weisstein, Eric W. "Brocard Axis." From [MathWorld—A Wolfram Web Resource.](#)]

Refer to [12.3.36]

12.3.38 Method fermat_axis

The Fermat axis is the line connecting the first and second Fermat points.

```
\directlua{
  z.A      = point :   new (1,2)
  z.B      = point :   new (5,1)
  z.C      = point :   new (2.5,3)
  T.ABC    = triangle : new (z.A,z.B,z.C)
  z.F1     = T.ABC : first_fermat_point ()
  z.F2     = T.ABC : second_fermat_point ()
  L.F      = T.ABC : fermat_axis ()
  z.a, z.b = get_points(L.F)
  z.L      = T.ABC : lemoine_point ()}
```

```
\begin{tikzpicture}
  \tkzGetNodes
  \tkzDrawPolygon(A,B,C)
  \tkzDrawLine(a,b)
  \tkzDrawPoints(A,B,C)
  \tkzDrawPoints(F1,F2,L)
  \tkzLabelPoints[right] (B,F1,F2,L)
  \tkzLabelPoints[above] (C)
  \tkzLabelPoints(A)
\end{tikzpicture}
```

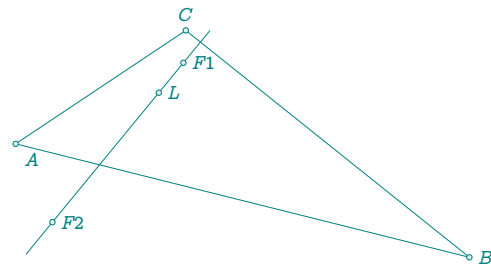

12.3.39 Method taylor_circle

The six projections of the feet of the heights of a triangle onto the adjacent sides are cocyclic.

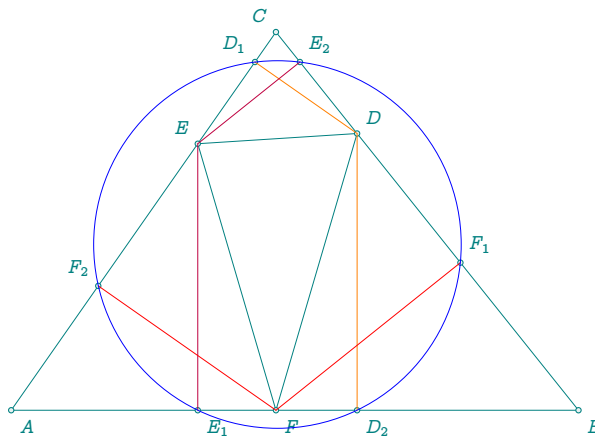

```
\directlua{
  init_elements ()
  z.A      = point :   new (0,0)
  z.B      = point :   new (6,0)
  z.C      = point :   new (2.8,4)
  T.ABC    = triangle: new (z.A,z.B,z.C)}
```

```

T.DEF      = T.ABC : orthic ()
z.D,z.E,z.F = get_points (T.DEF)
z.D_1,
z.D_2,
z.E_1,
z.E_2,
z.F_1,
z.F_2      = T.ABC :taylor_points ()
C.taylor   = T.ABC :taylor_circle ()
z.w,z.t    = get_points (C.taylor )
}
\begin{tikzpicture}
  \tkzGetNodes
  \tkzDrawPolygons(A,B,C D,E,F)
  \tkzDrawPoints(A,B,...,F,D_1,D_2,E_1,E_2,F_1,F_2)
  \tkzLabelPoints(A,B,F,E_1,D_2)
  \tkzLabelPoints[above left](F_2,E,C,D_1)
  \tkzLabelPoints[above right](E_2,D,F_1)
  \tkzDrawSegments[orange](D,D_1 D,D_2)
  \tkzDrawSegments[purple](E,E_1 E,E_2)
  \tkzDrawSegments[red](F,F_1 F,F_2)
  \tkzDrawCircles[blue](w,t)
\end{tikzpicture}

```

12.3.40 Method isogonal

The isogonal conjugate y of a point x in the plane of the triangle ABC is constructed by reflecting the lines Ax , Bx , and Cx about the angle bisectors at A , B , and C . The three reflected lines then concur at the isogonal conjugate y . The isogonal conjugate can be obtained in another way. It is the center of the circle passing through the three points obtained by reflection of the x point with respect to the triangle's three sides. This is the method I used. To verify that my method is correct, I obtained the circumcenter as the isogonal conjugate of the orthocenter. A point M being chosen on the circumcircle, the isogonal conjugates of the points on the tangent to the circle at M trace a parabola passing through the vertices of the triangle. One difficulty is the chaotic order in which these conjugates move along the parabola. The intersection points of the sides with the tangent are the conjugates of the triangle's vertices. Points near M move toward infinity.

```

\directlua{
  z.a = point: new (0 , 0)
  z.b = point: new (4 , 0)
  z.c = point: new (1 , 4)
  T.abc = triangle : new (z.a,z.b,z.c)
  z.H = T.abc.orthocenter
  z.O = T.abc : isogonal (z.H)
  z.I = T.abc.incenter
  C = circle : new (z.O,z.a)
  z.M = C : point (0.45)
  Ta = C :tangent_at (z.M)
  z.u = Ta.pb
  z.v = Ta.pa
  z.x = intersection (Ta,T.abc.ca)
  z.y = T.abc : isogonal (z.x)
  points = {}
  for t = 1.5, 50, 1/10 do
    local x = Ta : point (t)
    local y = T.abc : isogonal (x)
    table.insert (points, ("..checknumber(y.re)..", "..checknumber(y.im).."))
  end
}

```

```

end
for t = -55, 0.2, 1/10 do
  local x = Ta : point (t)
  local y = T.abc : isogonal (x)
  table.insert (points, "("..checknumber(y.re)..","..checknumber(y.im)..")")
end
}
\begin{tikzpicture}
  \tkzGetNodes
  \tkzDrawPolygon(a,b,c)
  \tkzDrawCoordinates[smooth,red,thick](points)
  \tkzDrawLines[add =.25 and .25](x,v a,b b,c a,x)
  \tkzDrawPoints(a,b,c,H,M,x,y,H,O)
  \tkzLabelPoints(a,b,M,H,O)
  \tkzLabelPoints[above](c,x,y)
  \tkzDrawCircles(O,a)
\end{tikzpicture}

```

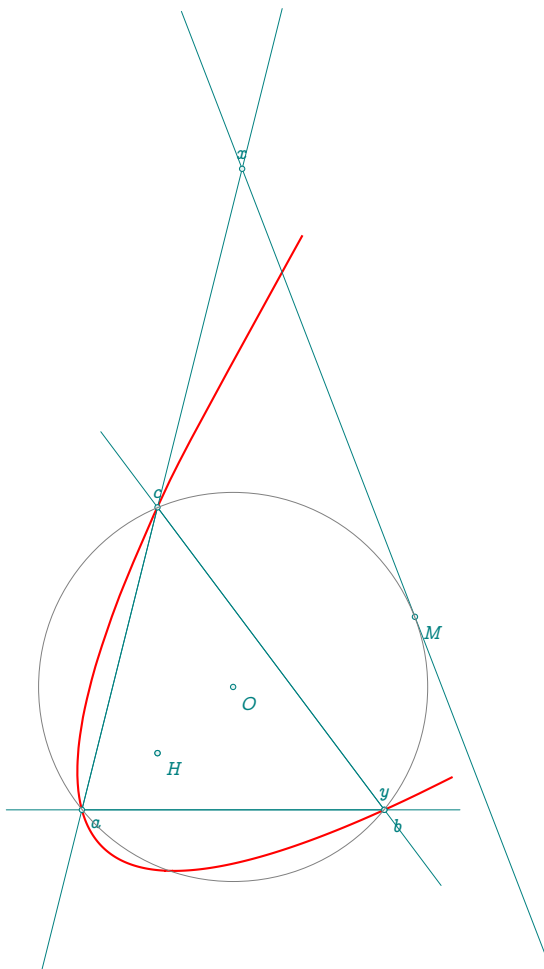

13 Class conic

13.1 Preamble

To illustrate the different methods used to draw conics, here's how you can obtain a parabola. In the following example, the parabola is the locus of all circle centers tangent to a given circle.

The `points` table contains the coordinates of the centers of the identified circles. `TikZonly` requires a list of coordinate pairs enclosed in brackets. The table that defines the circles is slightly more complex. It contains the centers and the tangency points between the circles and the given elements. These are sequences of four coordinates, stored in the table. Finally, the sequences are concatenated into a string using a comma (",") as the separator. Coordinates are read with the `\foreach` macro, utilizing the `expand list` option.

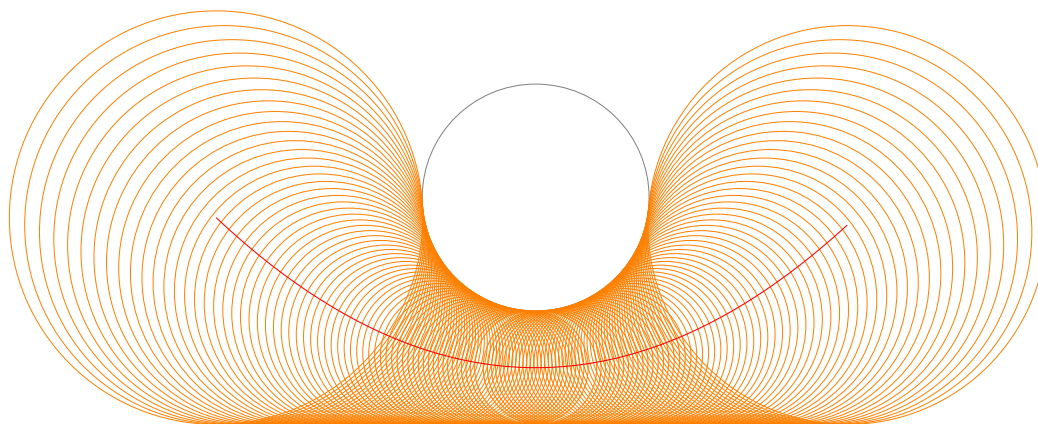

Here's the code. Two lists are created, one containing the points of the parabola, the other the points that define the tangent circles. The parabola is obtained using TikZ's ability to draw a curve from a list of coordinates. To obtain the circles, note the use of the `expand list` option in the `\foreach` loop.

```
\directlua{
z.O = point : new (0,0)
z.P = point : new (0,6)
z.M = point : new (0,3)
z.I = point : new (1,0)
C.PM = circle : new (z.P,z.M)
list = {}
points = {}
for t = -0.24, 0.24, 0.004 do
if (t> - 0.002 and t< 0.002) then else
z.A = C.PM : point (t)
L.OI = line : new (z.O,z.I)
L.PA = line : new (z.P,z.A)
z.C = intersection (L.OI,L.PA)
L.tgt = C.PM : tangent_at (z.A)
z.X = intersection (L.tgt,L.OI)
z.o = bisector (z.X,z.A,z.C).pb
table.insert (points, ("..z.o.re..","..z.o.im.."))
table.insert (list,z.o.re.."/"..z.o.im.."/"..z.A.re.."/"..z.A.im)
end
end
list = table.concat(list,",")
}

\begin{tikzpicture}[scale =.75]
\tkzGetNodes
\tkzDrawCircle(P,M)
```



```

\foreach[expand list] \r/\s/\u/\v in {\directlua{tex.print({list})}}
{
  \tkzDefPoint(\u,\v){A}
  \tkzDefPoint(\r,\s){o}
  \tkzDrawCircle[orange](o,A)
}
\tkzDrawCoordinates[smooth,red](points)
\end{tikzpicture}

```

This class replaces the one dedicated to ellipses. From now on, you can work with parabolas, hyperbolas and ellipses. The circle is not part of this class. As you'll see from the examples, ellipses used to be built by TikZ, now conics are obtained by point-by-point construction. A cloud of points is sent to TikZ, which simply connects them.

```
plot[<local options>]coordinates{<coordinate 1><coordinate 2>...<coordinate n>}
```

is used by the macro `\tkzDrawCoordinates`. One advantage of this method is that you can easily draw only part of a conic.

13.2 Attributes of a conic

Parabolas, hyperbolas and ellipses share many attributes, but some exist only for the last two conics. I previously defined ellipses using three points (center, vertex, and covertex), but from now on, conics will be defined using a focus, a directrix, and an eccentricity. Of course, the old method can still be used. I've created a few little conversion tools to get the focus, the director and the eccentricity right in some cases.

The first attributes are used to define the conic: `Fa` (focus), `directrix` (directrix) and `e` (eccentricity).

Table 11: Conic attributes.

Attributes	Application
Fa	main foyer of the conic
directrix	directrix of the conic
major_axis	Axis through focal points
minor_axis	Axis through focal points
e	eccentricity of the conic
type	The type is 'conic'
subtype	'parabola', 'hyperbola' or 'ellipse'
a	Only for hyperbola and ellipse
b	Only for hyperbola and ellipse
c	Only for hyperbola and ellipse
p	semi latus rectum
slope	Slope of the line passes through the foci
K	Projection of the focus onto the directrix
Fb	Second focus for hyperbola and ellipse
vertex	main vertex
covertex	
Rx	Radius from center to vertex
Ry	Radius from center to covertex

13.2.1 About attributes of conic

The figure below and the associated table show common attributes and differences according to exentricity values.

```

\directlua{
  init_elements ()
  z.A = point : new ( 0 , 0 )
  z.B = point : new ( 4 , -2 )
  L.dir = line : new (z.A,z.B)
  z.F = point : new ( 2 , 2 )
  C01 = conic : new(z.F,L.dir,.8)
  C02 = conic : new(z.F,L.dir, 1)
  C03 = conic : new(z.F,L.dir, 1.2)
  curve1 = C01 : points (0,1, 40)
  curve2 = C02 : points (-5,5,40)
  curve3 = C03 : points (-5,5,40)
  z.K = C01.K
  z.u,z.v = get_points(C01.major_axis)
  z.x = L.dir : report (-4,z.K)
  z.y = L.dir : report ( 4,z.K)
  z.r = (z.F-z.K) : orthogonal (-4) : at (z.F)
  z.s = (z.F-z.K) : orthogonal (4) : at (z.F)
  L.rs = line : new (z.r,z.s)
  z.I_1 = intersection (L.rs,C01)
  z.I_2 = intersection (L.rs,C02)
  z.I_3,_ = intersection (L.rs,C03)
  z.H_1 = C01.directrix : projection (z.I_1)
  z.H_2 = C02.directrix : projection (z.I_2)
  z.H_3 = C03.directrix : projection (z.I_3)
  z.S_2 = C02.vertex
  z.F_1 = C01.Fb
  z.C_1 = C01.center
  z.C_3 = C03.center
}

```

The focus F , the line directrix and the value of $h = KF$ are attributes common to all three conics. These conics differ in their eccentricity e , here 0.8 for the ellipse, 1 for the parabola and 1.2 for the hyperbola. The semi latus rectum p is equal to $e * h$ and differs depending on the conic. It is represented by FI_1 , FI_2 and FI_3 . By definition, $e = \frac{p}{h}$

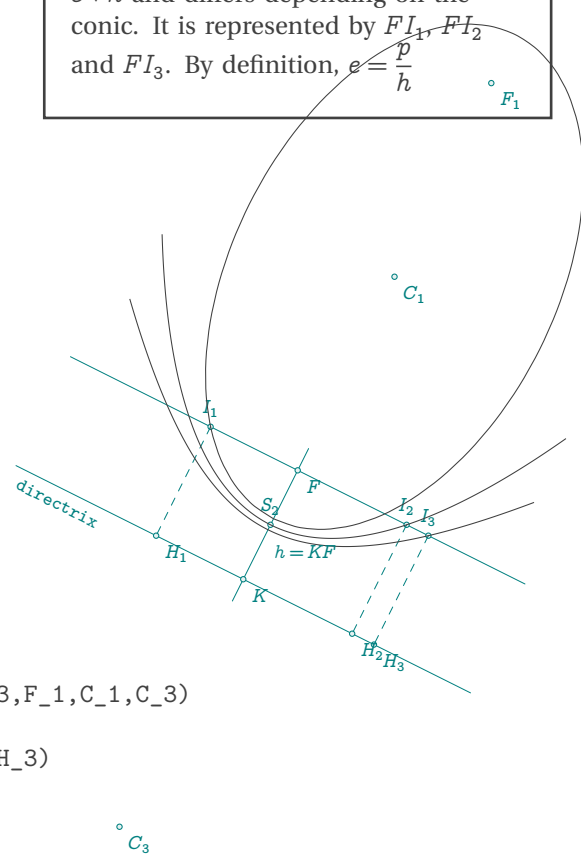

```

\begin{tikzpicture}
\tkzGetNodes
\tkzDrawLines(x,y u,v r,s)
\tkzDrawPoints(F,K,I_1,I_2,I_3,S_2,H_1,H_2,H_3,F_1,C_1,C_3)
\tkzLabelPoints(F,K,H_1,H_2,H_3,F_1,C_1,C_3)
\tkzDrawSegments[dashed](I_1,H_1 I_2,H_2 I_3,H_3)
\tkzLabelPoints[above](I_1,I_2,I_3,S_2)
\tkzDrawCoordinates[smooth](curve1)
\tkzDrawCoordinates[smooth](curve2)
\tkzDrawCoordinates[smooth](curve3)
\tkzLabelSegment[pos=.4](K,F){$h = KF$}
\tkzLabelSegment[sloped,pos=-.2](x,y){\texttt{directrix}}
\end{tikzpicture}

```

13.2.2 Attributes of parabola

Let

```
PA = conic : new (z.F, L.AB, 1)
```

The focus is F , it is given if we use another definition by $PA.Fa$. The eccentricity of a parabola is always 1. It has only one focus, unlike the hyperbola and ellipse. The parabola has no center and only one directrix. The parabola can be distinguished from other conics by its eccentricity, of course, but also by subtype. Thus $PA.subtype = 'parabola'$.

The projection of F onto the directrix is the point K , which is given by $PA.K$.

p , the semi latus rectum, is always given by $e \cdot h$, so here $p = h$.

Like other conics, the parabola has a vertex given by $PA \cdot vertex$, but no covertex. The vertex is the middle of the segment KF .

It can be seen that if we choose a reference frame with origin S , the parabola has an equation of the style $y = \frac{x^2}{2p}$.

For conics, the values a , b , c represent distances from the center, so they don't exist for the parabola.

The last two attributes are common to all conics. They are the axis passing through the focus F and its projected line K on the directrix. This line is obtained with $PA \cdot major_axis$. You can also use the angle between this axis and the horizontal with $PA \cdot slope$. The main axis is oriented from K to F .

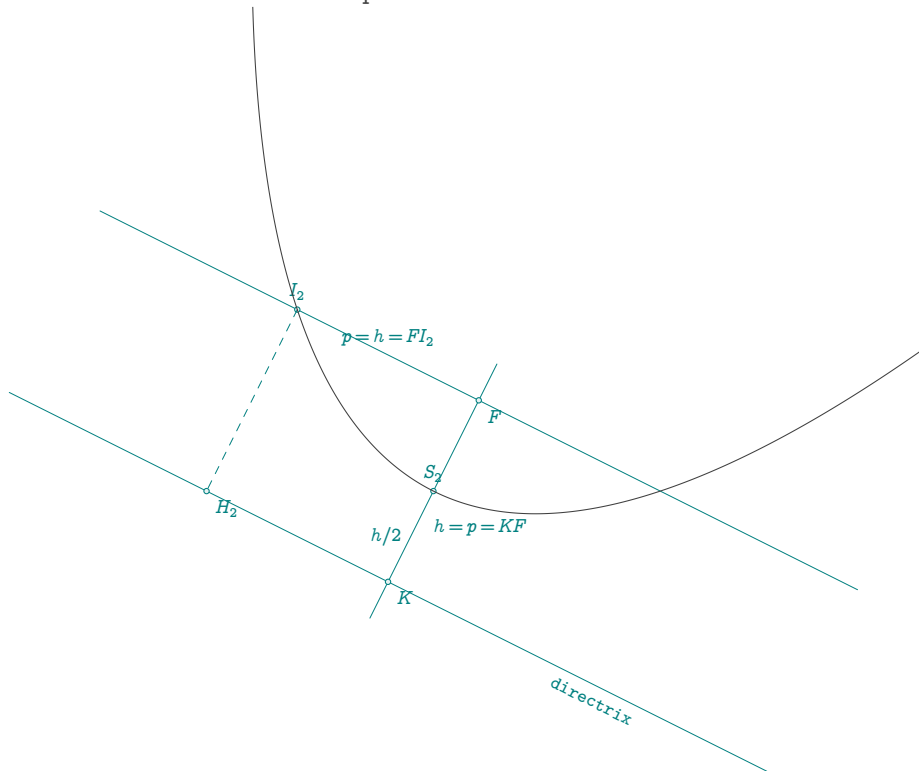

13.2.3 Attributes of hyperbola

Let

```
HY = conic : new (z.F, L.AB, 1.2)
```

This time, the eccentricity is greater than 1. The common attributes have already been mentioned. Specific attributes include second focus ($HY \cdot Fb$) and center ($HY \cdot center$).

It's possible to use different measures of the segments that characterize the hyperbola. $CS = a$ the distance between center and vertex is obtained with ($HY \cdot a$). $CF = c$ the distance between center and focus is obtained with ($HY \cdot c$).

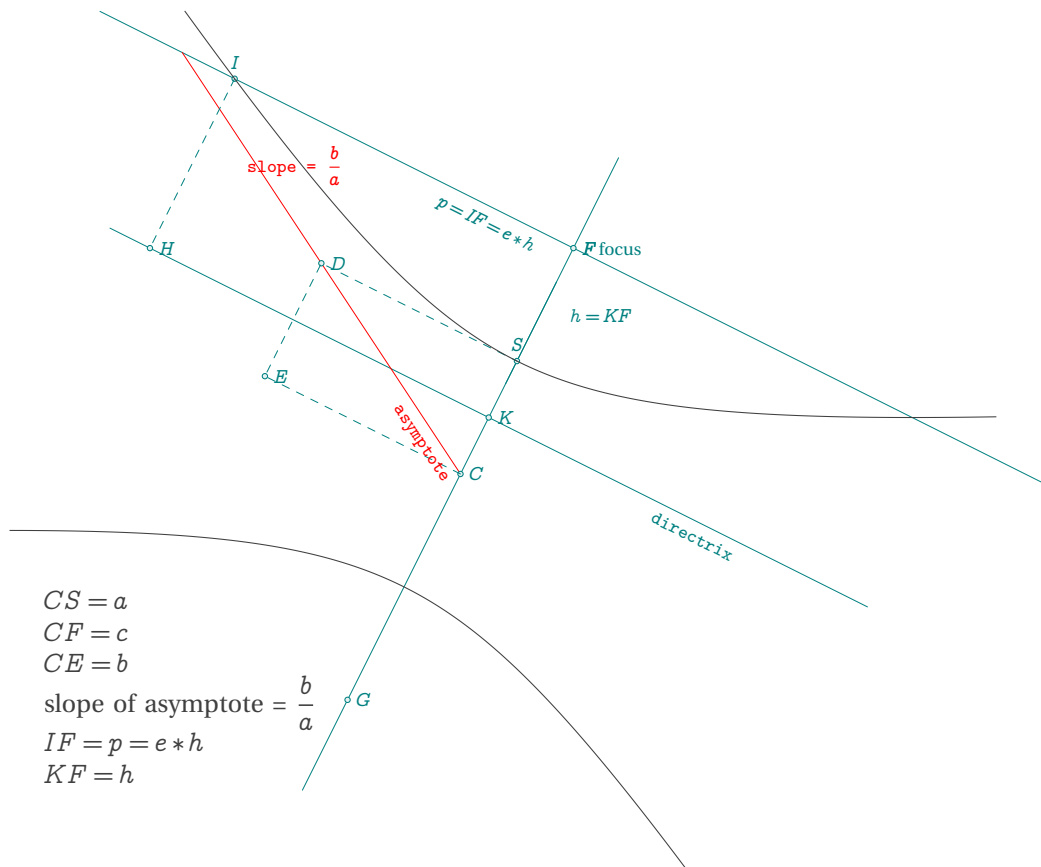

13.2.4 Attributs of ellipse

We find the same attributs as for the hyperbola. The relationships between the measures change: while for the hyperbola we have $c = \sqrt{a^2 + b^2}$, for the ellipse $c = \sqrt{a^2 - b^2}$.

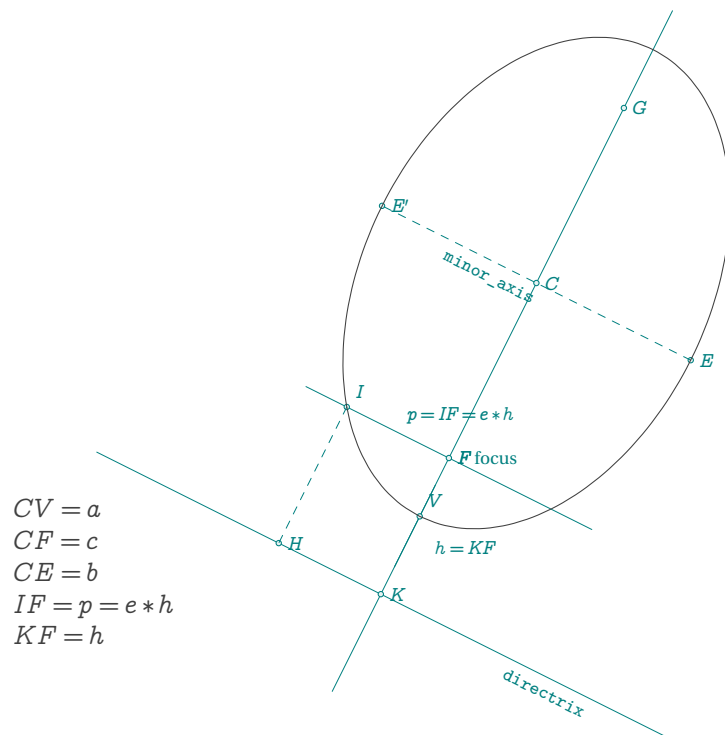

13.3 Point-by-point conic construction

13.4 Parabola construction

The method is based on the following observation: if a point M belongs to the parabola, then the bisector of the segment from the focus to the projection of H from M onto the directrix is also the bisector of the angle \widehat{HFT} and the tangent to the parabola at the point M .

This is the method I chose to construct the set of points representing the parabola.

```

\directlua{
z.A      = point : new ( 0 , 1 )
z.B      = point : new ( 4 , 3 )
z.F      = point : new ( 2 , 6 )
L.AB     = line  : new (z.A,z.B)
PA       = conic : new (z.F,L.AB,1)
z.K      = PA.K
z.M      = PA : point(-2)
z.H      = PA.directrix : projection (z.M)
L.FH     = line  : new (z.F,z.H)
L.med    = L.FH : mediator ( )
L.orth   = PA.directrix : ortho_from (z.H)
z.T      = intersection (L.AB,L.med)
curve    = PA : points (-5,5,50)
z.m      = midpoint(z.H,z.F)
}
\begin{tikzpicture}
\tikzGetNodes
\tikzDrawCoordinates[smooth](curve)
\tikzDrawLines[add = .5 and .5](A,B M,T K,F)
\tikzDrawSegments(M,H H,F F,M)
\tikzDrawPoints(F,K,T,M,H)
\tikzLabelPoints(F,K,T,M,H)
\tikzMarkAngles[mark=|](H,M,T T,M,F)
\tikzMarkSegments[mark=|](H,M M,F)
\tikzMarkSegments[mark=|](H,m m,F)
\end{tikzpicture}

```

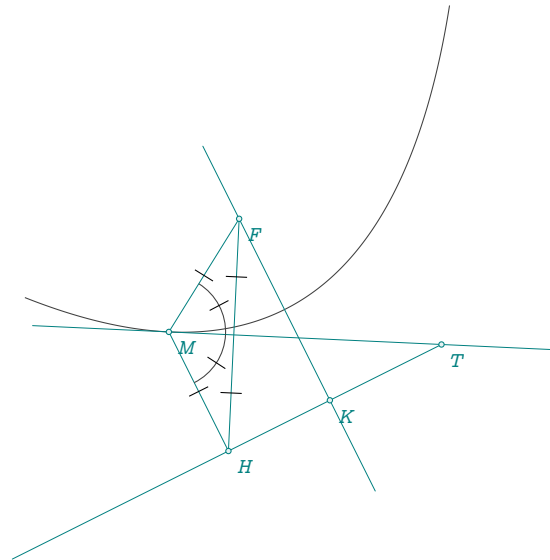

13.5 Hyperbola construction

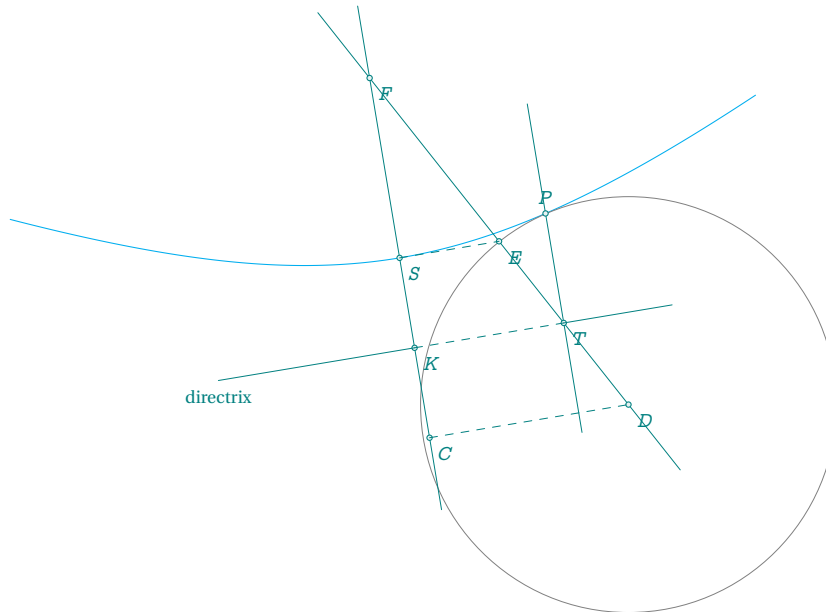

```

\directlua{
z.A = point : new (-2, -1)
z.B = point : new ( 4,  0)
L.AB = line : new (z.A,z.B)
z.F = point : new (0,3)
HY = conic : new (z.F,L.AB,2)
curve = HY : points (-5,5,50)
z.K = HY.K
z.S = HY.vertex
z.O = HY.center
z.X = HY : point(2)
z.T = HY.directrix : report (2,HY.K)
LT = HY.major_axis : ll_from (z.T)
z.u,z.v = get_points(LT)
LC = HY.minor_axis
LS = LC : ll_from (HY.vertex)
z.D = intersection_ll_ (LC.pa,LC.pb,HY.Fa,z.T)
z.E = intersection_ll_ (LS.pa,LS.pb,HY.Fa,z.T)
z.P,z.Q = intersection_lc_ (LT.pa,LT.pb,z.D,z.E)
z.C = HY.center
}
\begin{tikzpicture}
\tkzGetNodes
\tkzDrawCoordinates[smooth,cyan](curve)
\tkzDrawCircle(D,E)
\tkzDrawLines(F,C F,D)
\tkzDrawLines[add = 1 and 1](T,P)
\tkzDrawPoints(C,F,K,S,T,P,D,E)
\tkzLabelPoints(C,F,K,S,T,D,E)
\tkzLabelPoint[below,sloped](A){directrix}
\tkzLabelPoints[above](P)
\tkzDrawSegments(A,K T,B)
\tkzDrawSegments[dashed](S,E K,T C,D)
\end{tikzpicture}

```

13.6 Ellipse construction

The point-by-point construction is obtained by transforming the principal circle through an affinity with the focal axis as its axis, parallel to the directrix, with a ratio of b/a . Let H be the projection of the point Q onto the focal axis. With $OA = a$ and $OB = b$, it is then sufficient to draw a parallel to (AB) passing through Q , which intersects the focal axis at T , yielding $\frac{b}{a} = \frac{HT}{HQ}$. Now, since $HT = HQ'$, we obtain $\frac{HQ'}{HQ} = \frac{b}{a}$.

```

\directlua{
init_elements ()
z.Fb = point: new ( 3 , 0 )
z.Fa = point: new ( -3 , 2 )
local c = length(z.Fa,z.Fb)/2
local a = 4
local b = math.sqrt(a^2 -c^2)
local e = c/a
L.focal = line : new (z.Fa,z.Fb)
z.O = L.focal.mid
z.K = report_(z.O,z.Fb,a^2/c)
z.Ko = ortho_from_(z.K,z.K,z.Fb)
L.dir = line :new(z.K,z.Ko)
EL = conic : new (z.Fb,L.dir,e)
curve = EL : points (0,1,100)
z.V = EL.vertex
local C = circle : new (z.O,EL.vertex)
z.A = C : point(0.25)
z.B = L.focal : report (-EL.b,z.O)
z.Q = C : point(.2)
z.H = L.focal : projection (z.Q)
z.Qp = L.focal : affinity (L.focal
: ortho_from(z.O),b/a,z.Q)
z.T = intersection_ll_ (z.Q,
ll_from_ (z.Q,z.A,z.B),z.Fb,z.Fa)
}
\begin{tikzpicture}
\tkzGetNodes
\tkzDrawCoordinates[smooth](curve)
\tkzDrawLines(Fa,Fb K,Ko)
\tkzDrawLines[add = 2 and 2](K,Ko)
\tkzDrawSegments[dashed](H,Q O,A)
\tkzDrawCircles(O,Q H,T)
\tkzDrawPoints(Fa,Fb,Q,Q',H,V,A,B,O)
\tkzLabelPoints(Fa,Fb,Q,Q',H,V,A,B,O)
\tkzDrawSegments[red](A,B Q,T)
\end{tikzpicture}

```

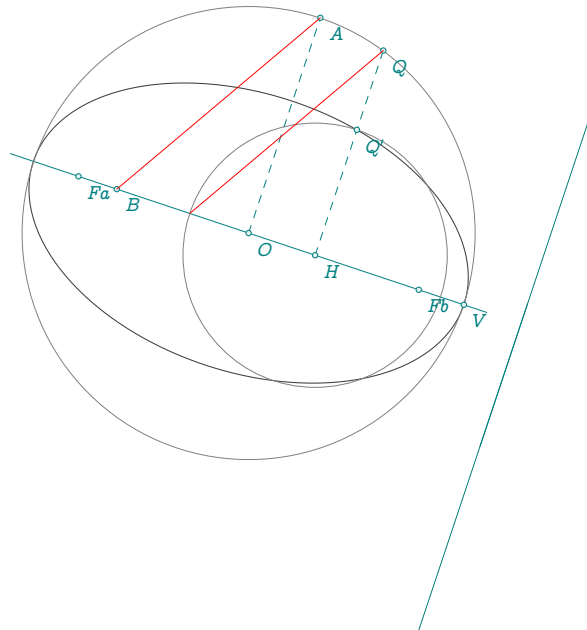

13.7 Methods of the class conic

The methods previously designed for the (now obsolete) `ellipse` class have been generalized to the `conic` class. The most natural creation method is now the one based on a focus, a directrix, and the eccentricity.

```
CO = conic : new (z.F,L.dir,e)
```

Depending on the latter, it is easy to distinguish between parabolas, hyperbolas, and ellipses. The bifocal definition of hyperbolas and ellipses is also available, as well as the one based on three points: the center, a vertex,

and a covertex.

Table 12: Conic methods.

Methods	Example
<code>new (pt, L , e)</code>	<code>CO = conic: new (focus, directrix, eccentricity)</code>
<code>points (ta,tb,nb,swap)</code>	swap to get the second part of hyperbola
<code>point (t)</code>	to get one point on the curve
<code>in_out (pt)</code>	pt in/out of the conic
<code>tangent_at (pt)</code>	tangent at point on the curve
<code>tangent_from (pt)</code>	
<code>orthoptic_curve()</code>	

13.7.1 Method points

This method generates a set of points that belong to the conic. This set is then passed to `tkz-euclide`, which, using TikZ's `draw[options] plot coordinates`, will plot the curve. The method requires three arguments: the minimum value of t , the maximum value of t , and the number of points between these two values.

```
CO = conic : new (z.F,L.dir,e)
curve = CO : points (ta,tb,nb)
```

All that remains is to use the macro `\tkzDrawCoordinates`

```
\tkzDrawCoordinates [smooth,red] (curve)
```

13.7.2 Method points with parabola

t is the abscissa of a point on the parabola, in an orthonormal frame of reference with origin K and based on the directrix line and focal axis (major_axis).

```
\directlua{
init_elements ()
z.A = point : new (-2, -1)
z.B = point : new ( 4, 0)
z.F = point : new ( 1 , 3 )
L.dir = line : new (z.A,z.B)
PA = conic : new (z.F,L.dir,1)
curve = PA : points (-4,3,50)
z.K = PA.K
z.S = PA.vertex
}
\begin{tikzpicture}
\tkzGetNodes
\tkzDrawCoordinates [smooth] (curve)
\tkzDrawLines(A,B K,F)
\tkzDrawPoints(A,B,F,K,S)
\tkzLabelPoints(A,B,F,K,S)
\end{tikzpicture}
```

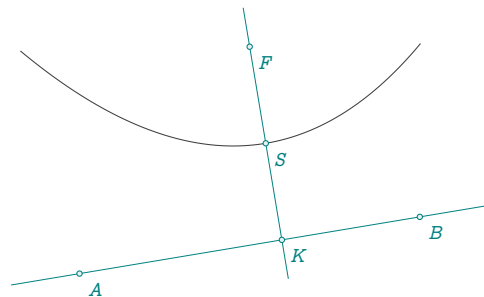

13.7.3 Example points with parabola

```

\directlua{
init_elements ()
z.A = point : new (-2, -1)
z.B = point : new ( 4, 0)
z.F = point : new ( 1 , 3 )
L.dir = line : new (z.A,z.B)
PA = conic : new (z.F,L.dir,1)
curve = PA : points (-4,3,50)
z.K = PA.K
z.S = PA.vertex
L.AF = line : new (z.A,z.F)
L.BF = line : new (z.B,z.F)
z.U = intersection (PA,L.AF)
z.V = intersection (PA,L.BF)
part = PA : points (-4,3,50)
z.HU = L.dir : projection (z.U)
z.HV = L.dir : projection (z.V)
local ta = length(z.HU,z.K)
local tb = length(z.HV,z.K)
part = PA : points (-ta,tb,20)
}
\begin{tikzpicture}
\tkzGetNodes
\tkzDrawCoordinates[smooth](curve)
\tkzDrawCoordinates[smooth,red,thick](part)
\tkzDrawLines(A,B K,F)
\tkzDrawPoints(A,B,F,K,S,HU,HV)
\tkzDrawPoints[red](U,V)
\tkzLabelPoints[red](U,V)
\tkzLabelPoints(A,B,F,K,S)
\end{tikzpicture}

```

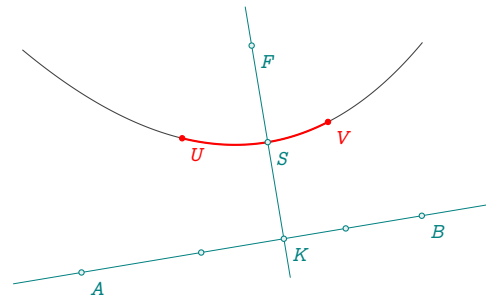

13.7.4 Method points with hyperbola

As with the parabola, t represents the abscissa of a point on the curve. The directrix is the x-axis. To obtain the second branch of the hyperbola, simply add the argument swap.

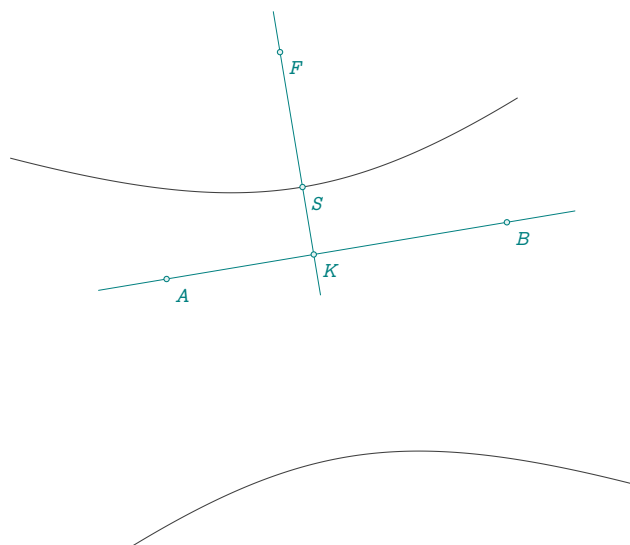

```

\directlua{
  init_elements ()
  z.A  = point: new(-2, -1)
  z.B  = point: new( 4, 0)
  L.AB = line: new(z.A,z.B)
  z.F  = point: new(0,3)
  HY   = conic: new(z.F,L.AB,2)
  curve = HY : points(-5,4,50)
  curveb= HY : points(-5,4,50,swap)
  z.K  = HY.K
  z.S  = HY.vertex
  z.O  = HY.center
}
\begin{tikzpicture}
\tkzGetNodes
\tkzDrawCoordinates[smooth,cyan](curve)
\tkzDrawCoordinates[smooth,cyan](curveb)
\tkzDrawLines(A,B F,K)
\tkzDrawPoints(A,B,F,K,S)
\tkzLabelPoints(A,B,F,K,S)
\end{tikzpicture}

```

13.7.5 Method points with ellipse

This time it's a little different: t is a real number between 0 and 1, representing a fraction of the measure in radians of the angle \widehat{MCV} (C is the center of the ellipse, V the vertex and M a point on the ellipse). Thus $t = 0$ gives the vertex, $t = 1$ also the vertex, $t = .5$ the opposite vertex and $t = .25$ the covertex.

In the next example, I'll show you how to draw only part of the ellipse.

```

\directlua{
  init_elements()
  z.A  = point : new ( 0 , 0 )
  z.B  = point : new ( 4 , 2 )
  L.dir = line : new (z.A,z.B)
  z.F  = point : new ( 2 , 2)
  EL   = conic : new(z.F,L.dir,.8)
  curve = EL : points (0,1,50)
  part = EL : points (0.5,0.75,50)
  z.K  = EL.K
  z.C  = EL.center
  z.V  = EL.vertex
  z.M  = EL : point (.3)
}
\begin{tikzpicture}
\tkzGetNodes
\tkzDrawLines(A,B K,F)
\tkzDrawSegments(C,V C,M)
\tkzDrawPoints(A,B,C,F,K,M,V)
\tkzLabelPoints(A,B,C,F,K,M,V)
\tkzDrawCoordinates[smooth](curve)
\tkzDrawCoordinates[smooth,red,thick](part)
\tkzMarkAngles[mark=||,size=.5](V,C,M)
\end{tikzpicture}

```

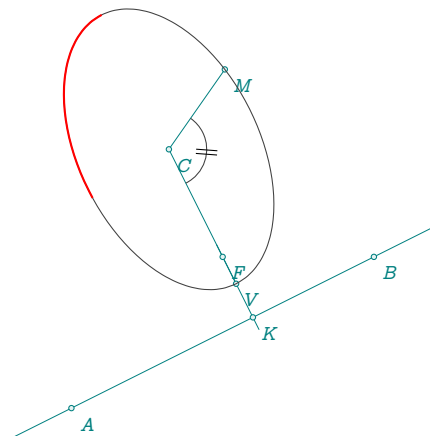

13.7.6 Method `tangent_at`

```

\directlua{
  init_elements ()
  z.A      = point : new ( 0 , 0 )
  z.B      = point : new ( 4 , -2 )
  L.dir    = line  : new (z.A,z.B)
  z.F      = point : new ( 2 , 2)
  C01     = conic  : new(z.F,L.dir,.8)
  C02     = conic  : new(z.F,L.dir, 1)
  C03     = conic  : new(z.F,L.dir, 1.2)
  curve1  = C01 : points (0,1,50)
  curve2  = C02 : points (-5,5,50)
  curve3  = C03 : points (-5,5,50)
  z.X_1   = C01 : point (.3)
  z.X_2   = C02 : point (3)
  z.X_3   = C03 : point (3)
  T1      = C01 : tangent_at (z.X_1)
  T2      = C02 : tangent_at (z.X_2)
  T3      = C03 : tangent_at (z.X_3)
  z.u1,z.v1 = get_points (T1)
  z.u2,z.v2 = get_points (T2)
  z.u3,z.v3 = get_points (T3)
  z.K = C02.K
}
\begin{tikzpicture}
  \tkzGetNodes
  \tkzDrawLines[cyan](A,B K,F)
  \tkzDrawCoordinates[smooth](curve1)
  \tkzDrawCoordinates[smooth](curve2)
  \tkzDrawCoordinates[smooth](curve3)
  \tkzDrawLines[add = 2 and 2,red](u1,v1 u2,v2 u3,v3)
  \tkzDrawPoints[red](X_1,X_2,X_3)
  \tkzDrawPoints(K,F)
  \tkzLabelPoints(K,F)
\end{tikzpicture}

```

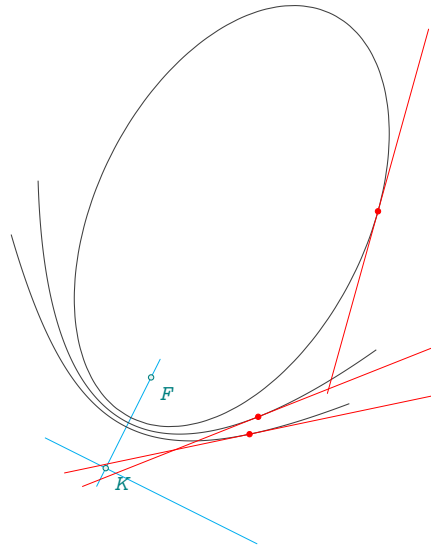
13.7.7 Method `tangent_from`

```

\directlua{
  init_elements ()
  z.A = point : new ( 0 , 0 )
  z.B = point : new ( 2 , -1 )
  L.dir = line : new (z.A,z.B)
  z.F = point : new ( 2 , 2)
  C01 = conic : new(z.F,L.dir,.8)
  C02 = conic : new(z.F,L.dir, 1)
  C03 = conic : new(z.F,L.dir, 1.2)
  curve1 = C01 : points (0,1,50)
  curve2 = C02 : points (-5,6,50)
  curve3 = C03 : points (-5,7,50)
  R1,R2 = C01 : tangent_from (z.B)
  S1,S2 = C02 : tangent_from (z.B)
  T1,T2 = C03 : tangent_from (z.B)
  z.u1,z.v1 = get_points (R1)
  z.u2,z.v2 = get_points (R2)
  z.r1,z.s1 = get_points (S1)

```

```

z.r2,z.s2 = get_points (S2)
z.x1,z.y1 = get_points (T1)
z.x2,z.y2 = get_points (T2)
z.K = C02.K
}
\begin{tikzpicture}
\tkzGetNodes
\tkzDrawLines[cyan](A,B K,F)
\tkzDrawCoordinates[smooth](curve1)
\tkzDrawCoordinates[smooth](curve2)
\tkzDrawCoordinates[smooth](curve3)
\tkzDrawLines[add = 0 and .25,red](B,v1 B,v2 B,s1 B,s2 B,y1 B,y2)
\tkzDrawPoints[red](v1,v2,s1,s2,y1,y2)
\tkzDrawPoints(K,F,B)
\tkzLabelPoints(K,F,B)
\end{tikzpicture}
\end{document}

```

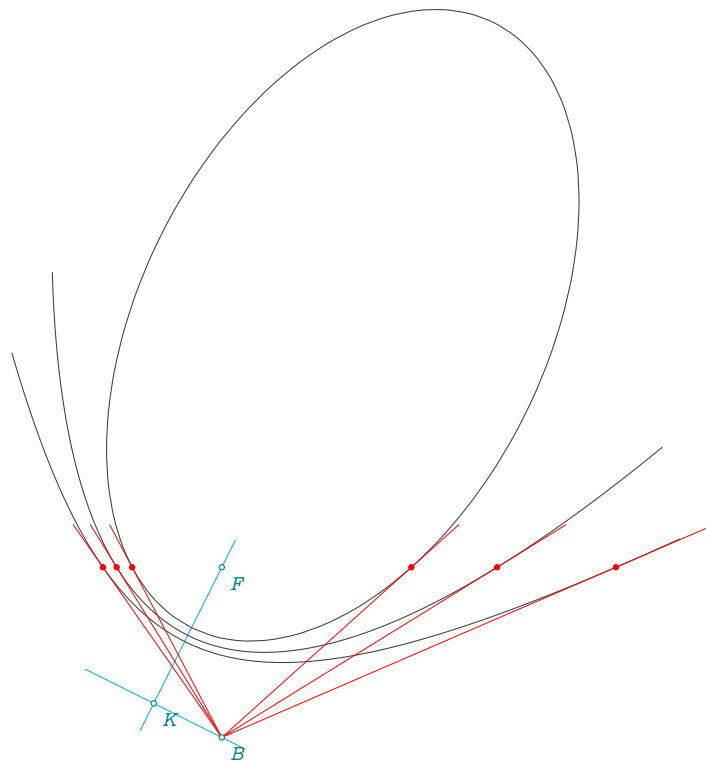

13.7.8 Parabola with focus, axis of symmetry and curve point

```

\directlua{
init_elements ()
z.F = point: new ( 2 , 0 )
z.A = point: new ( 3 , 4 )
L.FA = line : new (z.A,z.F)
z.M = point : new (-1 , 0)
C.MF = circle : new (z.M,z.F)
L.ll = L.FA : ll_from (z.M)
z.H = intersection (C.MF,L.ll)
L.dir = L.FA : ortho_from (z.H)
z.K = intersection (L.dir,L.FA)
PA = conic : new (z.F,L.dir,1)
curve = PA : points (-5,3,20)
}
\begin{tikzpicture}[gridded]
\tkzGetNodes
\tkzDrawCoordinates[smooth](curve)
\tkzDrawLines(A,K M,H K,H)
\tkzDrawSegments[dashed](M,F)
\tkzDrawPoints(A,F,M,H,K)
\tkzLabelPoints(A,F,M,H,K)
\tkzDrawCircle[dashed](M,F)
\end{tikzpicture}

```

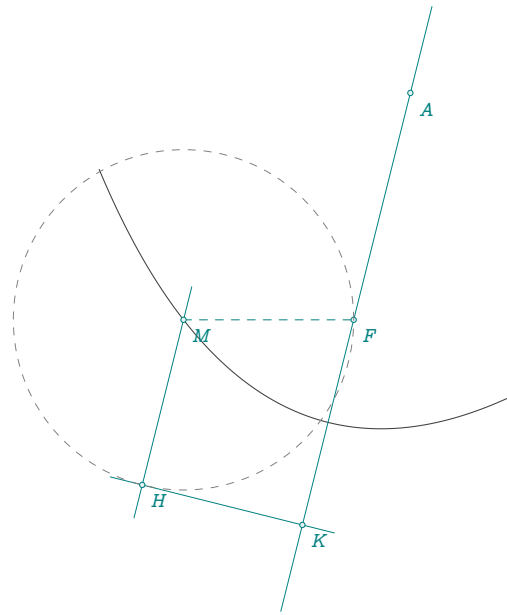

13.7.9 Ellipse with center, vertex and covertex

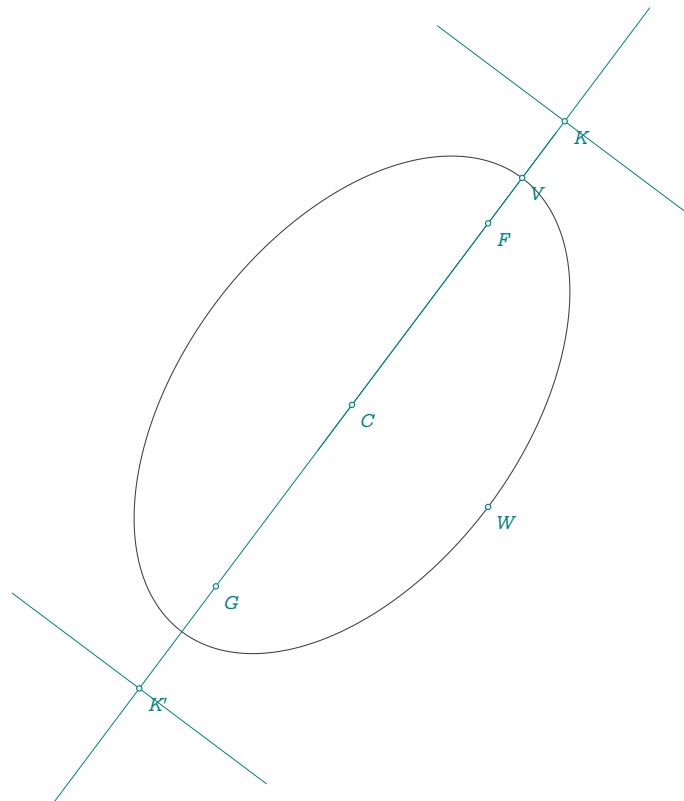

```

\directlua{
init_elements ()
z.C = point : new ( 1 , -1)

```

```

z.V      = point : new ( 4 , 3)
z.W      = (z.C-z.V) : orthogonal (3) : at (z.C)
local a  = length(z.C,z.V)
local b  = length(z.C,z.W)
local c  = math.sqrt(a^2 - b^2)
local e  = c / a
axis     = line : new (z.C,z.V)
% foci
z.F      = axis : report (c,z.C)
z.G      = z.C : symmetry (z.F)
% directrix
z.K      = axis : report ( b^2 / c, z.F )
z.Kp     = axis : report (-b^2 / c, z.G )
%% major_axis
z.u      = (z.C-z.K) : orthogonal (2) : at (z.K)
z.v      = (z.C-z.K) : orthogonal (-2) : at (z.K)
L.dir    = line : new (z.u,z.v)
%% %axis : ortho_from (z.K)
z.r      = (z.C-z.Kp) : orthogonal (2) : at (z.Kp)
z.s      = (z.C-z.Kp) : orthogonal (-2) : at (z.Kp)
C0       = conic : new (z.F,L.dir,e)
curve    = C0 : points (0,1,100)
}

```

```

\begin{tikzpicture}[gridded]
  \tkzGetNodes
  \tkzDrawCoordinates[smooth](curve)
  \tkzDrawLines(u,v r,s K,K')
  \tkzDrawLine(C,V)
  \tkzDrawPoints(V,W,C,F,K,K',G)
  \tkzLabelPoints(V,W,C,F,K,K',G)
\end{tikzpicture}

```

13.7.10 Ellipse with foci and point

The key point here is that the relationship $MF + MG = 2a$ can be used to determine a .

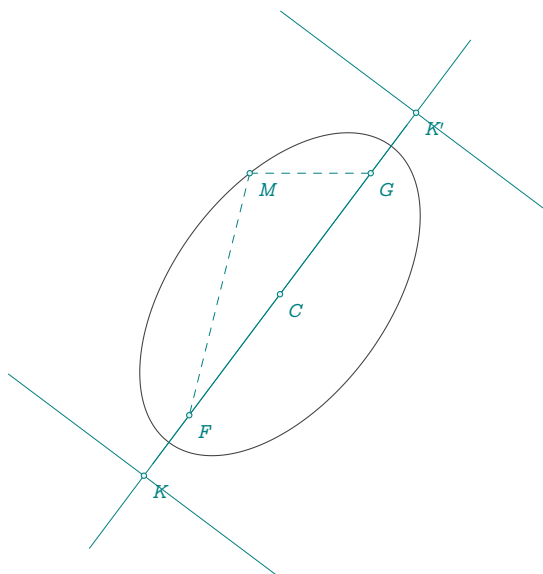

```

\directlua{
init_elements ()
z.F      = point : new ( 1 , -1)
z.G      = point : new ( 4 , 3)
z.M      = point : new ( 2 , 3)
z.C      = midpoint(z.F,z.G)
local a = (length(z.F,z.M)+length(z.G,z.M))/2
local c = length(z.F,z.G)/2
local b = math.sqrt(a^2 - c^2)
local e = c / a
axis     = line : new (z.G,z.F)
% directrix
z.K      = axis: report ( b^2 / c, z.F )
z.Kp     = axis: report (-b^2 / c, z.G )
z.u      = (z.C-z.K): orthogonal(2) : at (z.K)
z.v      = (z.C-z.K): orthogonal(-2): at (z.K)
L.dir    = line: new (z.u,z.v)
z.r      = (z.C-z.Kp): orthogonal(2): at (z.Kp)
z.s      = (z.C-z.Kp): orthogonal(-2): at (z.Kp)
CO       = conic: new (z.F,L.dir,e)
curve    = CO: points (0,1,100)
}
\begin{tikzpicture}[scale = .5]
\tkzGetNodes
\tkzDrawCoordinates[smooth](curve)
\tkzDrawLines(u,v r,s K,K')
\tkzDrawSegments[dashed](M,F M,G)
\tkzDrawLine(F,G)
\tkzDrawPoints(C,F,K,K',G,M)
\tkzLabelPoints(C,F,K,K',G,M)
\end{tikzpicture}

```

13.7.11 Method point

This method is similar to method `point` from other classes, with some specific differences. The argument t depends on the conic section. Frequently, t is a real number between 0 and 1, which expresses a percentage of a given distance. This is not the case, of course, for the parabola and the hyperbola. In these cases, t is the abscissa on the directrix of a point on the curve. On the other hand, for the ellipse, t has the same meaning as for a circle. In fact, the point on the ellipse is derived from a point on the principal circle by an affinity transformation with a ratio of b/a .

Refer to [13.7.6].

A few remarks on the following example. It shows how the affinity ellipse can be obtained from the main circle.

Thus we have $HQ' = \frac{b}{a}HQ$, likewise $\tan(\beta) = \frac{b}{a}\tan(\alpha)$.

```

\directlua{
  init_elements ()
  z.Fb = point: new ( 3 , 0 )
  z.Fa = point: new ( -3 , 2 )
  local c = length(z.Fa,z.Fb)/2
  local a = 4
  local b = math.sqrt(a^2 - c^2)
  local e = c/a
  L.FaFb = line : new (z.Fa,z.Fb)
  z.C = L.FaFb.mid
  z.K = report_(z.C,z.Fb,a^2/c)
  z.Ko = ortho_from_(z.K,z.K,z.Fb)
  L.dir = line :new(z.K,z.Ko)
  EL = conic : new (z.Fb,L.dir,e)
  curve = EL : points (0,1,100)
  z.X = EL.vertex
  C.X = circle : new (z.C,z.X)
  z.Q = C.X : point(.15)
  z.H = L.FaFb : projection (z.Q)
  z.Qp = L.FaFb : affinity
  (L.FaFb : ortho_from(z.C),b/a,z.Q)
}
\begin{tikzpicture}
\tkzGetNodes
\tkzDrawCoordinates[smooth](curve)
\tkzDrawLines(Fa,Fb K,Ko)
\tkzDrawLines[add = 2 and 2](K,Ko)
\tkzDrawCircles(C,Q)
\tkzDrawSegments[dashed](C,Q C,Q' H,Q)
\tkzDrawPoints(Fa,Fb,C,X,Q,Q',H)
\tkzLabelPoints(Fa,Fb,C,X,Q,Q',H)
\tkzLabelAngle(Fb,C,Q'){\beta}
\tkzMarkAngle[size=.8](Fb,C,Q')
\tkzLabelAngle[pos=1.5](Fb,C,Q){\alpha}
\tkzMarkAngle[size=1.3](Fb,C,Q)
\end{tikzpicture}

```

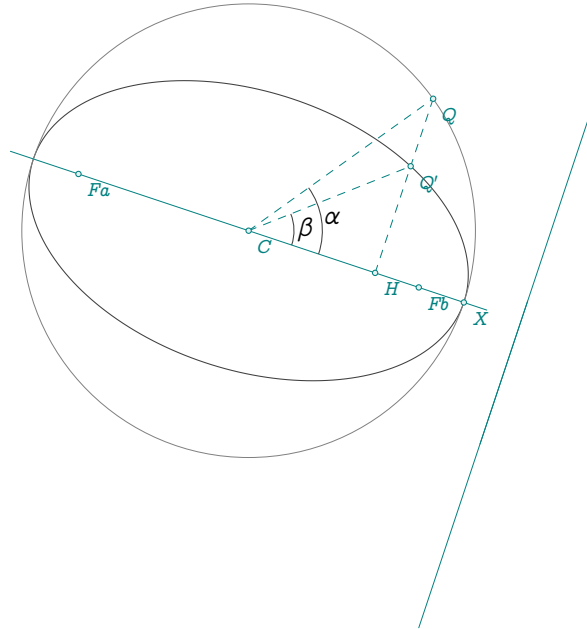

13.7.12 Method in_out

```

\directlua{
init_elements ()
  z.A   = point : new ( 0 , 0 )
  z.B   = point : new ( 4 , -2 )
  L.dir = line  : new (z.A,z.B)
  z.F   = point : new ( 2 , 2 )
  EL    = conic : new(z.F,L.dir,.8)
  PA    = conic : new(z.F,L.dir, 1)
  HY    = conic : new(z.F,L.dir, 1.2)
  curve1 = EL : points ( 0,1,50)
  curve2 = PA : points (-5,5,50)
  curve3 = HY : points (-5,5,50)
  z.L   = point : new (-2,4)
  Lel   = tostring(EL : in_out (z.L))
  Lpa   = tostring(PA : in_out (z.L))
  Lhy   = tostring(HY : in_out (z.L))
  z.M   = point : new (-1,5)
  Mel   = tostring(EL : in_out (z.M))
  Mpa   = tostring(PA : in_out (z.M))
  Mhy   = tostring(HY : in_out (z.M))
  z.N   = point : new (0,6)
  Nel   = tostring(EL : in_out (z.N))
  Npa   = tostring(PA : in_out (z.N))
  Nhy   = tostring(HY : in_out (z.N))
  z.O   = point : new (1,7)
  Oel   = tostring(EL : in_out (z.O))
  Opa   = tostring(PA : in_out (z.O))
  Ohy   = tostring(HY : in_out (z.O))
}

```

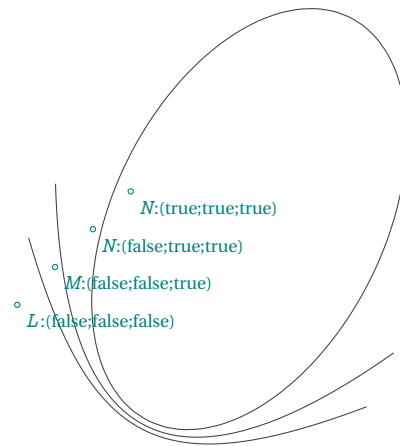

```

\begin{tikzpicture}
\tkzGetNodes
\tkzDrawCoordinates[smooth](curve1)
\tkzDrawCoordinates[smooth](curve2)
\tkzDrawCoordinates[smooth](curve3)
\tkzDrawPoints(L)
\tkzLabelPoint(L){$L$:(\tkzUseLua{Lel};\tkzUseLua{Lpa};\tkzUseLua{Lhy})}
\tkzDrawPoints(M)
\tkzLabelPoint(M){$M$:(\tkzUseLua{Mel};\tkzUseLua{Mpa};\tkzUseLua{Mhy})}
\tkzDrawPoints(N)
\tkzLabelPoint(N){$N$:(\tkzUseLua{Nel};\tkzUseLua{Npa};\tkzUseLua{Nhy})}
\tkzDrawPoints(O)
\tkzLabelPoint(O){$O$:(\tkzUseLua{Oel};\tkzUseLua{Opa};\tkzUseLua{Ohy})}
\end{tikzpicture}

```

13.7.13 Method orthoptic

In the geometry of curves, an orthoptic is the set of points for which two tangents of a given curve meet at a right angle. In the case of the parabola, this curve is the directrix. For the hyperbola and ellipse, it's a circle, but for the hyperbola, the eccentricity must be between 1 and $\sqrt{2}$.⁶

⁶ When the eccentricity is equal to $\sqrt{2}$, then the hyperbola is equilateral. The asymptotes in a good orthonormal frame of reference have equations $y = x$ and $y = -x$.

```

\directlua{
  init_elements ()
  z.A      = point : new ( 0 , 1 )
  z.B      = point : new ( 4 , 3 )
  z.F      = point : new ( 2 , 6 )
  L.AB     = line  : new (z.A,z.B)
  PA       = conic : new (z.F,L.AB,1)
  curve    = PA : points (-5,5,50)
  z.K      = PA.K
  z.S      = PA.vertex
  z.M      = PA : point(-3)
  z.H      = PA.directrix : projection (z.M)
  L.FH     = line  : new (z.F,z.H)
  L.med    = L.FH : mediator ()
  z.P      = intersection (L.AB,L.med)
  z.N      = PA : tangent_from (z.P).pb
  D        = PA : orthoptic ()
  z.v      = D :point(0.75)
  T1,T2    = PA : tangent_from(z.v)
  z.t1     = T1.pb
  z.t2     = T2.pb
}
\begin{tikzpicture}
\tkzGetNodes
\tkzDrawCoordinates[smooth,thick,purple](curve)
\tkzDrawLines[add = 0 and .2](v,t1 v,t2 P,N)
\tkzDrawLines[add = .5 and .5](A,B M,P K,F)
\tkzDrawSegments(M,H H,F F,M)
\tkzDrawPoints(F,K,P,M,H,v,t1,t2,S,N)
\tkzLabelPoints(K,P,M,H,S)
\tkzLabelPoints[right](F,N)
\tkzMarkAngles[mark=| |](H,M,P P,M,F)
\tkzMarkSegments[mark=x](H,M M,F)
\tkzMarkSegments[mark=|](F,S K,S)
\end{tikzpicture}

```

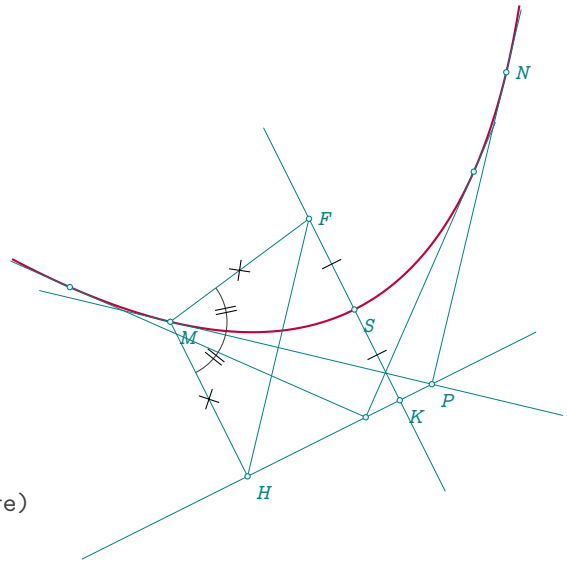

13.8 Intersection line - conic

You will of course find some additional information in the [23] section, particularly in [23.4].

Here's an example, with the three different types of conics and the same straight line. As with other intersections, you don't need to worry about the type of curve, the package will determine the class. For the moment, intersections only concern straight lines with conics.

```

\directlua{
init_elements ()
z.A      = point : new ( 0 , 0 )
z.B      = point : new ( 4 , -2 )
L.dir    = line  : new (z.A,z.B)
z.F      = point : new ( 2 , 2 )
C01      = conic : new(z.F,L.dir,.8)
C02      = conic : new(z.F,L.dir, 1)
C03      = conic : new(z.F,L.dir, 1.2)
curve1   = C01 : points ( 0,1,50)
curve2   = C02 : points (-5,5,50)
curve3   = C03 : points (-5,5,50)
z.K      = C01.K
z.u,z.v  = get_points(C01.major_axis)
z.x      = L.dir : report (-3,z.K)
z.y      = L.dir : report ( 3,z.K)
z.r      = point : new ( 0 , 4 )
z.s      = point : new ( 4 , 1 )
L.rs     = line  : new (z.r,z.s)
z.u_1,z.u_2 = intersection (L.rs,C01)
z.v_1,z.v_2 = intersection (L.rs,C02)
z.w_1,z.w_2 = intersection (L.rs,C03)
}
\begin{tikzpicture}
\tkzGetNodes
\tkzDrawCoordinates[smooth](curve1)
\tkzDrawCoordinates[smooth](curve2)
\tkzDrawCoordinates[smooth](curve3)
\tkzDrawLines[add =.5 and .5](r,s u,v x,y)
\tkzDrawPoints[red](u_1,u_2,v_2,v_1,w_1,w_2)
\end{tikzpicture}

```

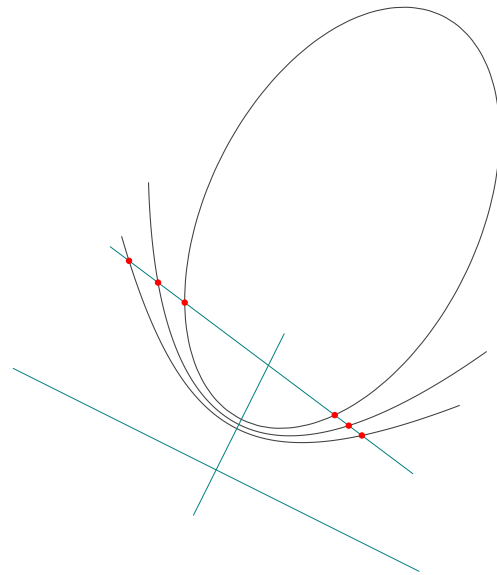

13.9 Useful tools

These tools are functions for obtaining the focus, directrix and eccentricity of a conic.

13.9.1 PA_dir

The parameters are the focus and two points on the parabola. The method used by this function is to consider circles centered on the two points passing through the focus. The tangent line common to both circles is the directrix. There are two solutions.

We replace `_,L.dir` by `L.dir,_` to obtain the second solution.

```

\directlua{
init_elements ()
  z.A      = point: new ( 0 , 1)
  z.B      = point: new ( 5 , 2)
  z.F      = point: new ( 2 , -1)
  _,L.dir  = PA_dir(z.F,z.A,z.B)
  PA       = conic : new (z.F,L.dir,1)
  curve    = PA: points (-5,5,50)
  z.T,z.Tp= get_points(L.dir)
}
\begin{tikzpicture}[scale = .5]
  \tkzGetNodes
  \tkzDrawCoordinates[smooth,cyan](curve)
  \tkzDrawCircles(A,F B,F)
  \tkzDrawPoints(A,B,F,T,T')
  \tkzDrawLine(T,T')
  \tkzLabelPoints(A,B,F,T,T')
\end{tikzpicture}

```

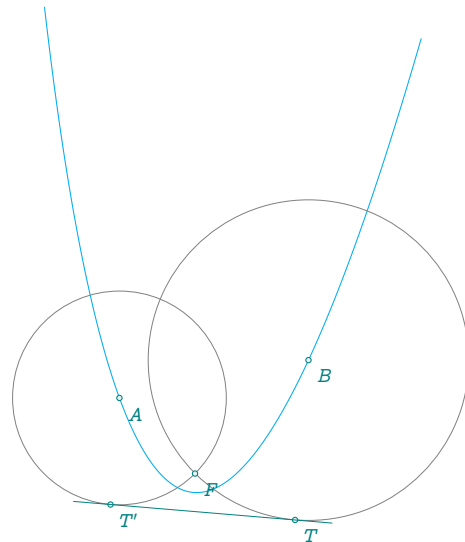

13.9.2 PA_focus

This time the arguments are the directrix, and two points. Of course we're looking for the focus.

La méthode consiste encore à considérer deux cercles centrés aux deux points et tangents à la ligne directrice. Si c'est possible, le foyer se trouve à l'un des deux points communs aux cercles.

```

\directlua{
init_elements ()
  z.A      = point: new ( 0 , 1)
  z.B      = point: new ( 4 , 2)
  z.u      = point: new ( 2 , -1)
  z.v      = point: new (-2 , 0)
  L.dir    = line : new (z.u,z.v)
  z.hA     = L.dir : projection (z.A)
  z.hB     = L.dir : projection (z.B)
  z.F,z.G  = PA_focus (L.dir,z.A,z.B)
  PA       = conic : new (z.F,L.dir,1)
  curve    = PA: points (-5,5,50)
}
\begin{tikzpicture}
  \tkzGetNodes
  \tkzDrawCoordinates[smooth,cyan](curve)
  \tkzDrawCircles(A,hA B,hB)
  \tkzDrawLines(u,v)
  \tkzDrawPoints(A,B,u,v,hA,hB,F,G)
  \tkzLabelPoints(A,B,F,G,u,v)
\end{tikzpicture}

```

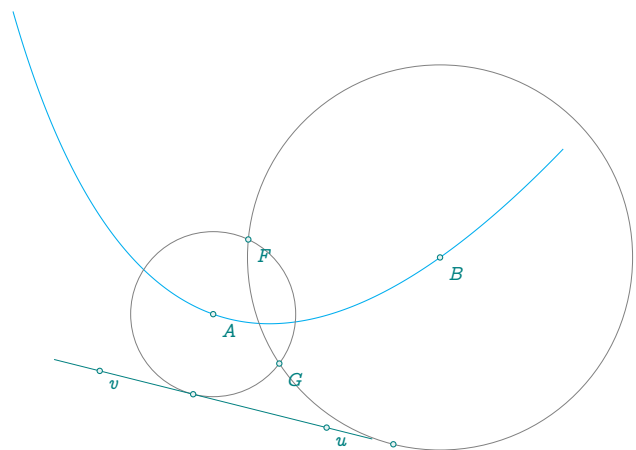

13.9.3 HY_bifocal

For the hyperbola, only one tool is currently available, based on the bifocal definition. The arguments are the two foci and either the real a (distance from the center to one of the vertices), or a point on the curve. The method is simple, and consists in determining the various attributes using the formulas that characterize them.

```

\directlua{
init_elements ()
z.F      = point : new ( 1 , -1)
z.G      = point : new ( 4 , 3)
z.M      = point : new ( 6 , 2)
z.C      = midpoint(z.F,z.G)
HY       = conic : new (HY_bifocal(z.G,z.F,z.M))
curve    = HY : points (-3,3,50)
z.K      = HY.K
curveb   = HY : points (-3,3,50,swap)
}
\begin{tikzpicture}[scale = .5]
\tkzGetNodes
\tkzDrawCoordinates[smooth,red](curve)
\tkzDrawCoordinates[smooth,red](curveb)
\tkzDrawSegments[dashed](M,F M,G)
\tkzDrawLine(F,G)
\tkzDrawPoints[red](M)
\tkzDrawPoints(C,F,G,K)
\tkzLabelPoints(C,F,G,K)
\end{tikzpicture}

```

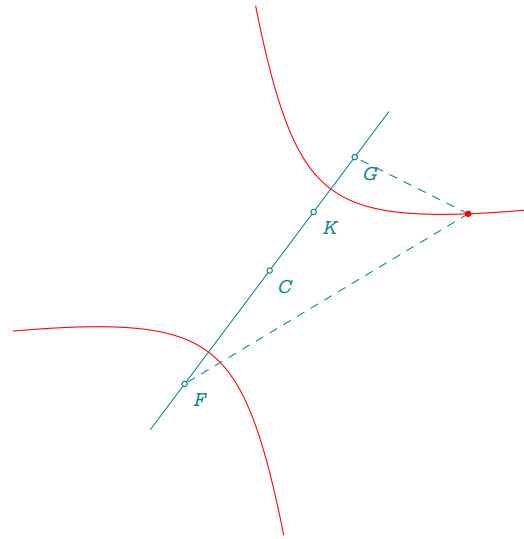

13.9.4 EL_bifocal

For the ellipse, we have two options. The first tool is EL_bifocal like for hyperbola.

```

\directlua{
init_elements ()
z.F      = point : new ( 1 , -1)
z.G      = point : new ( 4 , 3)
z.M      = point : new ( 2 , 4)
z.C      = midpoint(z.F,z.G)
local a  = (length(z.F,z.M)+length(z.G,z.M))/2
EL       = conic : new (EL_bifocal(z.F,z.G,z.M))
curve    = EL : points (0,1,100)
L.dir    = EL.directrix
z.K      = EL.K
z.Kp     = z.C : symmetry (z.K)
z.u,z.v  = get_points(EL.minor_axis)
z.r,z.s  = get_points(EL.directrix)
}
\begin{tikzpicture}[scale = .5]
\tkzGetNodes
\tkzDrawCoordinates[smooth](curve)
\tkzDrawLines[add = .5 and .5](K,K' u,v r,s)
\tkzDrawSegments[dashed](M,F M,G)
\tkzDrawPoints(C,F,K,K',G,M)
\tkzLabelPoints(C,F,K,K',G,M)
\end{tikzpicture}

```

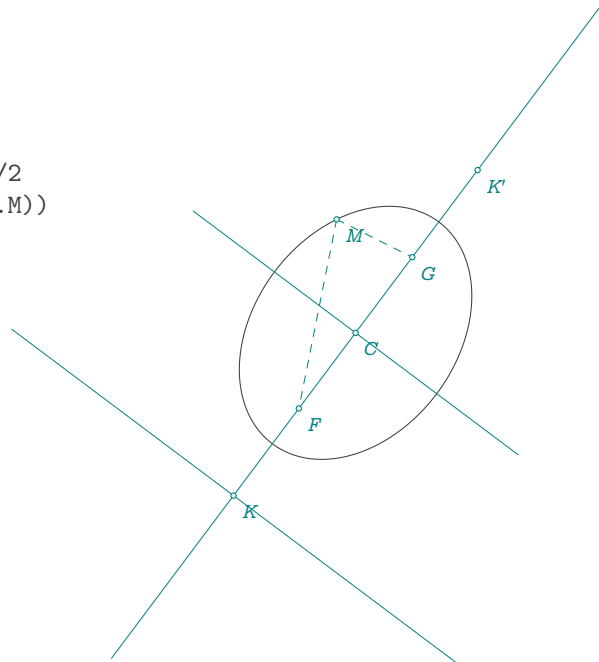

13.9.5 EL_points

The second allows us to return to the old method, which used the center, vertex and covertex of the ellipse. To obtain the three arguments now required, you need to apply the EL_points function.

I've left the programming lines, which are replaced by the function shown.

```

\directlua{
init_elements ()
z.C      = point : new ( 1 , -1)
z.V      = point : new ( 4 , 3)
z.W      = (z.C-z.V) : orthogonal (3) : at (z.C)
local a  = length(z.C,z.V)
local b  = length(z.C,z.W)
local c  = math.sqrt(a^2 - b^2)
local e  = c / a
axis     = line : new (z.C,z.V)
% foci
z.F      = axis : report (c,z.C)
z.G      = z.C : symmetry (z.F)
% directrix
z.K      = axis : report ( b^2 / c , z.F )
z.Kp     = axis : report (-b^2 / c , z.G )
% major_axis
z.u      = (z.C-z.K) : orthogonal (2) : at (z.K)
z.v      = (z.C-z.K) : orthogonal (-2) : at (z.K)
L.dir    = line : new (z.u,z.v)
% axis : ortho_from (z.K)
z.r      = (z.C-z.Kp) : orthogonal (2) : at (z.Kp)
z.s      = (z.C-z.Kp) : orthogonal (-2) : at (z.Kp)
%CO
CO       = conic : new (z.F,L.dir,e)
CO       = conic : new (EL_points(z.C,z.V,z.W))
curve    = CO : points (0,1,100)
}
\begin{tikzpicture}[gridded]
\tkzGetNodes
\tkzDrawCoordinates[smooth](curve)
\tkzDrawLines(u,v r,s K,K')
\tkzDrawLine(C,V)
\tkzDrawPoints(V,W,C,F,K,K',G)
\tkzLabelPoints(V,W,C,F,K,K',G)
\end{tikzpicture}

```

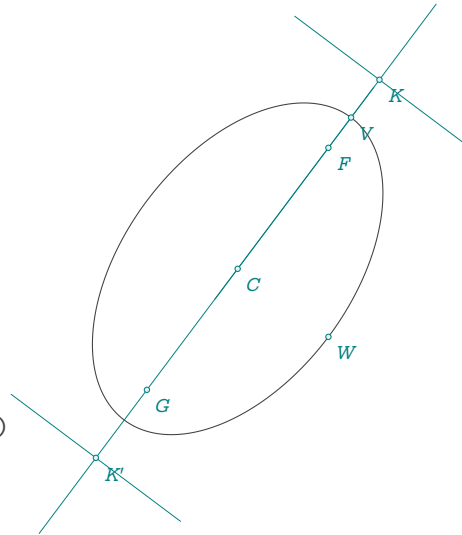

14 Orthormal cartesian coordinate system

This new class is still experimental. I mainly use it for drawing conics.

It is also an opportunity to remind you of some key concepts related to this package. Although the goal of the package is not to use equations, drawing with TikZ requires a coordinate system. To keep development simple, I have chosen to work exclusively with an orthonormal Cartesian coordinate system (OCCS).

For now, the objective is to transition from one orthonormal Cartesian coordinate system to another, also orthonormal. The new coordinate system is obtained from the first through translation and rotation. The arguments are a straight line that defines the direction of the new ordinate axis and a point that will serve as the center of the new coordinate system.

Let's consider a concrete example. We want to find the intersections of a parabola with a straight line. The parabola is defined by a directrix and a focus. In a reference frame centered at the vertex S of the parabola, with the x-axis being a parallel passing through this vertex to the directrix, the equation of the parabola is $y = \frac{x^2}{2p}$,

where p is the value of the latus rectum. This corresponds to the length of the segment originating from the focus, parallel to the directrix, and ending on the parabola. p is also the distance from the focus to the directrix.

To find the intersections, we simply determine the equation of the line in the new reference frame and use $y = \frac{x^2}{2p}$ as the equation of the curve. In this example, two internal functions are used. It is best not to use them at this stage, as their names may change. The function `param_line` is used to determine the coefficients of the line, and `solve_para_line` finds the intersection points.

If solutions exist, the result provides two values, r_1 and r_2 , which are the abscissas of the intersection points in the new reference frame. After computing the ordinates, one could use a function to determine the coordinates in TikZ within the new coordinate system. However, there is another approach: we determine the points x and y corresponding to the values found (r_1, r_2) on the abscissa axis of the new reference frame `OCCS.abscissa`. Then, geometrically, we locate the intersection points on the parabola.

```
\directlua{
  init_elements ()
  z.O      = point : new (0,0)
  z.i      = point : new (1,0)
  z.j      = point : new (0,1)
  z.A      = point : new (-1 , 0)
  z.B      = point : new (5 , 4)
  L.dir    = line  : new (z.A , z.B)
  z.F      = point : new (0 , 3)
  PA       = conic : new (z.F,L.dir,1)
  curve    = PA    : points (-3,3,50)
  local p  = PA.p
  z.P      = L.dir : report (p,z.K)
  z.X      = PA : point (p)
  z.H      = L.dir : projection (z.X)
  z.K      = PA.K
  z.S      = PA.vertex
  L.KF     = PA.major_axis
  % new occs
  OCCS     = occs  : new (L.KF,z.S)
  z.u      = OCCS.x
  z.v      = OCCS.y
  % line a,b
  z.a      = point : new (-1,1)
  z.b      = point : new (3,5)
  L.ab     = line  : new (z.a,z.b)
  % % coordinates in the new occs
  X,Y      = OCCS : coordinates (z.F)
  Xa,Ya    = OCCS : coordinates (z.a)
```

```

Xb,Yb      = OCCS : coordinates (z.b)
% solve in the new occs
local r,s = param_line (Xa,Ya,Xb,Yb)
r1,r2      = solve_para_line (p,r,s)
z.x        = OCCS.abscissa :report(r1,z.K)
z.y        = OCCS.abscissa :report(r2,z.K)
L1         = L.dir : ortho_from (z.x)
L2         = L.dir : ortho_from (z.y)
z.s1       = intersection (L.ab,L1)
z.s2       = intersection (L.ab,L2)
}

\begin{tikzpicture}
  \tkzGetNodes
  \tkzDrawCoordinates[smooth,orange,thick] (curve)
  \tkzDrawLines(A,B)
  \tkzDrawLines[add = 1 and 1] (K,F)
  \tkzDrawSegments[add = .5 and .5,blue] (a,b)
  \tkzDrawSegments[dashed] (s1,x s2,y)
  \tkzDrawPoints(A,B,F,K,S)
  \tkzDrawPoints[blue,size=2] (a,b)
  \tkzDrawPoints[blue,size=2] (s1,s2,x,y)
  \tkzLabelPoints[blue] (a,b)
  \tkzLabelPoints[blue,above left] (s1,s2)
  \tkzLabelPoints(O,i,u,S,A,B,x,y)
  \tkzLabelPoints[left] (j,v)
  \tkzLabelPoints[right] (F,K)
  \tkzDrawSegments[->,red,thick] (O,i O,j)
  \tkzDrawSegments[->,purple,thick] (S,u S,v)
  \tkzLabelSegment[below,sloped,pos=.7] (A,B){Directrix}
\end{tikzpicture}

```

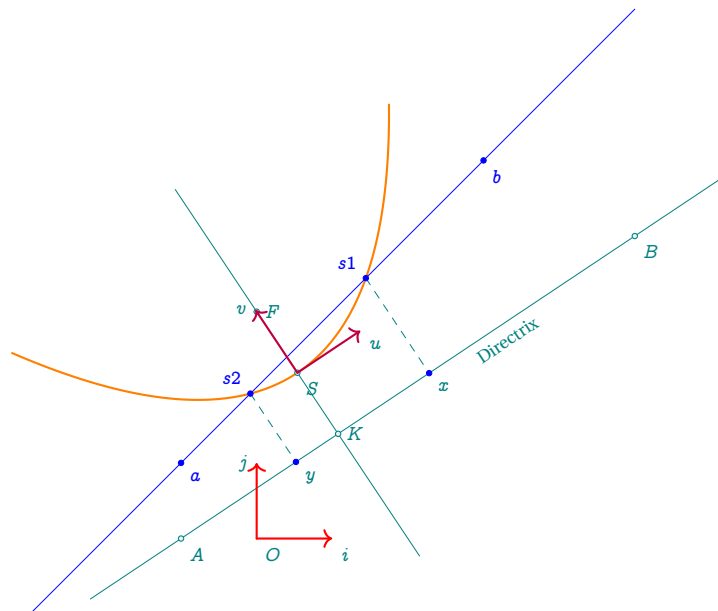

14.1 Attributes of an occs

```
Creation:  sys = occs: new (L.AB,z.S)
```

Table 13: occs attributes.

Attributes	Application
type	sys.type = "occs"
origin	sys.origin = z.S
x	sys.x = z.I SI = 1
y	sys.x = z.J SJ = 1
abscissa	sys.abscissa = L.SI
ordinate	sys.ordinate = L.SJ

14.1.1 Example: attributes of occs

A few words about the arguments of the new method. The most important is the line that will support the new ordinate axis. For a parabola, its orientation should be from the director to the focus, and for a hyperbola or ellipse, from the center to the main focus. The orientation (direction) is that which runs from the first point to the second in the creation of the line.

If this line is obtained as an orthogonal line to another line (as in the following example), then the direction will depend on the latter.

```

\directlua{
z.0      = point : new (0,0)
z.i      = point : new (1,0)
z.j      = point : new (0,1)
z.A      = point : new (-1 , -1)
z.B      = point : new (4 , 2)
L.AB     = line  : new (z.A , z.B)
z.S      = point : new (0 , 3)
L.axis   = L.AB : ortho_from (z.S)
% new occs
sys      = occs  : new (L.axis,z.S)
z.u      = sys.x
z.v      = sys.y
z.ax     = sys.abscissa.pa
z.bx     = sys.ordinate.pa
z.ay     = sys.abscissa.pb
z.by     = sys.ordinate.pb
}
\begin{tikzpicture}
\tkzGetNodes
\tkzDrawLines(A,B)
\tkzDrawLines[purple,add=4 and 4](ax,ay bx,by)
\tkzDrawSegments[->,red,thick](0,i 0,j)
\tkzDrawSegments[->,purple,thick](S,u S,v)
\tkzLabelSegment[below,sloped,pos=.9](A,B){L.AB the directrix}
\tkzLabelSegment[below,sloped,pos=3](ax,ay){abscissa}
\tkzLabelSegment[below,sloped,pos=5](bx,by){ordinate major\_axis}
\tkzLabelPoints(0,S)
\tkzLabelPoints[left](j,v)
\tkzLabelPoints[below right](i,u)
\end{tikzpicture}

```

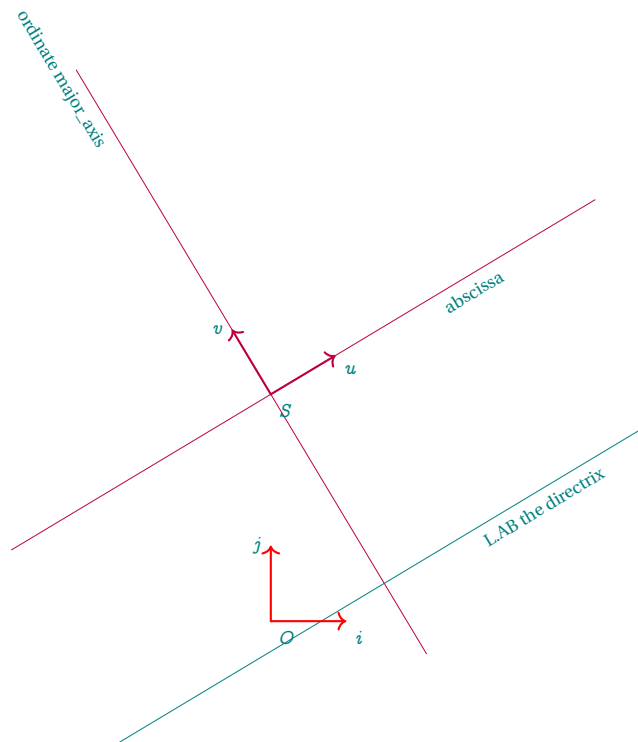

14.2 Methods of the class occs

Currently, there are only two methods. `new` for creation and `coordinates` for obtaining the new coordinates of a point.

The affix of S in the original system is $3.00i$. The new coordinates of S are u and v . The affix of u in the original system is $0.86 + 3.51i$. The new coordinates of u are u and v .

The point M whose coordinates are $(2,6)$ in the original system has coordinates $(4.6305; 1.8865)$ in the new one.

```
\directlua{
z.O      = point : new (0,0)
z.i      = point : new (1,0)
z.j      = point : new (0,1)
z.A      = point : new (-1 , -1)
z.B      = point : new (4 , 2)
L.AB     = line  : new (z.A , z.B)
z.S      = point : new (-1 , 2)
L.axis   = L.AB : ortho_from (z.S)
% new occs
sys      = occs  : new (L.axis,z.S)
z.u      = sys.x
z.v      = sys.y
z.ax     = sys.abscissa.pa
z.bx     = sys.ordinate.pa
z.ay     = sys.abscissa.pb
z.by     = sys.ordinate.pb
XS,YS    = sys : coordinates (z.S)
Xu,Yu    = sys : coordinates (z.u)
Xv,Yv    = sys : coordinates (z.v)
z.M      = point : new (2,6)
XM,YM    = sys : coordinates (z.M)
z.xm     = sys.abscissa :projection (z.M)
z.ym     = sys.ordinate  :projection (z.M)
```

```

}

\begin{tikzpicture}[gridded]
\tkzGetNodes
\tkzDrawLines(A,B)
\tkzDrawLines[purple,add=4 and 4](ax,ay bx,by)
\tkzDrawSegments[->,red,thick](O,i O,j)
\tkzDrawSegments[->,purple,thick](S,u S,v M,xm M,ym)
\tkzDrawPoint(M)
\tkzLabelPoint[above](M){$M:$ ($\pmpn{\tkzUseLua{XM}};\pmpn{\tkzUseLua{YM}})$}
\tkzLabelPoints(O,S)
\tkzLabelPoints[left](j,v)
\tkzLabelPoints[below right](i,u)
\end{tikzpicture}

```

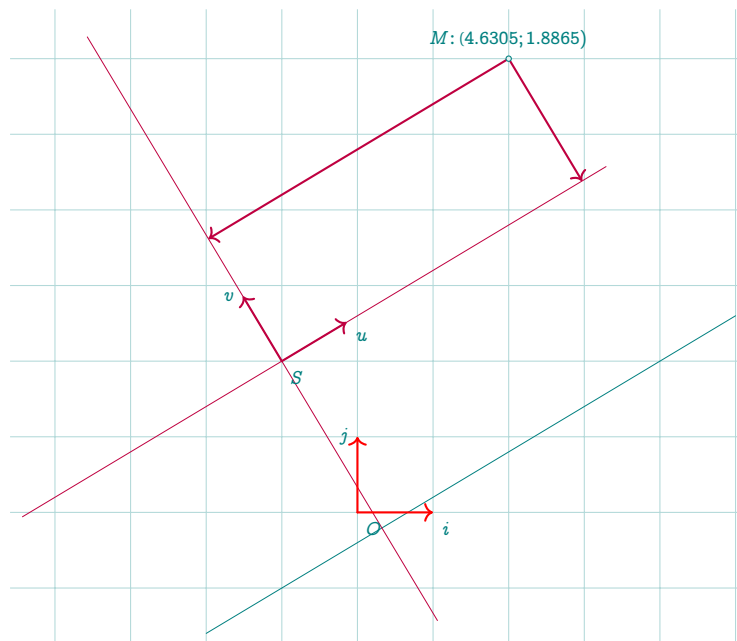

15 Class quadrilateral

15.1 Quadrilateral Attributes

Points are created in the direct direction. A test is performed to check whether the points form a rectangle, otherwise compilation is blocked.

```
Creation Q.new = rectangle : new (z.A,z.B,z.C,z.D)
```

Table 14: rectangle attributes.

Attributes	Application	
pa	z.A = Q.new.pa	
pb	z.B = Q.new.pb	
pc	z.C = Q.new.pc	
pd	z.D = Q.new.pd	
type	Q.new.type= 'quadrilateral'	
i	z.I = Q.new.i	intersection of diagonals
g	z.G = Q.new.g	barycenter
a	AB = Q.new.a	barycenter
b	BC = Q.new.b	barycenter
c	CD = Q.new.c	barycenter
d	DA = Q.new.d	barycenter
ab	Q.new.ab	line passing through two vertices
ac	Q.new.ca	idem.
ad	Q.new.ad	idem.
bc	Q.new.bc	idem.
bd	Q.new.bd	idem.
cd	Q.new.cd	idem.

15.1.1 Quadrilateral attributes

```
\directlua{%
init_elements ()
z.A = point : new ( 0 , 0 )
z.B = point : new ( 4 , 0 )
z.C = point : new ( 5 , 1 )
z.D = point : new ( 0 , 3 )
Q.ABCD = quadrilateral : new (z.A, z.B, z.C, z.D)
z.I = Q.ABCD.i
z.G = Q.ABCD.g
}
```

```
\begin{tikzpicture}
\tkzGetNodes
\tkzDrawPolygon(A,B,C,D)
\tkzDrawSegments(A,C B,D)
\tkzDrawPoints(A,B,C,D,I,G)
\end{tikzpicture}
```

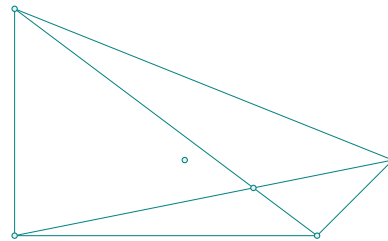

15.2 Quadrilateral methods

Table 15: Quadrilateral methods.

Methods	Comments
iscyclic ()	inscribed? (Refer to next example)

15.2.1 Inscribed quadrilateral

```

\directlua{%
init_elements ()
z.A      = point : new ( 0 , 0 )
z.B      = point : new ( 4 , 0 )
z.D      = point : polar ( 4 , 2*math.pi/3 )
L.DB     = line : new (z.D,z.B)
T.equ    = L.DB : equilateral ()
z.C      = T.equ.pc
Q.new    = quadrilateral : new(z.A,z.B,z.C,z.D)
bool     = Q.new : iscyclic ()
if bool == true then
C.cir    = triangle : new(z.A,z.B,z.C)
: circum_circle()
z.O      = C.cir.center
end
}

\begin{tikzpicture}
\tkzGetNodes
\tkzDrawPolygon(A,B,C,D)
\tkzDrawPoints(A,B,C,D)
\tkzLabelPoints(A,B,C,D)
\tkzDrawCircle(O,A)
\ifthenelse{\equal{\tkzUseLua{bool}}{true}}{
\tkzDrawCircle(O,A)}{}
\end{tikzpicture}

```

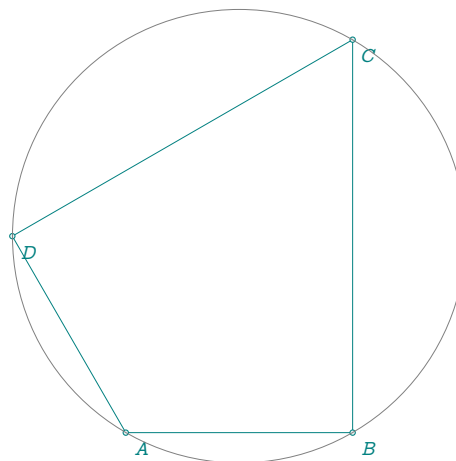

16 Class square

16.1 Square attributes

Points are created in the direct direction. A test is performed to check whether the points form a square. Otherwise, compilation is blocked.”

```
Creation S.AB = square : new (z.A,z.B,z.C,z.D)
```

Table 16: Square attributes.

Attributes	Application	
pa	z.A = S.AB.pa	
pb	z.B = S.AB.pb	
pc	z.C = S.AB.pc	
pd	z.D = S.AB.pd	
type	S.AB.type= 'square'	
side	s = S.AB.center	s = length of side
center	z.I = S.AB.center	center of the square
circumradius	S.AB.circumradius	radius of the circumscribed circle
inradius	S.AB.inradius	radius of the inscribed circle
proj	S.AB.proj	projection of the center on one side
ab	S.AB.ab	line passing through two vertices
ac	S.AB.ca	idem.
ad	S.AB.ad	idem.
bc	S.AB.bc	idem.
bd	S.AB.bd	idem.
cd	S.AB.cd	idem.

16.1.1 Example: square attributes

```
\directlua{%
init_elements ()
z.A      = point  : new ( 0 , 0 )
z.B      = point  : new ( 4 , 0 )
z.C      = point  : new ( 4 , 4 )
z.D      = point  : new ( 0 , 4 )
S.new    = square : new ( z.A , z.B ,z.C,z.D)
z.I      = S.new.center
z.H      = S.new.proj
}
\begin{tikzpicture}
\tkzGetNodes
\tkzDrawCircles[orange](I,A I,H)
\tkzDrawPolygon(A,B,C,D)
\tkzDrawPoints(A,B,C,D,H,I)
\tkzLabelPoints(A,B,H,I)
\tkzLabelPoints[above](C,D)
\tkzDrawSegments(I,B I,H)
\tkzLabelSegment[sloped](I,B){\pmpn{\tkzUseLua{S.new.circumradius}}}
\tkzLabelSegment[sloped](I,H){\pmpn{\tkzUseLua{S.new.inradius}}}
\tkzLabelSegment[sloped](D,C){\pmpn{\tkzUseLua{S.new.side}}}
\end{tikzpicture}
```

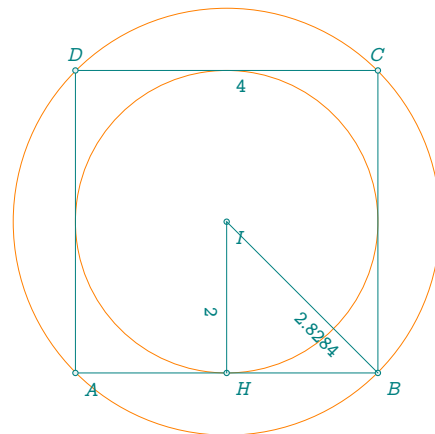

16.2 Square methods

Table 17: Square methods.

Methods	Comments
rotation (zi,za)	S.IA = square : rotation (z.I,z.A) <i>I</i> square center <i>A</i> first vertex
side (za,zb)	S.AB = square : side (z.A,z.B) AB is the first side (direct)

16.2.1 Square with side method

```

\directlua{%
  init_elements ()
  z.A      = point : new ( 0 , 0 )
  z.B      = point : new ( 2 , 1 )
  S.side   = square : side (z.A,z.B)
  z.B      = S.side.pb
  z.C      = S.side.pc
  z.D      = S.side.pd
  z.I      = S.side.center
}

\begin{tikzpicture}[scale = 2]
  \tkzGetNodes
  \tkzDrawPolygon(A,B,C,D)
  \tkzDrawPoints(A,B,C,D)
  \tkzLabelPoints(A,B)
  \tkzLabelPoints[above](C,D)
  \tkzDrawPoints[red](I)
\end{tikzpicture}

```

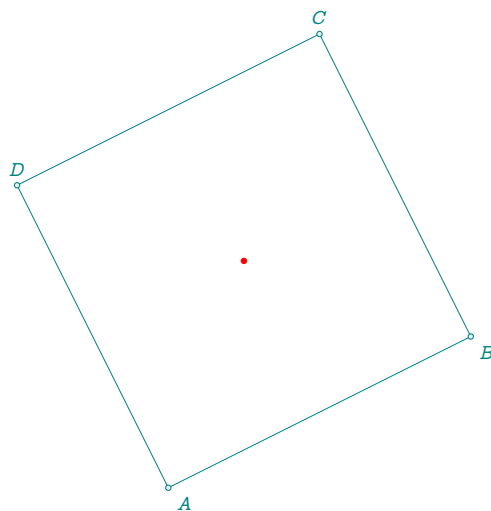

17 Class rectangle

17.1 Rectangle attributes

Points are created in the direct direction. A test is performed to check whether the points form a rectangle, otherwise compilation is blocked.

```
Creation R.ABCD = rectangle : new (z.A,z.B,z.C,z.D)
```

Table 18: rectangle attributes.

Attributes	Application	
pa	<code>z.A = R.ABCD.pa</code>	
pb	<code>z.B = R.ABCD.pb</code>	
pc	<code>z.C = R.ABCD.pc</code>	
pd	<code>z.D = R.ABCD.pd</code>	
type	<code>R.ABCD.type= 'rectangle'</code>	
center	<code>z.I = R.ABCD.center</code>	center of the rectangle
length	<code>R.ABCD.length</code>	the length
width	<code>R.ABCD.width</code>	the width
diagonal	<code>R.ABCD.diagonal</code>	diagonal length
ab	<code>R.ABCD.ab</code>	line passing through two vertices
ac	<code>R.ABCD.ca</code>	idem.
ad	<code>R.ABCD.ad</code>	idem.
bc	<code>R.ABCD.bc</code>	idem.
bd	<code>R.ABCD.bd</code>	idem.
cd	<code>R.ABCD.cd</code>	idem.

17.1.1 Example

```
\directlua{%
init_elements ()
z.A = point : new ( 0 , 0 )
z.B = point : new ( 4 , 0 )
z.C = point : new ( 4 , 4 )
z.D = point : new ( 0 , 4 )
R.new = rectangle : new (z.A,z.B,z.C,z.D)
z.I = R.new.center
}

\begin{tikzpicture}
\tkzGetNodes
\tkzDrawPolygon(A,B,C,D)
\tkzDrawPoints(A,B,C,D)
\tkzLabelPoints(A,B)
\tkzLabelPoints[above](C,D)
\tkzDrawPoints[red](I)
\end{tikzpicture}
```

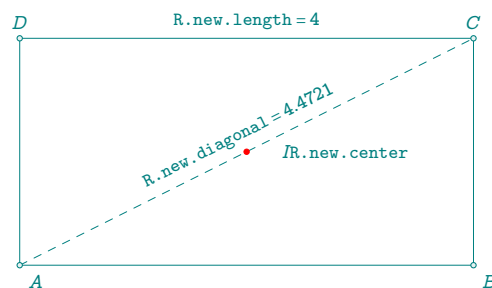

17.2 Rectangle methods

Table 19: Rectangle methods.

Methods	Comments
angle (zi,za,angle)	R.ang = rectangle : angle (z.I,z.A);z.A vertex; ang angle between 2 vertices
gold (za,zb)	R.gold = rectangle : gold (z.A,z.B) length/width = ϕ
diagonal (za,zc)	R.diag = rectangle : diagonal (z.I,z.A) I square center A first vertex
side (za,zb,d)	S.IA = rectangle : side (z.I,z.A) I square center A first vertex
get_lengths ()	S.IA = rectangle : get_lengths () I square center A first vertex

17.2.1 Angle method

```
\directlua{%
init_elements ()
z.A = point : new ( 0 , 0 )
z.B = point : new ( 4 , 0 )
z.I = point : new ( 4 , 3 )
P.ABCD = rectangle : angle ( z.I , z.A , math.pi/6)
z.B = P.ABCD.pb
z.C = P.ABCD.pc
z.D = P.ABCD.pd
}
```

```
\begin{tikzpicture}[scale = .5]
\tkzGetNodes
\tkzDrawPolygon(A,B,C,D)
\tkzDrawPoints(A,B,C)
\tkzLabelPoints(A,B,C,D)
\tkzDrawPoints[new](I)
\end{tikzpicture}
```

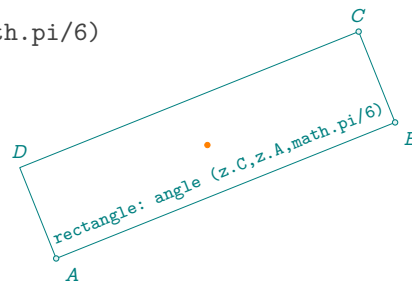

17.2.2 Side method

```
\directlua{%
init_elements ()
z.A = point : new ( 0 , 0 )
z.B = point : new ( 4 , 3 )
R.side = rectangle : side (z.A,z.B,3)
z.C = R.side.pc
z.D = R.side.pd
z.I = R.side.center
}
```

```
\begin{tikzpicture}
\tkzGetNodes
\tkzDrawPolygon(A,B,C,D)
\tkzDrawPoints(A,B,C,D)
\tkzLabelPoints(A,B)
\tkzLabelPoints[above](C,D)
\tkzDrawPoints[red](I)
\end{tikzpicture}
```

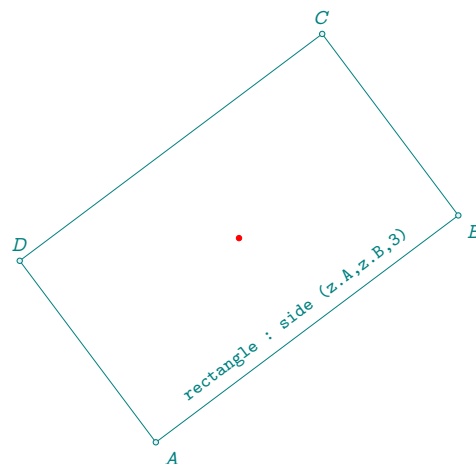

17.2.3 Diagonal method

```

\directlua{%
init_elements ()
z.A      = point : new ( 0 , 0 )
z.C      = point : new ( 4 , 3 )
R.diag   = rectangle : diagonal (z.A,z.C)
z.B      = R.diag.pb
z.D      = R.diag.pd
z.I      = R.diag.center
}

```

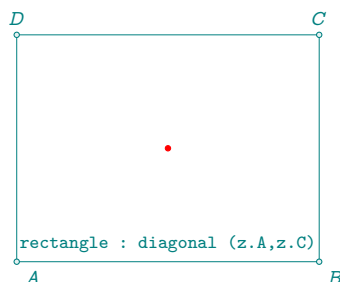

```

\begin{tikzpicture}
\tkzGetNodes
\tkzDrawPolygon(A,B,C,D)
\tkzDrawPoints(A,B,C,D)
\tkzLabelPoints(A,B)
\tkzLabelPoints[above](C,D)
\tkzDrawPoints[red](I)
\tkzLabelSegment[sloped,above](A,B){|rectangle : diagonal (z.A,z.C)|}
\end{tikzpicture}

```

17.2.4 Gold method

```

\directlua{%
init_elements ()
z.X      = point : new ( 0 , 0 )
z.Y      = point : new ( 4 , 2 )
R.gold   = rectangle : gold (z.X,z.Y)
z.Z      = R.gold.pc
z.W      = R.gold.pd
z.I      = R.gold.center
}

```

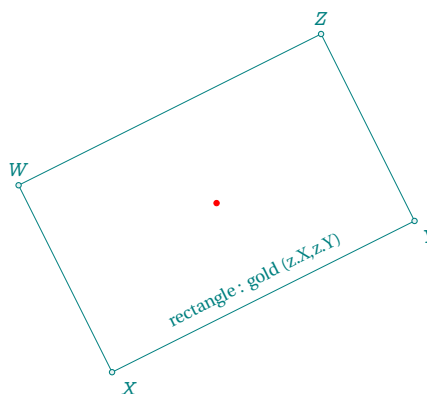

```

\begin{tikzpicture}
\tkzGetNodes
\tkzDrawPolygon(X,Y,Z,W)
\tkzDrawPoints(X,Y,Z,W)
\tkzLabelPoints(X,Y)
\tkzLabelPoints[above](Z,W)
\tkzDrawPoints[red](I)
\tkzLabelSegment[sloped,above](X,Y){rectangle : gold (z.X,z.Y)}
\end{tikzpicture}

```

18 Class parallelogram

18.1 Parallelogram attributes

Points are created in the direct direction. A test is performed to check whether the points form a parallelogram, otherwise compilation is blocked.

```
Creation P.new = parallelogram : new (z.A,z.B,z.C,z.D)
```

Table 20: Parallelogram attributes.

Attributes	Application	
pa	z.A = P.new.pa	
pb	z.B = P.new.pb	
pc	z.C = P.new.pc	
pd	z.D = P.new.pd	
type	P.new.type= 'parallelogram'	
i	z.I = P.new.i	intersection of diagonals
ab	P.new.ab	line passing through two vertices
ac	P.new.ca	idem.
ad	P.new.ad	idem.
bc	P.new.bc	idem.
bd	P.new.bd	idem.
cd	P.new.cd	idem.

18.1.1 Example: attributes

```
\directlua{%
init_elements ()
z.A      = point : new ( 0 , 0 )
z.B      = point : new ( 4 , 1 )
z.C      = point : new ( 7 , 5 )
z.D      = point : new ( 3 , 4 )
P.new    = parallelogram : new (z.A,z.B,z.C,z.D)
z.B      = P.new.pb
z.C      = P.new.pc
z.D      = P.new.pd
z.I      = P.new.center
}
\begin{tikzpicture}
\tkzGetNodes
\tkzDrawPolygon(A,B,C,D)
\tkzDrawPoints(A,B,C,D)
\tkzLabelPoints(A,B)
\tkzLabelPoints[above](C,D)
\tkzDrawPoints[red](I)
\end{tikzpicture}
```

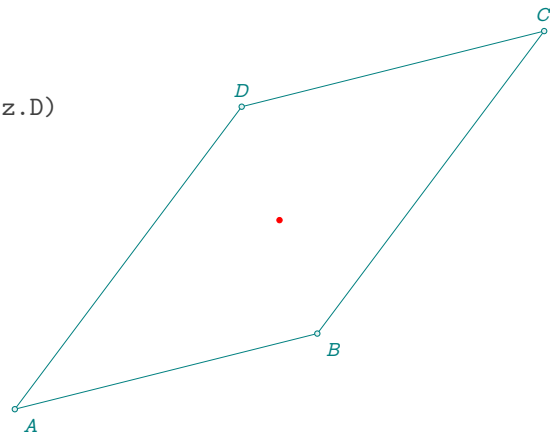

18.2 Parallelogram methods

Table 21: Parallelogram methods.

Methods	Comments
fourth (za,zb,zc)	completes a triangle by parallelogram (Refer to next example)

18.2.1 Parallelogram with fourth method

```

\directlua{%
init_elements ()
z.A      = point : new ( 0 , 0 )
z.B      = point : new ( 3 , 1 )
z.C      = point : new ( 4 , 3 )
P.four   = parallelogram : fourth (z.A,z.B,z.C)
z.D      = P.four.pd
z.I      = P.four.center
}
\begin{tikzpicture}[ scale = .75]
\tkzGetNodes
\tkzDrawPolygon(A,B,C,D)
\tkzDrawPoints(A,B,C,D)
\tkzLabelPoints(A,B)
\tkzLabelPoints[above](C,D)
\tkzDrawPoints[red](I)
\end{tikzpicture}

```

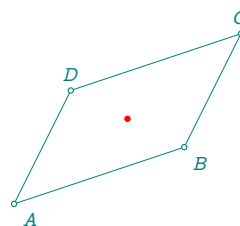

19 Class regular polygon

19.1 Regular_polygon attributes

```
Creation RP.IA = regular_polygon : new (z.I,z.A,6)
```

Table 22: Regular_polygon attributes.

Attributes	Application
center	$z.I = RP.IA.center$
vertices	array containing all vertex affixes
through	first vertex
circle	defines the circle with center I passing through A
type	$RP.IA.type = 'regular_polygon'$
side	$s = RP.IA.side$; $s =$ length of side
circumradius	$S.AB.circumradius$; radius of the circumscribed circle
inradius	$S.AB.inradius$; radius of the inscribed circle
proj	$RP.IA.proj$; projection of the center on one side
angle	$RP.IA.angle$; angle formed by the center and 2 consecutive vertices

19.1.1 Pentagon

```
\directlua{%
init_elements ()
z.O      = point:    new (0,0)
z.I      = point:    new (1,3)
z.A      = point:    new (2,0)
RP.five  = regular_polygon : new (z.I,z.A,5)
RP.five : name ("P_")
C.ins    = circle: radius (z.I,RP.five.inradius)
z.H      = RP.five.proj
}
\begin{tikzpicture}[scale = .75]
\def\nb{\tkzUseLua{RP.five.nb}}
\tkzGetNodes
\tkzDrawCircles(I,A I,H)
\tkzDrawPolygon(P_1,P_... ,P_\nb)
\tkzDrawPoints[red](P_1,P_... ,P_\nb,H,I)
\tkzLabelPoints[red](I,A,H)
\end{tikzpicture}
```

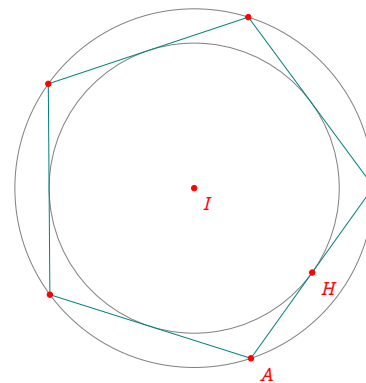

19.2 Regular_polygon methods

Table 23: regular_polygon methods.

Methods	Comments
$new(O,A,n)$	$RP.five = regular_polygon : new (z.I,z.A,5)$; I center A first vertex 5 sides
Circle	
$incircle ()$	$C.IH = RP.five : incircle ()$
Points	
$name (string)$	[19.1.1]

20 Class vector

In fact, they are more a class of oriented segments than vectors in the strict mathematical sense.

A vector is defined by giving two points (i.e. two affixes). `V.AB = vector : new (z.A,z.B)` creates the vector \vec{AB} , i.e. the oriented segment with origin A representing a vector. A few rudimentary operations are defined, such as sum, subtraction and multiplication by a scalar.

The sum is defined as follows:

Let $V.AB + V.CD$ result in a vector $V.AE$ defined as follows

If $\vec{CD} = \vec{BE}$ then $\vec{AB} + \vec{CD} = \vec{AB} + \vec{BE} = \vec{AE}$

```
Creation V.AB = vector: new (z.A,z.B)
```

```
z.A = ...
z.B = ...
z.C = ...
z.D = ...
V.AB = vector : new (z.A,z.B)
V.CD = vector : new (z.C,z.D)
V.AE = V.AB + V.CD % possible V.AB : add (V.CD)
z.E = V.AE.head % we recover the final point (head)
```

20.1 Attributes of a vector

Table 24: Vector attributes.

Attributes	Application	Example
tail	<code>V.AB.t = z.A</code>	[8.2.2]
head	<code>V.AB.head = z.B</code>	[8.2.2]
type	<code>V.AB.type = 'vector'</code>	
slope	<code>V.AB.slope</code>	[20.1.1]
length	<code>V.AB.norm</code>	[20.1.1]
mtx	<code>V.AB.mtx</code>	The result is a column matrix $\{\{V.AB.t\}, \{V.AB.h\}\}$

20.1.1 Example vector attributes

```

\directlua{%
init_elements ()
  z.O      = point: new (0,0)
  z.A      = point: new (0,1)
  z.B      = point: new (3,4)
  L.AB     = line : new ( z.A , z.B )
  z.C      = point: new (1,2)
  z.D      = point: new (2,1)
  u        = vector : new (z.A,z.B)
  v        = vector : new (z.C,z.D)
  w =u+v
  z.E = w.head
}
\begin{tikzpicture}[gridded]
  \tkzGetNodes
  \tkzLabelPoints(A,B,C,D,O,E)
  \tkzDrawSegments[->,red](A,B C,D A,E)
  \tkzLabelSegment(A,B){$\overrightarrow{u}$}
  \tkzLabelSegment(C,D){$\overrightarrow{v}$}
  \tkzLabelSegment(A,E){$\overrightarrow{w}$}
\end{tikzpicture}
$\overrightarrow{w}$ has slope :
$\tkzDN{\tkzUseLua{math.deg(w.slope)}}^\circ$

```

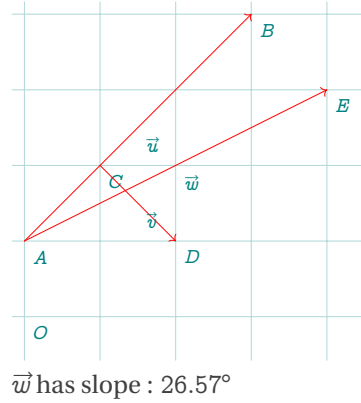

20.2 Methods of the class vector

Table 25: Methods of the class vector.

Metamethods	Application
<code>--add (u,v)</code>	$V.AB + V.CD$
<code>--sub (u,v)</code>	$V.AB - V.CD$
<code>--unm (u)</code>	$V.CD = -V.AB$
<code>--mul (k,u)</code>	$V.CD = k \cdot V.AB$
Methods	Application
<code>new(pt, pt)</code>	$V.AB = \text{vector: new (z.A,z.B)}$
<code>normalize(V)</code>	$V.AB : \text{normalize ()}$
<code>orthogonal(d)</code>	$V.AB : \text{orthogonal (d)}$
<code>scale(d)</code>	$V.CD = V.AB : \text{scale (2)}$ $\overrightarrow{CD} = 2\overrightarrow{AB}$
<code>at (V)</code>	$V.DB = V.AC : \text{at (z.D)}$ $\overrightarrow{DB} = \overrightarrow{AC}$

20.2.1 Example of methods

```

\directlua{%
  init_elements ()
  z.O = point: new (0,0)
  z.A = point: new (0,1)
  z.B = point: new (3,4)
  V.AB = vector: new (z.A,z.B)
  V.AC = V.AB : scale (.5)
  z.C = V.AC.head
  V.AD = V.AB : orthogonal ()
  z.D = V.AD.head
  V.AN = V.AB : normalize ()
  z.N = V.AN.head
  V.AR = V.AB : orthogonal(2*math.sqrt(2))
  z.R = V.AR.head
  V.AX = 2*V.AC - V.AR
  z.X = V.AX.head
  V.OY = V.AX : at (z.O)
  z.Y = V.OY.head
}
\begin{tikzpicture}[gridded,scale = .75]
  \tkzGetNodes
  \tkzDrawSegments[>=stealth,->,red](A,B A,C A,D A,N A,R A,X O,Y)
  \tkzLabelPoints(A,B,C,D,O,N,R,X,Y)
\end{tikzpicture}

```

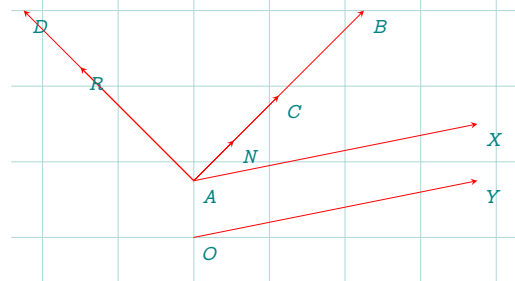

21 Class matrix

The `matrix` class is currently experimental, and its attribute and method names have not yet been finalized, indicating that this class is still evolving. Certain connections have been made with other classes, such as the `point` class. Additionally, a new attribute, `mtx`, has been included, associating a column matrix with the point, where the elements correspond to the point's coordinates in the original base. Similarly, an attribute has been added to the `vector` class, where `mtx` represents a column matrix consisting of the two affixes that compose the vector.

This `matrix` class has been created to avoid the need for an external library, and has been adapted to plane transformations. It allows you to use complex numbers.

☞ To display matrices, you'll need to load the `amsmath` package.

☞ While some methods are valid for any matrix size, the majority are reserved for square matrices of order 2 and 3.

21.1 Matrix creation

- The first method is: [21.5.1]

```
M = matrix: new ({a,b},{c,d})
or M = matrix: new {a,b},{c,d}
a, b, c, et d being real or complex numbers.
```

$$M = \begin{bmatrix} 3 & 5 \\ 4 & 4.02 \end{bmatrix}$$

- It is also possible to obtain a square matrix with: [21.5.7]

```
M = matrix : square (2,a,b,c,d)
```

- In the case of a column vector: [21.5.2]

```
V = matrix : vector (1,2,3)
```

$$V = \begin{bmatrix} 1 \\ 2 \\ 3 \end{bmatrix}$$

- Homogeneous transformation matrix [21.5.4]

The objective is to generate a matrix with homogeneous coordinates capable of transforming a coordinate system through rotation, translation, and scaling. To achieve this, it is necessary to define both the rotation angle, the coordinates of the new origin and the scaling factors.

```
H = matrix : htm (math.pi/3,1,2,2,1)
```

$$H = \begin{bmatrix} 1 & -0.87 & 1 \\ 0.87 & 0.50 & 2 \\ 0 & 0 & 1 \end{bmatrix}$$

21.2 Display a matrix: method print

This method (Refer to 21.5.8) is necessary to control the results, so here are a few explanations on how to use it. It can be used on real or complex matrices, square or not. A few options allow you to format the results. You need to load the `amsmath` package to use the "print" method. Without this package, it is possible to display the contents of the matrix without formatting with `print_array (M)`

```
\directlua{%
init_elements ()
M = matrix : new {{1,-1},{2,0}}
M : print ()
}
```

$$\begin{bmatrix} 1 & -1 \\ 2 & 0 \end{bmatrix}$$

21.3 Attributes of a matrix

Table 26: Matrix attributes.

Attributes	Application	
set	M.set = {{a,b},{c,d}}	table of tables
rows	M.rows	number of rows
cols	M.cols	number of columns
type	M.type = "matrix"	the type of object
det	M.det	determinant of a square matrix or nil

21.3.1 Attribute set

A simple array such as $\{\{1, 2\}, \{2, -1\}\}$ is often considered a "matrix". In "tkz-elements", we'll consider M defined by `matrix : new ({{1, 1}, {0, 2}})` as a matrix and M.set as an array (M.set = $\{\{1, 1\}, \{0, 2\}\}$).

You can access a particular element of the matrix, for example: M.set [2] [1] gives 0.

`\tkzUseLua{M.set [2] [1]}` is the expression that displays 2.

The number of rows is accessed with M.rows and the number of columns with M.cols, here's an example:

```
\directlua{%
init_elements ()
M = matrix : new ({{1,2,3},{4,5,6}})
M : print ()
tex.print("Rows: " .. M.rows)
tex.print("Cols: " .. M.cols)
}
```

$$\begin{bmatrix} 1 & 2 & 3 \\ 4 & 5 & 6 \end{bmatrix} \text{Rows: 2 Cols: 3}$$

21.3.2 Determinant with real numbers

The matrix must be square. This library was created for matrices of dimension 2 or 3, but it is possible to work with larger sizes. det is an attribute of the "matrix" object, but the determinant can also be obtained with the function `determinant(M)`.

```
\directlua{%
init_elements ()
M = matrix : square (3,1,1,0,2,-1,-2,1,-1,2)
M : print ()
tex.print ('\\ \\ \\')
tex.print ("Its determinant is: " .. M.det)
}
```

$$\begin{bmatrix} 1 & 1 & 0 \\ 2 & -1 & -2 \\ 1 & -1 & 2 \end{bmatrix}$$

Its determinant is: -10.0

21.3.3 Determinant with complex numbers

```
\directlua{%
init_elements ()
a = point :new (1,-2)
b = point :new (0,1)
c = point :new (1,1)
d = point :new (1,-1)
A = matrix : new ({{a, b}, {c,d}})
tex.print(tostring(A.det))
}
```

-4.00i

21.4 Metamethods for the matrices

Conditions on matrices must be valid for certain operations to be possible.

Table 27: Matrix metamethods.

Metamethods	Application
<code>__add(M1,M2)</code>	$M1 + M2$
<code>__sub(M1,M2)</code>	$M1 - M2$
<code>__unm(M)</code>	$- M$
<code>__mul(M1,M2)</code>	$M1 * M2$
<code>__pow(M,n)</code>	$M ^ n$ n integer $>$ or $<$ 0 or 'T'
<code>__tostroing(M,n)</code>	<code>tex.print(tostring(M))</code> displays the matrix
<code>__eq(M1,M2)</code>	true or false

21.4.1 Addition and subtraction of matrices

To simplify the entries, I've used a few functions to simplify the displays.

```
\directlua{%
init_elements ()
  A = matrix : new ({1,2},{2,-1})
  B = matrix : new ({-1,0},{1,3})
  S = A + B
  D = A - B
  dsp(A,'A')
  nl() nl()
  dsp(B,'B')
  nl() nl()
  dsp(S,'S') sym(" = ") dsp(A) sym(' + ') dsp(B)
  nl() nl()
  dsp(D,'D') sym(" = ") dsp(A) sym(' - ') dsp(B)
}
```

$$A = \begin{bmatrix} 1 & 2 \\ 2 & -1 \end{bmatrix}$$

$$B = \begin{bmatrix} -1 & 0 \\ 1 & 3 \end{bmatrix}$$

$$S = \begin{bmatrix} 0 & 2 \\ 3 & 2 \end{bmatrix} = \begin{bmatrix} 1 & 2 \\ 2 & -1 \end{bmatrix} + \begin{bmatrix} -1 & 0 \\ 1 & 3 \end{bmatrix}$$

$$D = \begin{bmatrix} 2 & 2 \\ 1 & -4 \end{bmatrix} = \begin{bmatrix} 1 & 2 \\ 2 & -1 \end{bmatrix} - \begin{bmatrix} -1 & 0 \\ 1 & 3 \end{bmatrix}$$

21.4.2 Multiplication and power of matrices

To simplify the entries, I've used a few functions. You can find their definitions in the sources section of this documentation.

```
\directlua{%
init_elements ()
  A = matrix : new ({1,2},{2,-1})
  B = matrix : new ({-1,0},{1,3})
  P = A * B
  I = A^-1
  C = A^3
  K = 2 * A
  T = A^'T'
}
```

$$P = \begin{bmatrix} 1 & 6 \\ -3 & -3 \end{bmatrix} = \begin{bmatrix} 1 & 2 \\ 2 & -1 \end{bmatrix} * \begin{bmatrix} -1 & 0 \\ 1 & 3 \end{bmatrix}$$

$$A^{-1} = \begin{bmatrix} 0.20 & 0.40 \\ 0.40 & -0.20 \end{bmatrix}$$

$$K = \begin{bmatrix} 2 & 4 \\ 4 & -2 \end{bmatrix}$$

$$A^T = \begin{bmatrix} 1 & 2 \\ 2 & -1 \end{bmatrix}$$

21.4.3 Metamethod eq

Test whether two matrices are equal or identical.

21.5 Methods of the class matrix

Table 28: Matrix methods.

Functions	Comments
<code>new(...)</code>	<code>M = matrix : new ({1,2},{2,-1})</code>
<code>square()</code>	<code>M = matrix : square (2,1,2,2,-1)</code>
<code>vector()</code>	<code>M = matrix : vector (2,1)</code>
<code>htm()</code>	<code>M = matrix : htm (2,1,2,2,-1)</code>
Methods	Comments
<code>print(s,n)</code>	<code>M : print ()</code> s='matrix' or ... default 'bmatrix'
<code>htm_apply(...)</code>	<code>M : htm_apply (...)</code>
<code>get()</code>	<code>M : get (i,j)</code> i = rows , j = cols Refer to 21.5.10
<code>inverse()</code>	<code>M : inverse ()</code>
<code>adjugate()</code>	<code>M : adjugate ()</code>
<code>transpose()</code>	<code>M : transpose ()</code>
<code>is_diagonal()</code>	true or false result :boolean
<code>is_orthogonal()</code>	true or false
<code>homogenization()</code>	<code>M : homogenization ()</code>

21.5.1 Function new

This is the main method for creating a matrix. Here's an example of a 2x3 matrix with complex coefficients:

```
\directlua{%
init_elements ()
  a = point : new (1,0)
  b = point : new (1,1)
  c = point : new (-1,1)
  d = point : new (0,1)
  e = point : new (1,-1)
  f = point : new (0,-1)
  M = matrix : new ({a,b,c},{d,e,f})
  M : print ()
}
```

$$\begin{bmatrix} 1 & 1+i & -1+i \\ i & 1-i & i \end{bmatrix}$$

21.5.2 Function vector

The special case of a column matrix, frequently used to represent a vector, can be treated as follows:

```
\directlua{%
init_elements ()
  M = matrix : vector (1,2,3)
  M : print ()
}
```

$$\begin{bmatrix} 1 \\ 2 \\ 3 \end{bmatrix}$$

21.5.3 Method homogenization

homogenization of vector: the aim is to be able to use a homogeneous transformation matrix

Let's take a point A such that `z.A = point : new (2,-1)`. In order to apply a `htm` matrix, we need to perform a few operations on this point. The first is to determine the vector (matrix) associated with the point. This is straightforward, since there's a point attribute called `mtx` which gives this vector:

```
z.A = point : new (2,-1)
V = z.A.mtx : homogenization ()
```

which gives:

```

\directlua{%
init_elements ()
  pi = math.pi
  M = matrix : htm (pi/4 , 3 , 1)
  z.A = point : new (2,-1)
  V = z.A.mtx : homogenization ()
  z.A.mtx : print ()
  tex.print ('then after homogenization: ')
  V : print ()
}

```

$$\begin{bmatrix} 2 \\ -1 \end{bmatrix} \text{ then after homogenization: } \begin{bmatrix} 2 \\ -1 \\ 1 \end{bmatrix}$$

21.5.4 Function htm: homogeneous transformation matrix

There are several ways of using this transformation. First, we need to create a matrix that can associate a rotation with a translation.

The main method is to create the matrix:

```

pi = math.pi
M = matrix : htm (pi/4 , 3 , 1)

```

A 3x3 matrix is created which combines a $\pi/4$ rotation and a $\vec{t} = (3, 1)$ translation.

$$\begin{bmatrix} 0.71 & -0.71 & 3 \\ 0.71 & 0.71 & 1 \\ 0 & 0 & 1 \end{bmatrix}$$

Now we can apply the matrix M. Let A be the point defined here: 21.5.3. By homogenization, we obtain the column matrix V .

```

W = A * V

```

$$\begin{bmatrix} 0.71 & -0.71 & 3 \\ 0.71 & 0.71 & 1 \\ 0 & 0 & 1 \end{bmatrix} \begin{bmatrix} 2 \\ -1 \\ 1 \end{bmatrix} = \begin{bmatrix} 5.12 \\ 1.71 \\ 1 \end{bmatrix}$$

All that remains is to extract the coordinates of the new point.

21.5.5 Method get_htm_point

In the previous section, we obtained the W matrix. Now we need to obtain the point it defines. The method `get_htm_point` extracts a point from a vector obtained after applying a `htm` matrix.

```

\directlua{%
init_elements ()
  W : print ()
  z.P = get_htm_point(W)
  tex.print("The affix of $$$ is: ")
  tex.print(display(z.P))
}

```

$$\begin{bmatrix} 5.12 \\ 1.71 \\ 1 \end{bmatrix} \text{ The affix of } P \text{ is: } 5.12+1.71i$$

21.5.6 Method htm_apply

The above operations can be simplified by using the `htm_apply` method directly at point A .

```

z.Ap = M: htm_apply (z.A)

```

Then the method `htm_apply` transforms a point, a list of points or an object.

```

\directlua{%
init_elements ()
  pi      = math.pi
  M       = matrix : htm (pi/4 , 3 , 1 )
  z.O     = point : new (0,0)
  V.ori   = z.O.mtx : homogenization ()
  z.I     = point : new (1,0)
  z.J     = point : new (0,1)
  z.A     = point : new (2,0)
  z.B     = point : new (1,2)
  L.AB    = line : new (z.A,z.B)
  z.Op,
  z.Ip,
  z.Jp    = M : htm_apply (z.O,z.I,z.J)
  L.ApBp  = M : htm_apply (L.AB)
  z.Ap    = L.ApBp.pa
  z.Bp    = L.ApBp.pb
  z.K     = point : new (2,2)
  T       = triangle : new ( z.I , z.J , z.K )
  Tp      = M : htm_apply (T)
  z.Kp    = Tp.pc
}

```

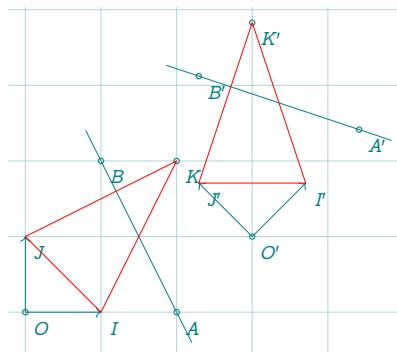

New cartesian coordinates system:

```

\directlua{%
init_elements ()
  pi = math.pi
  tp = tex.print
  nl = '\\\\'
  a = point(1,0)
  b = point(0,1)
  R = matrix : htm (pi/5,2,1)
  R : print () tp(nl)
  v = matrix : vector (1,2)
  v : print ()
  v.h = v : homogenization ()
  v.h : print () tp(nl)
  V = R * v.h
  V : print ()
  z.N = get_htm_point(V)
  tex.print(display(z.N))
}

```

$$\begin{bmatrix} 0.81 & -0.59 & 2 \\ 0.59 & 0.81 & 1 \\ 0 & 0 & 1 \end{bmatrix}$$

$$\begin{bmatrix} 1 \\ 2 \\ 1 \end{bmatrix}$$

$$\begin{bmatrix} 1.63 \\ 3.21 \\ 1 \end{bmatrix} 1.63+3.21i$$

21.5.7 Function square

We have already seen this method in the presentation of matrices. We first need to give the order of the matrix, then the coefficients, row by row.

```

\directlua{%
init_elements ()
M = matrix : square (2,2,3,-5,4)
M : print ()
}

```

$$\begin{bmatrix} 2 & 3 \\ -5 & 4 \end{bmatrix}$$

21.5.8 Method print

With the `amsmath` package loaded, this method can be used. By default, the `bmatrix` environment is selected, although you can choose from `matrix`, `pmatrix`, `Bmatrix`, `vmatrix`, `Vmatrix`. Another option lets you set the

number of digits after the decimal point. The "tkz_dc" global variable is used to set the number of decimal places. Here's an example:

```
\directlua{%
init_elements ()
  M = matrix : new ({math.sqrt(2),math.sqrt(3)},{math.sqrt(4),math.sqrt(5)})
  M : print ('pmatrix')
}

$$\begin{pmatrix} 1.414 & 1.732 \\ 2 & 2.236 \end{pmatrix}$$

```

You can also display the matrix as a simple array using the `print_array (M)` function. refer to the next example. In the case of a square matrix, it is possible to transmit a list of values whose first element is the order of the matrix.

```
\directlua{%
init_elements ()
  M = matrix : square (2,1,0,0,2)
  M : print ()
}

$$\begin{bmatrix} 1 & 0 \\ 0 & 2 \end{bmatrix}$$

```

21.5.9 Display a table or array: function `print_array`

We'll need to display results, so let's look at the different ways of displaying them, and distinguish the differences between arrays and matrices.

Below, A is an array. It can be displayed as a simple array or as a matrix, but we can't use the attributes and `A : print ()` is not possible because A is not an object of the class `matrix`. If you want to display an array like a matrix you can use the function `print_matrix` (refer to the next example).

```
\directlua{%
init_elements ()
  A = {{1,2},{1,-1}}
  tex.print ('A = ') print_array (A)
  tex.print (' or ')
  print_matrix (A)
  M = matrix : new ({1,1},{0,2})
  tex.print ('\\\\\\')
  tex.print ('M = ') M : print ()
}

$$A = \{ \{ 1, 2 \}, \{ 1, -1 \} \} \text{ or } \begin{bmatrix} 1 & 2 \\ 1 & -1 \end{bmatrix}$$

$$M = \begin{bmatrix} 1 & 1 \\ 0 & 2 \end{bmatrix}$$

```

21.5.10 Get an element of a matrix: method `get`

```
\directlua{%
init_elements ()
  M = matrix : new {{1,2},{2,-1}}
  S = M: get(1,1) + M: get(2,2)
  tex.print(S)
}
0
```

21.5.11 Inverse matrix: : method `inverse`

```
\directlua{%
init_elements ()
  A = matrix : new ({1,2},{2,-1})
  tex.print("Inverse of $A = $")
  B = A : inverse ()
  B : print ()
}
Inverse of  $A = \begin{bmatrix} 0.429 & 0.286 \\ 0.286 & -0.143 \end{bmatrix}$ 
```

21.5.12 Inverse matrix with power syntax

```
\directlua{%
init_elements ()
  M = matrix : new ({1,0,1},{1,2, 1},{0,-1,2})
  tex.print("$M = $") print_matrix (M)
  tex.print('\\\\')
  tex.print("Inverse of $M = M^{-1} = $")
  print_matrix (M^{-1})
}
```

$$M = \begin{bmatrix} 1 & 0 & 1 \\ 1 & 2 & 1 \\ 0 & -1 & 2 \end{bmatrix} \quad \text{Inverse of } M = M^{-1} = \begin{bmatrix} 1.250 & -0.250 & -0.500 \\ -0.500 & 0.500 & 0 \\ -0.250 & 0.250 & 0.500 \end{bmatrix}$$

21.5.13 Transpose matrix: method transpose

A transposed matrix can be accessed with A: transpose () or with A^{'T'}.

```
\directlua{%
init_elements ()
  A = matrix : new ({1,2},{2,-1})
  AT = A : transpose ()
  tex.print("$A^{'T'} = $")
  AT : print ()
}
```

$$A^{T'} = \begin{bmatrix} 1 & 2 \\ 2 & -1 \end{bmatrix}$$

Remark: (A^{'T'})^{'T'} = A

21.5.14 Method method adjugate

```
\directlua{%
init_elements ()
  N = matrix : new {{1, 0, 3},{2, 1, 0},{-1, 2, 0}}
  tex.print('N = ') print_matrix(N)
  tex.print('\\\\')
  N.a = N : adjugate ()
  N.i = N * N.a
  tex.print('adj(N) = ') N.a : print ()
  tex.print('\\\\')
  tex.print('N $\times$ adj(N) = ') print_matrix(N.i)det(N) = 15.0
  tex.print('\\\\')
  tex.print('det(N) = ') tex.print(N.det)
}
```

$$N = \begin{bmatrix} 1 & 0 & 3 \\ 2 & 1 & 0 \\ -1 & 2 & 0 \end{bmatrix} \quad \text{adj}(N) = \begin{bmatrix} 0 & 6 & -3 \\ 0 & 3 & 6 \\ 5 & -2 & 1 \end{bmatrix}$$

$$N \times \text{adj}(N) = \begin{bmatrix} 15 & 0 & 0 \\ 0 & 15 & 0 \\ 0 & 0 & 15 \end{bmatrix}$$

21.5.15 Method method identity

Creating the identity matrix order 3

```
\directlua{%
init_elements ()
  Id_3 = matrix : identity (3)
  Id_3 : print ()
}
```

$$\begin{bmatrix} 1 & 0 & 0 \\ 0 & 1 & 0 \\ 0 & 0 & 1 \end{bmatrix}$$

21.5.16 Diagonalization: method diagonalize

For the moment, this method only concerns matrices of order 2.

```
\directlua{%
init_elements ()
A = matrix : new {{5,-3}, {6,-4}}
tex.print('A = ') A : print ()
D,P = A : diagonalize ()
tex.print('D = ') D : print ()
tex.print('P = ') P : print ()
R = P^(-1)*A*P
tex.print('\\\\\\')
tex.print('Test: $D = P^{-1}AP = $ ')
R : print ()
tex.print('\\\\\\')
tex.print('Verification: $P^{-1}P = $ ')
T = P^(-1)*P
T : print ()
}
```

$$A = \begin{bmatrix} 5 & -3 \\ 6 & -4 \end{bmatrix} D = \begin{bmatrix} 2 & 0 \\ 0 & -1 \end{bmatrix} P = \begin{bmatrix} 1 & 1 \\ 1 & 2 \end{bmatrix}$$

$$\text{Test: } D = P^{-1}AP = \begin{bmatrix} 2 & 0 \\ 0 & -1 \end{bmatrix}$$

$$\text{Verification: } P^{-1}P = \begin{bmatrix} 1 & 0 \\ 0 & 1 \end{bmatrix}$$

21.5.17 Method is_orthogonal

The method returns true if the matrix is orthogonal and false otherwise.

```
\directlua{%
init_elements ()
local cos = math.cos
local sin = math.sin
local pi = math.pi
A = matrix : new {{cos(pi/6),-sin(pi/6)}, {sin(pi/6),cos(pi/6)}}
A : print ()
bool = A : is_orthogonal ()
tex.print('\\\\\\')
if bool
then
tex.print("The matrix is orthogonal")
else
tex.print("The matrix is not orthogonal")
end
tex.print('\\\\\\')
tex.print('Test: $A^T = A^{-1}$ ?$')
print_matrix(transposeMatrix (A))
tex.print('=')
inv_matrix (A) : print ()
}
```

$$\begin{bmatrix} 0.866 & -0.500 \\ 0.500 & 0.866 \end{bmatrix}$$

The matrix is orthogonal

$$\text{Test: } A^T = A^{-1}? \begin{bmatrix} 0.866 & 0.500 \\ -0.500 & 0.866 \end{bmatrix} = \begin{bmatrix} 0.866 & 0.500 \\ -0.500 & 0.866 \end{bmatrix}$$

21.5.18 Method is_diagonal

The method returns true if the matrix is diagonal and false otherwise.

22 Math constants and functions

Table 29: Math constants and functions.

contants or functions	Comments
tkzphi	constant $\varphi = (1 + \mathit{math.sqrt}(5))/2$
tkzinvgphi	constant $1/\varphi = 1/\mathit{tkzphi}$
tkzsqrtphi	constant $\sqrt{\varphi} = \mathit{math.sqrt}(\mathit{tkzphi})$
length (a,b)	point.abs(a-b) [26.1]
islinear (z1,z2,z3)	Are the points aligned? $(z2-z1) \parallel (z3-z1)$?
isortho (z1,z2,z3)	$(z2-z1) \perp (z3-z1)$? boolean
get_angle (z1,z2,z3)	the vertex is z1 [22.11]
bisector (z1,z2,z3)	L.Aa = bisector (z.A,z.B,z.C) from A [22.11]
bisector_ext (z1,z2,z3)	L.Aa = bisector_ext (z.A,z.B,z.C) from A
altitude (z1,z2,z3)	altitude from z1
set_lua_to_tex (list)	set_lua_to_tex('a','n') defines \a and \n
value (v)	apply scale * value
real (v)	apply value /scale
angle_normalize (an)	to get a value between 0 and 2π
barycenter ({z1,n1},{z2,n2}, ...)	barycenter of list of points
solve_quadratic (a,b,c)	gives the solution of $ax^2 + bx + c = 0$ a,b,c real or complex [22.15.1]
midpoint (z1,z2)	midpoint of the segment [12.3.30]
midpoints (z1,z2,...,zn)	midpoints of z1z2, z2z3 etc. z1zn [25.5]

22.1 Length of a segment

`length(z.A,z.B)` is a shortcut for `point.abs(z.A-z.B)`. This avoids the need to use complexes. It's also a shortcut for `L.AB = line:new(z.A,z.B)` and `l = L.AB.length`. Depending on the context, you'll need to choose the most appropriate method.

22.2 Midpoint and midpoints

As with length, a shortcut is available, e.g. `z.M = midpoint(z.A,z.B)`. If a straight line is required, then use: `z.M = L.AB.mid`.

The aim here is to determine the midpoints of a polygon. For example, considering a triangle abc , we can obtain the middles of the sides, after defining the triangle `T.abc = triangle:new(z.a,z.b,z.c)`, the middles are the vertices of the medial triangle `z.ma,z.mb,z.mc = T.abc : medial()`.

`midpoints` is a shortcut for defining midpoints without using triangles:

```
z.mc,z.ma,z.mb = midpoints(z.a,z.b,z.c).
```

The medial triangle can be omitted with `z.mc,z.ma,z.mb = midpoints(get_points(T.abc))`.

22.3 Bisector

As shown in the previous table, `bisector (z1,z2,z3)` defines the bisector of vertex `z1`.

22.4 Barycenter

Explanations are given here: 24.4

22.5 Harmonic division with tkzphi

```
\directlua{%
  init_elements ()
  z.a = point: new(0,0)
  z.b = point: new(8,0)
  L.ab = line: new (z.a,z.b)
  z.m,z.n = L.ab: harmonic_both (tkzphi)
```

```

}
\begin{tikzpicture}[scale =.5]
  \tkzGetNodes
  \tkzDrawLine[add= .2 and .2](a,n)
  \tkzDrawPoints(a,b,n,m)
  \tkzLabelPoints(a,b,n,m)
\end{tikzpicture}

```



22.6 Function islinear or is_linear

```

\directlua{%
  init_elements ()
  z.a = point: new (1, 1)
  z.b = point: new (2, 2)
  z.c = point: new (4, 4)
  if islinear (z.a,z.b,z.c) then
    z.d = point: new (0, 0)
  else
    z.d = point: new (-1, -1)
  end
}
\begin{tikzpicture}
  \tkzGetNodes
  \tkzDrawPoints(a,...,d)
  \tkzLabelPoints(a,...,d)
\end{tikzpicture}

```

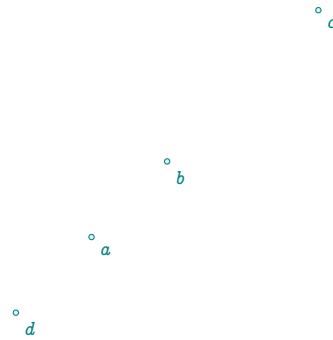

22.7 Function value

value to apply scaling if necessary

If `scale = 1.2` with `a = value(5)` the actual value of `a` will be $5 \times 1.2 = 6$.

22.8 Function real

If `scale = 1.2` with `a = 6` then `real(a) = 6/1.2 = 5`.

22.9 Transfer from lua to \TeX

It's possible to transfer variable from Lua to \TeX with the macro `\tkzUseLua`.

```

\directlua{%
init_elements ()
  z.A      = point : new (0 , 0)
  z.B      = point : new (3 , 2)
  z.C      = point : new (2 , 5)
  L.AB     = line  : new (z.A,z.B)
  d        = L.AB : distance (z.C)
  l        = L.AB : length
  z.H      = L.AB : projection (z.C)
}
\begin{tikzpicture}
\tkzGetNodes
\tkzDrawLines(A,B C,H)
\tkzDrawPoints(A,B,C,H)
\tkzLabelPoints(A,B,C,H)
\tkzLabelSegment[above right,draw] (C,H){$CH = \tkzUseLua{d}$}
\tkzLabelSegment[below right,draw] (A,B){$AB = \tkzUseLua{l}$}
\end{tikzpicture}

```

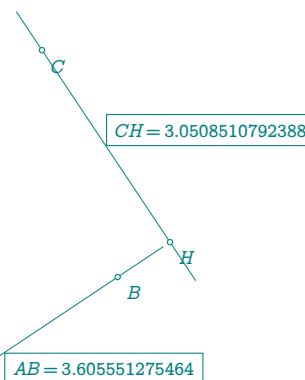

22.10 Normalized angles : Slope of lines (ab), (ac) and (ad)

```

\directlua{%
init_elements ()
  z.a      = point: new(0, 0)
  z.b      = point: new(-3, -3)
  z.c      = point: new(0, 3)
  z.d      = point: new(2, -2)
  angle    = point.arg (z.b-z.a)
  tex.print('slope of (ab) : '..tostring(angle)..'\\')
  tex.print('slope normalized of (ab) : '..tostring(angle\_normalize(angle))..'\\')
  angle    = point.arg (z.c-z.a)
  tex.print('slope of (ac) : '..tostring(angle)..'\\')
  tex.print('slope normalized of (ac) : '..tostring(angle\_normalize(angle))..'\\')
  angle    = point.arg (z.d-z.a)
  tex.print('slope of (ad) : '..tostring(angle)..'\\')
  tex.print('slope normalized of (ad) : '..tostring(angle\_normalize(angle))..'\\')
}

```

```

slope of (ab) : -2.3561944901923
slope normalized of (ab) : 3.9269908169872
slope of (ac) : 1.5707963267949
slope normalized of (ac) : 1.5707963267949
slope of (ad) : -0.78539816339745
slope normalized of (ad) : 5.4977871437821

```

```

\begin{tikzpicture}[scale = .75]
  \tkzGetNodes
  \tkzDrawLines[red](a,b a,c a,d)
  \tkzDrawPoints(a,b,c,d)
  \tkzLabelPoints(a,b,c,d)
\end{tikzpicture}

```

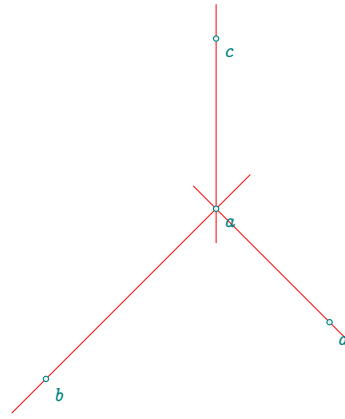

22.11 Get angle

The function `get_angle (a,b,c)` gives the angle normalized of (\vec{ab}, \vec{ac}) .

```

\directlua{%
init_elements ()
  z.a = point: new(0, 0)
  z.b = point: new(-2, -2)
  z.c = point: new(0, 3)
  angcb = tkzround ( get_angle (z.a,z.c,z.b),3)
  angbc = tkzround ( get_angle (z.a,z.b,z.c),3)
}

```

```

\begin{tikzpicture}
  \tkzGetNodes
  \tkzDrawLines[red](a,b a,c)
  \tkzDrawPoints(a,b,c)
  \tkzLabelPoints(a,b,c)
  \tkzMarkAngle[->](c,a,b)
  \tkzLabelAngle(c,a,b){\tkzUseLua{angcb}}
  \tkzMarkAngle[->](b,a,c)
  \tkzLabelAngle(b,a,c){\tkzUseLua{angbc}}
\end{tikzpicture}

```

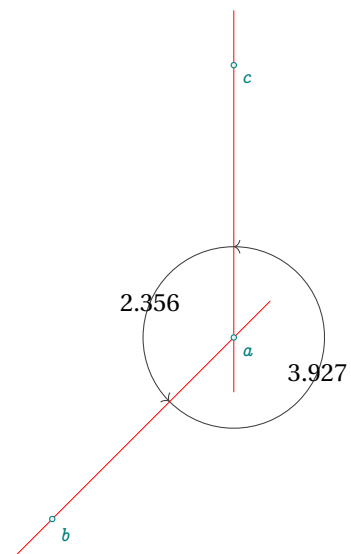

22.12 Dot or scalar product

```
\directlua{%
init_elements ()
  z.A = point: new(0,0)
  z.B = point: new(5,0)
  z.C = point: new(0,3)
  T.ABC = triangle: new (z.A,z.B,z.C)
  z.A_1,
  z.B_1,
  z.C_1 = get_points (T.ABC: anti ())
  x = dot_product (z.A,z.B,z.C)
}
```

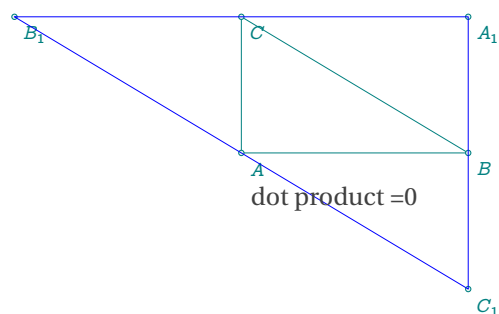

```
\begin{tikzpicture}
\tkzGetNodes
\tkzDrawPolygon(A,B,C)
\tkzDrawPoints(A,B,C,A_1,B_1,C_1)
\tkzLabelPoints(A,B,C,A_1,B_1,C_1)
\tkzDrawPolygon[blue](A_1,B_1,C_1)
\tkzText[right](0,-1){dot product =\tkzUseLua{x}}
\end{tikzpicture}
```

The scalar product of the vectors \overrightarrow{AC} and \overrightarrow{AB} is equal to 0, so these vectors are orthogonal.

22.13 Alignment or orthogonality

With the functions `islinear` and `isortho`. `islinear(z.a,z.b,z.c)` gives true idf the points a , b and c are aligned.

`isortho(z.a,z.b,z.c)` gives true if the line (ab) is orthogonal to the line (ac) .

22.14 Bisector and altitude

These functions are useful if you don't need to create a useful triangle object for the rest of your code.

```
\directlua{%
init_elements ()
  z.a = point: new (0, 0)
  z.b = point: new (5, -2)
  z.c = point: new (2, 3)
  z.i = bisector (z.a,z.c,z.b).pb
  z.h = altitude (z.b,z.a,z.c).pb
  angic = tkzround ( get_angle (z.a,z.i,z.c),2)
  angci = tkzround ( get_angle (z.a,z.b,z.i),2)
  z.e = bisector_ext (z.a,z.b,z.c).pb
}
```

```
\begin{tikzpicture}
\tkzGetNodes
\tkzDrawPolygon(a,b,c)
\tkzDrawSegments(a,i b,h a,e)
\tkzDrawPoints(a,b,c,i,h)
\tkzLabelPoints(a,b)
\tkzLabelPoints[above](c,i,h)
\tkzMarkAngle[->](i,a,c)
\tkzLabelAngle[font=\tiny,pos=.75](i,a,c){\tkzUseLua{angci}}
\tkzMarkAngle[-<](b,a,i)
\tkzLabelAngle[font=\tiny,pos=.75](b,a,i){\tkzUseLua{angic}}
\end{tikzpicture}
```

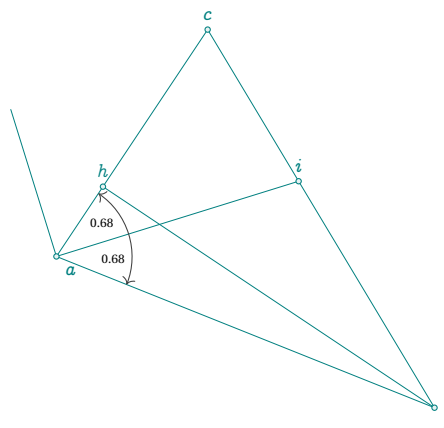

22.15 Other functions

Not documented because still in beta version: parabola, Cramer22, Cramer33.

22.15.1 Function solve_quadratic

This function solves the equation $ax^2 + bx + c = 0$ with real or complex numbers.

```
\directlua{%
init_elements ()
  tex.sprint('Solve :  $x^2+1=0$  The solution set is ')
  r1,r2 = solve_quadratic(1,0,1)
  tex.print('\{\}\{..\tostring(r1).. , '..tostring(r2)..'\}\}')
  tex.print('\{\}\{\}')
  tex.sprint('Solve :  $x^2+2x-3=0$  The solution set is ')
  r1,r2 = solve_quadratic(1,2,-3)
  tex.print('\{\}\{..\tostring(r1).. , '..tostring(r2)..'\}\}')
  tex.print('\{\}\{\}')
  a = point (0,1)
  b = point (1,1)
  c = point (-1,1)
  tex.sprint('Solve :  $ix^2+(1+i)x+(-1+i)=0$  The solution set is ')
  r1,r2 = solve_quadratic(a,b,c)
  tex.print('\{\}\{..\tostring(r1).. , '..tostring(r2)..'\}\}')
}
Solve :  $x^2 + 1 = 0$  The solution set is {false , false}
Solve :  $x^2 + 2x - 3 = 0$  The solution set is {1.0 , -3.0}
Solve :  $ix^2 + (1 + i)x + (-1 + i) = 0$  The solution set is {0.134-0.684i , -1.134+1.684i}
```

23 Intersections

It's an essential tool. For the moment, the classes concerned are lines, circles and ellipses, with the following combinations: line-line; line-circle; circle-circle and line-conic. Note that circles form a separate class from conics, which represent parabolas, hyperbolas and ellipses. The argument is a pair of objects, in any order. Results consist of one or two values, either points, boolean **false** or underscore **_**.

23.1 Line-line

The result is of the form: point or false.

```
\directlua{%
init_elements ()
  z.A = point : new (1,-1)
  z.B = point : new (4,1)
  z.C = point : new (2,1)
  z.D = point : new (4,-2)
  z.I = point : new (0,0)
  L.AB = line : new (z.A,z.B)
  L.CD = line : new (z.C,z.D)
  x = intersection (L.AB,L.CD)
  if x == false then
  tex.print('error')
  else
  z.I = x
  end
}
```

```
\begin{tikzpicture}
  \tkzGetNodes
  \tkzDrawSegments(A,B C,D)
  \tkzDrawPoints(A,B,C,D,I)
  \tkzLabelPoints(A,B,C,D,I)
\end{tikzpicture}
```

Other examples: 26.5, 26.6, 26.7

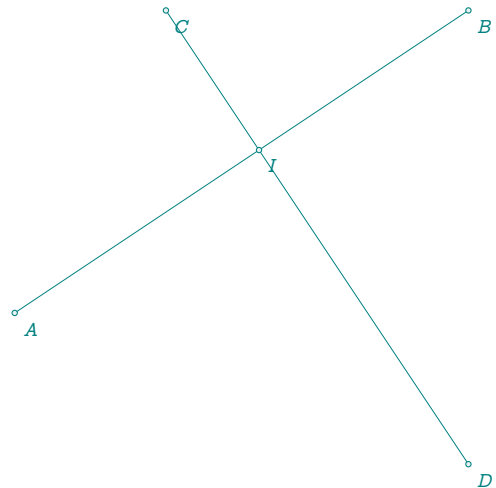

23.2 Line-circle

The result is of the form: point, point or false, false. If the line is tangent to the circle, then the two points are identical. You can ignore one of the points by using the underscore: _, point or point, _. When the intersection yields two solutions, the order of the points is determined by the argument of $(z.p - z.c)$ with c center of the circle and p point of intersection. The first solution corresponds to the smallest argument (arguments are between 0 and 2π).

```
\directlua{%
init_elements ()
  z.A = point : new (1,-1)
  z.B = point : new (1,2)
  L.AB = line : new (z.A,z.B)
  z.O = point : new (2,1)
  z.D = point : new (3,1)
  z.E = point : new (3,2)
  L.AE = line : new (z.A,z.E)
  C.OD = circle : new (z.O,z.D)
  z.I,_ = intersection (L.AB,C.OD)
  _,z.K = intersection (C.OD,L.AE)
}

\begin{tikzpicture}
\tkzGetNodes
  \tkzDrawLines(A,B A,E)
  \tkzDrawCircle(O,D)
  \tkzDrawPoints(A,B,O,D,I,K)
  \tkzLabelPoints[left] (A,B,O,D,I,K)
\end{tikzpicture}
Other examples: 26.5
```

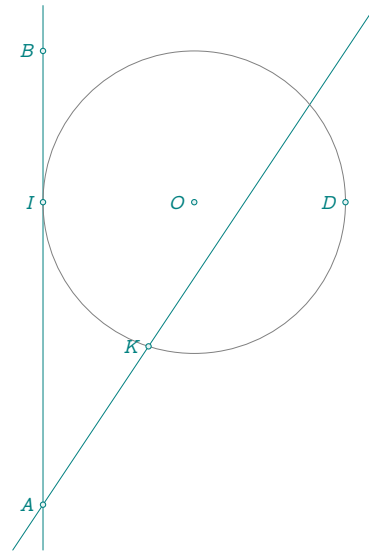

23.3 Circle-circle

The result is of the form : point , point or false , false. If the circles are tangent, then the two points are identical. You can ignore one of the points by using the underscore: `_` , point or point , `_`. As for the intersection of a line and a circle, consider the argument of `z.p-z.c` with `c` center of the first circle and `p` point of intersection. The first solution corresponds to the smallest argument (arguments are between 0 and 2π).

```
\directlua{%
init_elements ()
  z.A      = point : new (1,1)
  z.B      = point : new (2,2)
  z.C      = point : new (3,3)
  z.D      = point : new (3,0)
  C.AB     = circle : new (z.A,z.B)
  C.CB     = circle : new (z.C,z.B)
  z.I,_    = intersection (C.AB,C.CB)
  C.DC     = circle : new (z.D,z.C)
  z.J,z.K  = intersection (C.DC,C.CB)
}
```

```
\begin{tikzpicture}
  \tkzGetNodes
  \tkzDrawCircles(A,B C,B D,C)
  \tkzDrawPoints(A,I,C,D,J,K)
  \tkzLabelPoints(A,I,C,D,J,K)
\end{tikzpicture}
Other examples: 26.5, 4.3
```

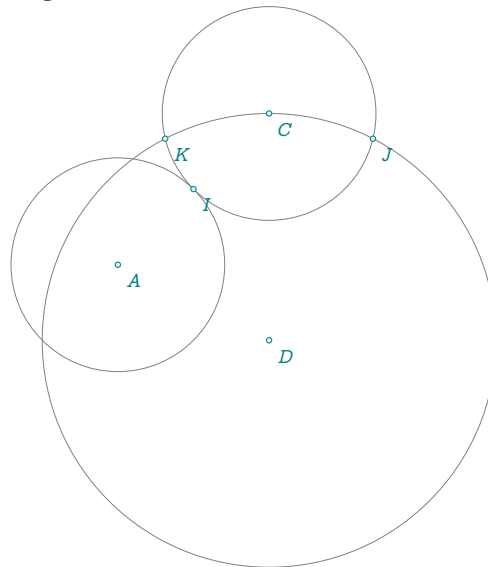

23.4 Line-conic

The following example is complex, but it shows the possibilities of Lua. The designation of intersection points is a little more complicated than the previous one, as the argument characterizing the major axis must be taken into account. The principle is the same, but this argument must be subtracted. In concrete terms, you need to consider the slopes of the lines formed by the center of the ellipse and the points of intersection, and the slope of the major axis.

```
\directlua{%
  init_elements ()
  z.a      = point: new (5 , 2)
  z.b      = point: new (-4 , 0)
  L.ab     = line : new (z.a,z.b)
  z.c      = L.ab.mid
  z.v      = L.ab: point (-.2)
  local a  = length (z.c,z.v)
  local c  = .5 * length(z.a, z.b)
  local e  = c / a
  z.K      = L.ab : report (a^2 / c, z.c)
  z.Kp     = (z.K-z.a) : orthogonal(2): at (z.K)
  L.dir    = line : new (z.K,z.Kp)
  EL       = conic: new (z.b,L.dir,e)
  curve    = EL : points (0,1,50)
  z.m      = point: new (2 , 4)
  z.n      = point: new (4 , 4)
  L.mn     = line : new (z.m,z.n)
  z.r,z.s  = intersection (EL,L.mn)
}
```

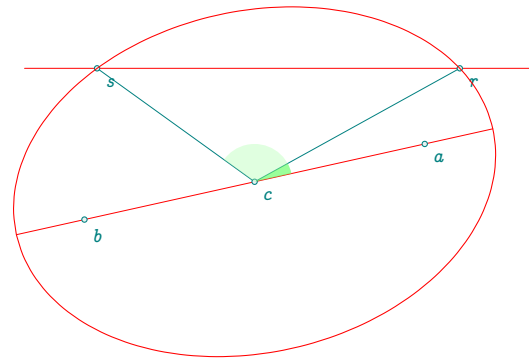

```
\begin{tikzpicture}[scale =.5]
  \tkzGetNodes
  \tkzDrawLines[red](a,b r,s)
  \tkzDrawSegments(c,r c,s)
  \tkzDrawPoints(a,b,c,r,s)
  \tkzLabelPoints(a,b,c,r,s)
  \tkzDrawCoordinates[smooth,red](curve)
  \tkzFillAngles[green!30,opacity=.4](v,c,s)
  \tkzFillAngles[green!80,opacity=.4](v,c,r)
\end{tikzpicture}
Other examples: 26.32
```

23.4.1 Intersection all subtypes of conics

```
\directlua{
  z.A      = point : new ( 0 , 0 )
  z.B      = point : new ( 4 , -2 )
  L.dir    = line : new (z.A,z.B)
  z.F      = point : new ( 2 , 2)
  CO1     = conic : new(z.F,L.dir,.8)
  CO2     = conic : new(z.F,L.dir, 1)
  CO3     = conic : new(z.F,L.dir, 1.2)
  curve1  = CO1 : points ( 0,1,50)
  curve2  = CO2 : points (-5,5,50)
  curve3  = CO3 : points (-5,5,50)
  z.K      = CO1.K
  z.u,z.v  = get_points(CO1.major_axis)
  z.x      = L.dir : report (-4,z.K)
  z.y      = L.dir : report ( 4,z.K)
}
```

```

z.r      = point : new ( 0 , 4 )
z.s      = point : new ( 4 , 1 )
L.rs     = line  : new (z.r,z.s)
z.u_1,z.u_2 = intersection (L.rs,C01)
z.v_1,z.v_2 = intersection (L.rs,C02)
z.w_1,z.w_2 = intersection (L.rs,C03)
}
\begin{tikzpicture}
\tkzGetNodes
\tkzDrawCoordinates[smooth](curve1)
\tkzDrawCoordinates[smooth](curve2)
\tkzDrawCoordinates[smooth](curve3)
\tkzDrawLines[add =.5 and .5](r,s u,v)
\tkzDrawLines(x,y)
\tkzDrawPoints[red](u_1,u_2,v_2,v_1,w_1,w_2)
\end{tikzpicture}

```

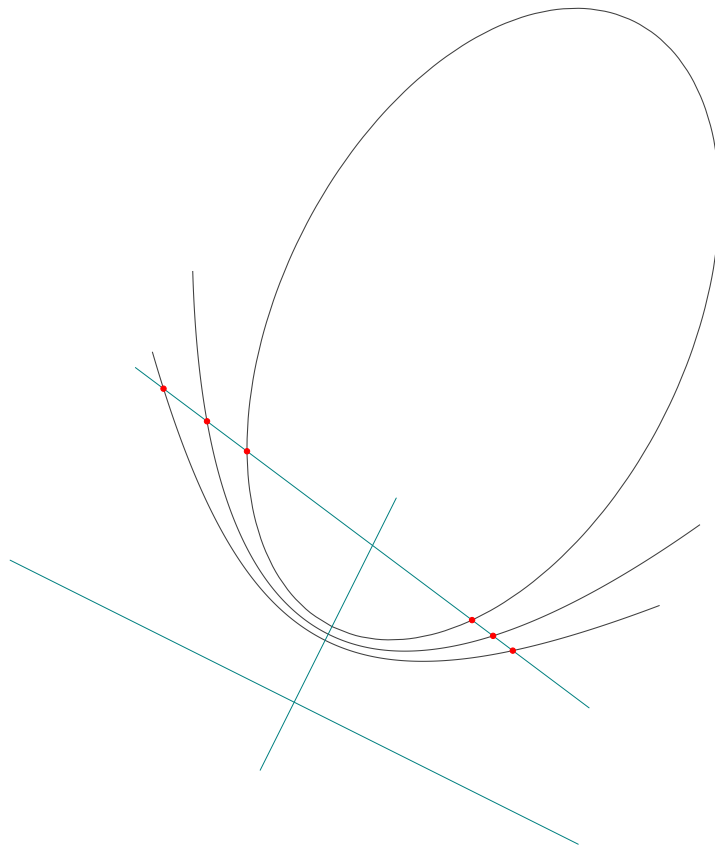

23.4.2 Intersection line-parabola, explained

In this example, we're looking for a parabola inscribed in a triangle, i.e. tangent to the triangle's three sides. I won't go into detail about the first part to obtain the parabola. You'll notice this line

```
L.euler = T : euler_line () : swap_line()
```

it swaps the ends of the Euler line, as we'll see later.

To construct the points of contact, it is necessary to find the intersections of the parabola with the sides:

```

z.ta    = intersection (PA,T.bc)
z.tb    = intersection (PA,T.ca)
z.tc    = intersection (PA,T.ab)

```

We will now detail how to determine the intersection of a line (ab) with the parabola. In this case, Euler's line serves as the directrix of the parabola. Its points have been swapped to maintain the correct order of abscissas—that is, negative values on the left and positive values on the right.

To simplify calculations, it is useful to change the coordinate system by setting the vertex of the parabola as the origin. The focal axis (`major_axis`), oriented from K to F , becomes the ordinate axis, while the abscissa axis is chosen so that the new system is `direct`.

I have kept `z.U = OCCS.x` and `z.V = OCCS.y` in the code to visualize the new coordinate system, for example, using `\tkzDrawSegments[red,->](S,U S,V)`. This new system is created with:

```
OCCS    = occs : new (L.KF,z.S)
```

The line (KF), the axis of symmetry of the parabola, becomes the ordinate axis. In this new coordinate system, the equation of the parabola is $y = \frac{x^2}{2p}$, where p is the distance KF , also known as the *latus rectum*.

The `coordinates` method of the `occs` class allows you to obtain the new coordinates of each point. The `param_line` function calculates the coefficients of the line's equation (this function is currently internal and its name may change). Then, `solve_para_line` is used to find the common points between the line and the parabola (again, this function is internal and subject to modification).

The result is two abscissas that must be placed on the axis passing through S and orthogonal to the focal axis. This is why it was important to position the curve correctly. If you remove `swap_line` for Euler's line, you will see that the curve becomes the reflection of the previous one. While the parabola remains unchanged overall, the intersection points will not.

Finally, the abscissas of the intersection points must be placed, and then the intersections of the lines orthogonal to Euler's line passing through these abscissas with the line (ab) must be determined.

Note: This geometric method is more appropriate than determining the intersection points' coordinates using formulas. Indeed, those coordinates would be expressed in the new coordinate system, requiring an additional transformation to return to the original system.

```

\directlua{%
  z.A    = point : new ( 0 , 0 )
  z.B    = point : new ( 6, 0 )
  z.C    = point : new ( 2, 3 )
  T      = triangle : new (z.A, z.B, z.C)
  L.euler = T : euler_line () : swap_line()
  z.F    = T : kimberling (110)
  z.H    = T.orthocenter
  z.O    = T.circumcenter
  z.Ω    = point : new (0,0)
  z.i    = point : new (1,0)
  z.j    = point : new (0,1)
  PA     = conic : new (z.F,L.euler,1)
  curve  = PA : points (-3.5,5.5,50)
  local p = PA.p
  z.K    = PA.K
  z.S    = midpoint(z.F,z.K)
  L.KF   = PA.major_axis
  z.ta   = intersection (PA,T.bc)
  z.tb   = intersection (PA,T.ca)
  z.tc   = intersection (PA,T.ab)
% new occs
OCCS    = occs : new (L.KF,z.S)

```

```

z.U      = OCCS.x
z.V      = OCCS.y
% line a,b
z.a      = point : new (3,6)
z.b      = point : new (8,-1)
L.ab     = line  : new (z.a,z.b)
% coordinates in the new occs
Xa,Ya    = OCCS : coordinates (z.a)
Xb,Yb    = OCCS : coordinates (z.b)
% solve in the new occs
local r,s = param_line (Xa,Ya,Xb,Yb)
r1,r2    = solve_para_line (p,r,s)
z.x      = OCCS.abcissa :report(r1,z.K)
z.y      = OCCS.abcissa :report(r2,z.K)
L1       = L.euler : ortho_from (z.x)
L2       = L.euler : ortho_from (z.y)
z._1    = intersection (L.ab,L1)
z._2    = intersection (L.ab,L2)
}
\begin{tikzpicture}
\tkzGetNodes
\tkzDrawCoordinates[smooth,purple,thick](curve)
\tkzDrawLines[add = .2 and 1](A,B A,C B,C K,F O,H)
\tkzDrawPolygon[thick,cyan](A,B,C)
\tkzDrawSegment[blue](a,b)
\tkzDrawPoints(F,K,H,S,O)
\tkzDrawPoints(A,B,F,K,S,ta,tb,tc)
\tkzDrawPoints[red,size=2](_1,_2)
\tkzLabelPoints[red,above](_1)
\tkzLabelPoints[red,right](_2)
\tkzLabelPoints(F,S,O,A,B)
\tkzLabelPoints[above](C)
\tkzLabelPoints[left](H,K)
\end{tikzpicture}

```

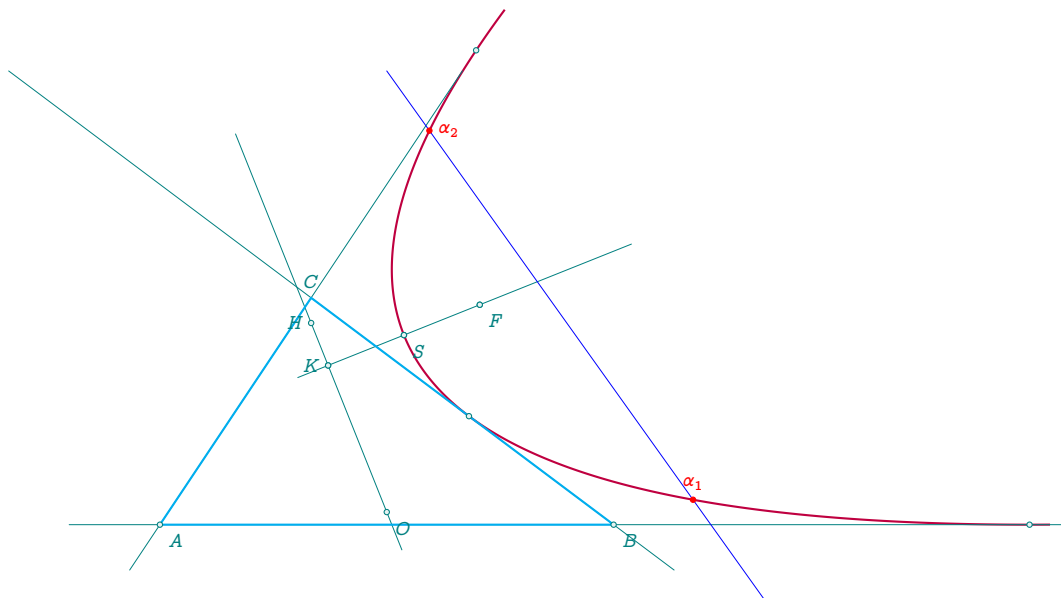

24 In-depth study

24.1 The tables

24.1.1 General tables

Tables are the only data structure "container" integrated in Lua. They are associative arrays which associates a key (reference or index) with a value in the form of a field (set) of key/value pairs. Moreover, tables have no fixed size and can grow based on our need dynamically.

Tables are created using table constructors, the simplest of which is the use of braces, e.g. `{}`. This defines an empty table.

```
F = {"banana", "apple", "cherry"}
```

`print(F[2])` -> pomme

qui peut être également défini par

```
FR = {[1] = "banana", [3] = "cherry", [2] = "apple"}
```

`print(FR[3])` -> cherry

`FR[4]`="orange"

```
print(#FR)
-- I for Index
for I,V in ipairs(FR) do
  print(I,V)
end
```

1 banana

2 apple

3 cherry

4 orange

```
C = {"banana" = "yellow" , ["apple"] = "green" , ["cherry"] = "red" }
C.orange = "orange"
```

```
for K,V in pairs (C) do
  print(K,V)
end
```

banana = yellow cherry = red orange = orange apple = green

Another useful feature is the ability to create a table to store an unknown number of function parameters, for example:

```
function ReturnTable (...)
  return table.pack (...)
end
```

```
function ParamToTable (...)
  mytab = ReturnTable(...)
  for i=1,mytab.n do
    print(mytab[i])
  end
end
ParamToTable("cherry","apple","orange")
```

Using tables with table[key] syntax:

```
C["banana"] and F[1]
```

But with string constants as keys we have the sugar syntax: C.banana but this syntax does not accept numbers. It's possible to erase a key/value pair from a table, with :

```
C.banana = nil
```

24.1.2 Table z

This is the most important table in the package. It stores all points and enables them to be transferred to TikZ. It is defined with `z = {}`, then each time we write

```
z.name = point : new ( a , b)
```

a point object is stored in the table. The key is name, the value is an object. We have seen that `z.name.re = a` and that `z.name.im = b`.

However, the elements of this table have essential properties.

For example, if you wish to display an element, then `tex.print(tostring(z.name)) = a+ib` the `tostring` operation displays the affix corresponding to the point.

In addition, we'll see that it's possible to perform operations with the elements of the z table.

24.2 Transfers

We've seen (sous-section 7.1.1) that the macro transfers point coordinates to TikZ. Let's take a closer look at this macro:

```
\def\tkzGetNodes{\directlua{%
  for K,V in pairs(z) do
    local K,n,sd,ft
    n = string.len(KS)
    if n > 1 then
      _,_,ft, sd = string.find( K , "(.+)(.)" )
      if sd == "p" then K=ft.."'" end
    end
    tex.print("\coordinate ("..K..) at ("..V.re..","..V.im..) ;\\\")
  end}
}
```

It consists mainly of a loop. The variables used are K (for keys) and V (for Values). To take pairs (key/value) from the z table, use the `pairs` function. K becomes the name of a node whose coordinates are V.re and V.im. Meanwhile, we search for keys with more than one symbol ending in p, in order to associate them with the symbol "" valid in TikZ.

24.3 Complex numbers library and point

Unless you want to create your own functions, you won't need to know and use complex numbers. However, in some cases it may be useful to implement some of their properties.

`z.A = point : new (1,2)` and `z.B = point : new (1,-1)` define two affixes which are $z_A = 1 + 2i$ and $z_B = 1 - i$. Note the difference in notations `z.A` and z_A for two distinct entities: a Lua object and an affix.

If you want to use only complex numbers then you must choose the following syntax `za =point (1,2)`. The difference between `z.A = point : new (1,2)` and `za = point (1,2)` is that the first function takes into account the scale. If `scale = 2` then $z_A = 2 + 4i$. In addition, the object referenced by A is stored in table z and not za.

The notation may come as a surprise, as I used the term "point". The aim here was not to create a complete library on complex numbers, but to be able to use their main properties in relation to points. I didn't want to have two different levels, and since a unique connection can be established between the points of the plane and the complexes, I decided not to mention the complex numbers! But they are there.

Table 30: Point or complex metamethods.

Metamethods	Application	
<code>__add(z1,z2)</code>	<code>z.a + z.b</code>	affix
<code>__sub(z1,z2)</code>	<code>z.a - z.b</code>	affix
<code>__unm(z)</code>	<code>- z.a</code>	affix
<code>__mul(z1,z2)</code>	<code>z.a * z.b</code>	affix
<code>__concat(z1,z2)</code>	<code>z.a .. z.b</code>	dot product = real number ^a
<code>__pow(z1,z2)</code>	<code>z.a ^ z.b</code>	determinant = real number
<code>__div(z1,z2)</code>	<code>z.a / z.b</code>	affix
<code>__tostring(z)</code>	<code>tex.print(tostring(z))</code>	displays the affix
<code>__tonumber(z)</code>	<code>tonumber(z)</code>	affix or nil
<code>__eq(z1,z2)</code>	<code>eq(z.a,z.b)</code>	boolean

^a If O is the origin of the complex plan, then we get the dot product of the vectors \vec{Oa} and \vec{Ob}

Table 31: Point (complex) class methods.

Methods	Application	
<code>conj(z)</code>	<code>z.a : conj()</code>	affix (conjugate)
<code>mod(z)</code>	<code>z.a : mod()</code>	real number = modulus z.a
<code>abs(z)</code>	<code>z.a : abs()</code>	real number = modulus
<code>norm(z)</code>	<code>z.a : norm()</code>	norm (real number)
<code>arg(z)</code>	<code>z.a : arg()</code>	real number = argument of z.a (in rad)
<code>get(z)</code>	<code>z.a : get()</code>	re and im (two real numbers)
<code>sqrt(z)</code>	<code>z.a : sqrt()</code>	affix

The class is provided with two specific metamethods.

- Since concatenation makes little sense here, the operation associated with `..` is the scalar or dot product. If $z1 = a+ib$ and $z2 = c+id$ then $z1..z2 = (a+ib) .. (c+id) = (a+ib) (c-id) = ac+bd + i(bc-ad)$. There's also a mathematical function, `dot_product`, which takes three arguments. See example 22.12
- With the same idea, the operation associated with `^` is the determinant i.e. $z1 ^ z2 = (a+ib) ^ (c+id) = ad - bc$. From $(a-ib) (c+id) = ac+bd + i(ad - bc)$ we take the imaginary part.

24.3.1 Example of complex use

Let `za = math.cos(a) + i math.sin(a)`. This is obtained from the library by writing

```
za = point(math.cos(a),math.sin(a)).
```

Then $z.B = z.A * za$ describes a rotation of point A by an angle a .

```
\directlua{%
  init_elements ()
  z.O = point : new (0,0)
  z.A = point : new (1,2)
  a = math.pi/6
  za = point(math.cos(a),math.sin(a))
  z.B = z.A * za
}
\begin{tikzpicture}
\tkzGetNodes
\tkzDrawPoints(O,A,B)
\tkzDrawArc[->,delta=0](O,A)(B)
\tkzDrawSegments[dashed](O,A O,B)
\tkzLabelAngle(A,O,B){$\pi/6$}
\end{tikzpicture}
```

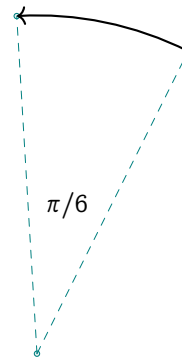

24.3.2 Point operations (complex)

```
\directlua{%
init_elements ()
  z.o = point: new(0,0)
  z.a = point: new(1,-1)
  z.b = point: new(2,1)
  z.bp = -z.b
  z.c = z.a + z.b
  z.d = z.a - z.b
  z.e = z.a * z.b
  z.f = z.a / z.b
  z.ap = point.conj (z.a)
  % = z.a : conj ()
  z.g = z.b* point(math.cos(math.pi/2),
                  math.sin(math.pi/2))
}
\begin{tikzpicture}
\tkzGetNodes
\tkzInit[xmin=-2,xmax=3,ymin=-2,ymax=3]
\tkzGrid
\tkzDrawSegments(o,a o,b o,c o,e o,b' o,f o,g)
\tkzDrawSegments[red](a,c b,c b',d a,d)
\tkzDrawPoints(a,...,g,o,a',b')
\tkzLabelPoints(o,a,b,c,d,e,f,g,a',b')
\end{tikzpicture}
```

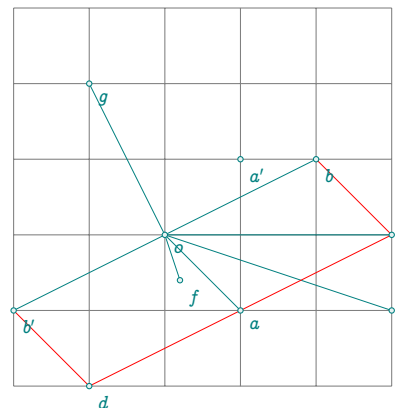

24.4 Barycenter

Here's the definition of the barycenter, which is used some forty times in the package.

`table.pack` builds a table from a list.

`tp.n` gives the number of pairs.

`tp[i][1]` is an affix and `tp[i][2]` the associated weight (real value). See the example.

```
function barycenter_ (...)
local tp = table.pack(...)
local i
local sum = 0
local weight=0
for i=1,tp.n do
    sum = sum + tp[i][1]*tp[i][2]
    weight = weight + tp[i][2]
end
return sum/weight
end
```

24.4.1 Using the barycentre

```
\directlua{%
init_elements ()
z.A = point: new (1,0)
z.B = point: new (5,-1)
z.C = point: new (2,5)
z.G = barycenter ({z.A,3},{z.B,1},{z.C,1})
}

\begin{tikzpicture}
\tkzGetNodes
\tkzDrawPolygon(A,B,C)
\tkzDrawPoints(A,B,C,G)
\end{tikzpicture}
```

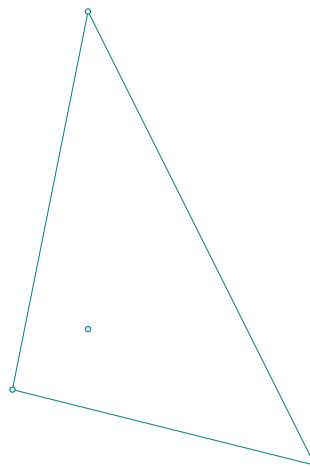

24.4.2 Incenter of a triangle

The calculation of the weights k_a , k_b and k_c is precise, and the result obtained with the barycenter is excellent. Note the presence of the underscore `_` for certain functions. These functions are internal (developer). Each external (user) function is associated with its internal counterpart.

Here's how to determine the center of the inscribed circle of a triangle:

```
function in_center_ ( a,b,c )
    local ka = point.abs (b-c)
    local kc = point.abs (b-a)
    local kb = point.abs (c-a)
    return barycenter_ ( {a,ka} , {b,kb} , {c,kc} )
```

24.5 Loop and table notation

The problem encountered in this example stems from the notation of the point names. Since it's not possible to write in simplified form, we have to resort to `table[key]` notation.

```

\directlua{%
init_elements ()
local r = 3
z.0 = point : new (0,0)
max = 100
for i = 1,max
do
z["A_"..i] = point : polar(r,2*i*math.pi/max)
end
a = math.deg(get_angle (z.0,z.A_1,z.A_2))
}

```

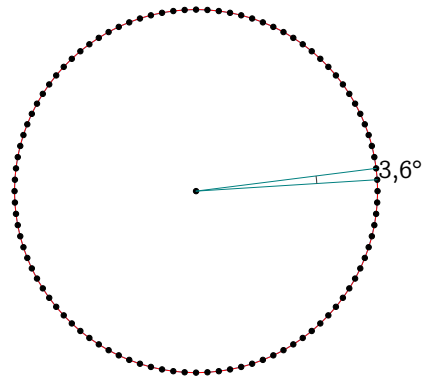

```

\begin{tikzpicture}
\pgfkeys{/pgf/number format/.cd,use comma}
\let\pmpn\pgfmathprintnumber
\tkzGetNodes
\tkzDrawPolygon[cyan](A_1,A_... ,A_\tkzUseLua{max})
\tkzDrawCircle[red](0,A_1)
\tkzDrawPoints[color=black](A_1,A_... ,A_\tkzUseLua{max},0)
\tkzDrawSegments(0,A_1 0,A_2)
\tkzMarkAngle[size=2](A_1,0,A_2)
\tkzLabelAngle[pos=3.4](A_1,0,A_2){$\pmpn{\tkzUseLua{a}}^\circ$}
\end{tikzpicture}

```

24.6 Use of tables

24.6.1 Classic parabola

This example moves away from the concept of Euclidean geometry, but the method used can be reused. Here we want to draw a parabola whose axis of symmetry is parallel to the y-axis. Knowing three of its points, we can determine the equation.

```

\directlua{
z.a = point: new (1,0)
z.b = point: new (3,2)
z.c = point: new (0,2)
local A,B,C = parabola (z.a,z.b,z.c)

function f(t0, t1, n)
local tbl = {}
for t = t0,t1,(t1-t0)/n do
y = A*t^2+B*t +C
table.insert (tbl, ("..t..","..y.."))
end
return tbl
end
}
\begin{tikzpicture}
\tkzGetNodes
\tkzInit[xmin = -2,xmax=4,ymin = -1,ymax=6]
\tkzDrawX\tkzDrawY
\tkzDrawPoints[red,size=4pt](a,b,c)
\draw[smooth] plot coordinates {%
\directlua{tex.print(f(-1,3,100))}};
\end{tikzpicture}

```

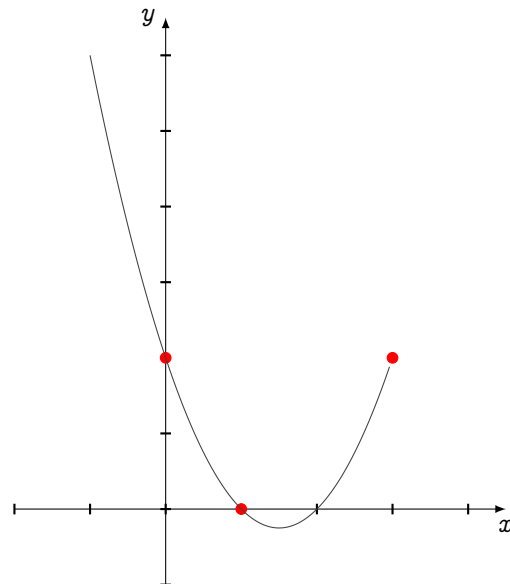

24.6.2 Plotting a curve

In this example, we'll use lua to plot the representative curve of the function

$$y = f(x) = x * \exp(-x^2) + 1$$

We'll use a table called "points" to store the coordinates of the points on the curve.

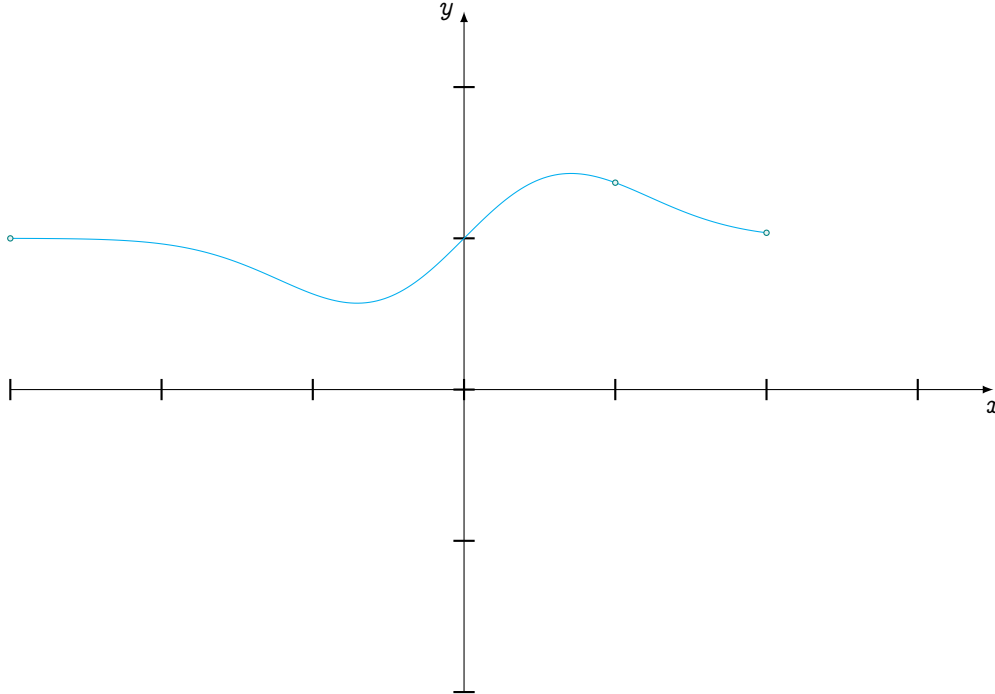

```

\makeatletter\let\percentchar\@percentchar\makeatother
\directlua{

\def\tkzval#1{%
\directlua{%
  local expr = [[\tkzfct]]
  local f = load (("
    return function (x)
      return (\percentchar s)
    end"):format (expr), nil, 't', math) ()
tex.print(f(#1)) % Calcule la valeur pour l'entrée donnée
}}
\def\tkzcalcval(#1,#2,#3,#4,#5){%
\directlua{
local min, max, nb = #2, #3, #4 % Bornes et divisions
local expr = [[#1]]
#5 = {}
local f = load ("return function (x) return (\percentchar s) end")
:format (expr), nil, 't', math) ()
for t = min,max,(max-min)/nb do
local x = checknumber(t)
local y = checknumber(f(t))
if (y==math.huge or y==math.huge) then tex.print("problem") end
table.insert (#5, "..x..", "..y..")
end}}
\def\tkzfct{x*exp(-x^2)+1}

```

```
\begin{tikzpicture}
  \tkzInit[xmin=-3,xmax=3,ymin=-2,ymax=2]
  \tkzDrawX\tkzDrawY
  \tkzcalcval(\tkzfct,-3,2,100,curve)
  \tkzDrawCoordinates[smooth,cyan](curve)
  \tkzDrawPoint(-3,\tkzval{-3})
  \tkzDrawPoint(1,\tkzval{1})
  \tkzDrawPoint(2,\tkzval{2})
\end{tikzpicture}
```

24.7 In_out method

This function can be used for the following objects

- line
- circle
- triangle
- conic (parabola, hyperbola, ellipse)

The disk object doesn't exist, so with `in_out_disk` it's possible to determine whether a point is in a disk.

24.7.1 In_out for a line

```
function line: in_out (pt)
  local sc,epsilon
  epsilon = 10^(-12)
  sc = math.abs ((pt-self.pa)^(pt-self.pb))
  if sc <= epsilon
    then
      return true
    else
      return false
    end
  end
end
```

The `ifthen` package is required for the code below.

```

\directlua{%
init_elements ()
z.A = point: new (0,0)
z.B = point: new (1,2)
z.X = point: new (2,4.000)
z.Y = point: new (2,4.1)
L.AB = line : new (z.A,z.B)
if L.AB : in_out (z.X)
then
inline = true k = (z.X-z.A)/(z.B-z.A)
else
inline = false
end
inline_bis = L.AB : in_out (z.Y)
}

\begin{tikzpicture}
\tkzGetNodes
\tkzDrawPoints(A,B,X,Y)
\tkzLabelPoints(A,B,X)
\tkzLabelPoints[left](Y)
\ifthenelse{\equal{\tkzUseLua{inline}}{true}}{
\tkzDrawSegment[red](A,B)
\tkzLabelSegment(A,B){AX/AB = $\tkzUseLua{k}$}{%
\tkzDrawSegment[blue](A,B)}
\ifthenelse{\equal{\tkzUseLua{inline_bis}}{false}}{%
\tkzDrawSegment[green](B,Y)}{}}
\end{tikzpicture}

```

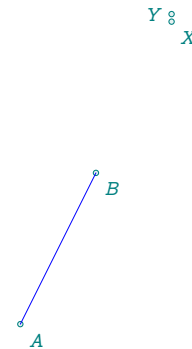

24.8 Determinant and dot product

24.8.1 Determinant

We've just seen how to use \wedge to obtain the determinant associated with two vectors. `in_out` is simply a copy of `islinear`. Here's the definition and transformation of the power of a complex number.

```

% determinant is '^' ad - bc
function point.__pow(z1,z2)
local z
z = point.conj(z1) * z2 % (a-ib) (c+id) = ac+bd + i(ad - bc)
return z.im
end

```

24.8.2 Dot product

Here's the definition of the dot product between two affixes and the concatenation transformation.

```

% dot product is '..' result ac + bd
function point.__concat(z1,z2)
local z
z = z1 * point.conj(z2) % (a+ib) (c-id) = ac+bd + i(bc-ad)
return z.re
end

```

24.8.3 Dot product: orthogonality test

Here's a function `isortho` to test orthogonality between two vectors.

```

function isortho (z1,z2,z3)
  local epsilon
  local dp
  epsilon = 10^(-8)
  dp = (z2-z1) .. (z3-z1)
  if math.abs(dp) < epsilon
    then
      return true
    else
      return false
    end
  end
end

```

24.8.4 Dot product: projection

The projection of a point onto a straight line is a fundamental function, and its definition is as follows:

```

function projection_ ( pa,pb,pt )
  local v
  local z
  if aligned ( pa,pb,pt ) then
    return pt
  else
    v = pb - pa
    z = ((pt - pa)..v)/(point.norm(v)) -- .. dot product
    return pa + z * v
  end
end

```

The function `aligned` is equivalent to `islinear` but does not use a determinant. It will be replaced in a future version.

24.9 Point method

The point method is a method for many objects:

- line ,
- circle,
- conic (parabola, hyperbola, ellipse),
- triangle.

You obtain a point on the object by entering a real number between 0 and 1.

```

\directlua{%
init_elements ()
  z.A = point : new ( 0 , 0 )
  z.B = point : new ( 4 , 2 )
  z.C = point : new ( 1 , 3 )
  L.AB = line : new (z.A,z.B)
  C.AB = circle : new (z.A,z.B)
  T.ABC = triangle : new (z.A,z.B,z.C)
  z.I = L.AB : point (0.5)
  z.J = C.AB : point (0.5)
  z.K = T.ABC : point (0.5)
}
\begin{tikzpicture}
  \tkzGetNodes
  \tkzDrawLine(A,B)
  \tkzDrawCircle(A,B)
  \tkzDrawPolygon(A,B,C)
  \tkzDrawPoints(A,B,C,I,J,K)
\end{tikzpicture}

```

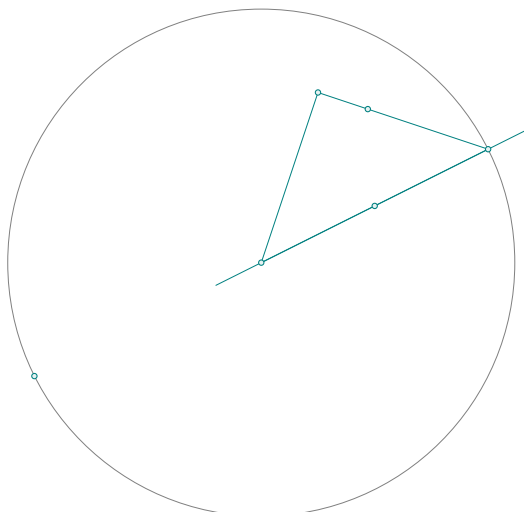

24.10 Behind the objects

Before introducing objects, I only used functions whose parameters were points (complexes).

For example, $z.m = \text{midpoint}_-(z.a, z.b)$ defines the midpoint of points a and b . With objects, first define the line/segment $L.ab$ and then obtain the middle with $z.m = L.ab.mid$.

I've kept the functions (which I'll call "primary") whose only arguments are points. They are distinguished from the others by a terminal underscore. In fact, all (almost) object-related functions depend on a primary function. We've just seen the case of the midpoint of a point, so let's look at two other cases:

- Rotation around a point. c is the center of rotation, a the angle and pt the point to be affected. For example:
 $z.Mp = \text{rotation} (z.A, \text{math.pi}/6, z.M)$

```

function rotation_ (c,a,pt)
local z = point( math.cos(a) , math.sin(a) )
return z*(pt-c)+c
end

```

With objects, this gives $z.Mp = z.A : \text{rotation} (\text{math.pi}/6, z.M)$

- The intersection of a line and a circle is obtained using $\text{intersection_lc}_-(z.A, z.B, z.O, z.T)$. using the straight line (A, B) and the circle $C(O, T)$.

This will result in the objects: $\text{intersection} (L.AB, C.OT)$

The difference is that programming is more direct with primary functions and a little more efficient, but loses visibility.

25 Some theorems

25.1 Viviani's Theorem

Viviani's theorem, named after Vincenzo Viviani, states that the sum of the shortest distances from any interior point to the sides of an equilateral triangle equals the length of the triangle's altitude. [Wikipedia]. Here's the visual demonstration I gave at the CAPES oral exam in 1989 to become a teacher.

```

\directlua{
z.A      = point: new (0 , 0)
z.B      = point: new (8 , 0)
L.AB     = line: new (z.A,z.B)
T.equ    = L.AB:equilateral ()
z.C      = T.equ.pc
z.I      = point:new (3,2)
L.IAB    = T.equ.ab:ll_from(z.I)
L.IBC    = T.equ.bc:ll_from(z.I)
L.ICA    = T.equ.ca:ll_from(z.I)
z.b      = intersection(L.IAB,T.equ.ca)
z.a      = intersection(L.IAB,T.equ.bc)
z.c      = intersection(L.IBC,T.equ.ab)
z.d      = intersection(L.IBC,T.equ.ca)
z.e      = intersection(L.ICA,T.equ.ab)
z.f      = intersection(L.ICA,T.equ.bc)
L.last   = T.equ.ab:ll_from(z.f)
z.g      = intersection(L.last,T.equ.ca)
z.pC     = L.last:projection(z.C)
z.pIca   = T.equ.ca:projection(z.I)
z.pIbc   = T.equ.bc:projection(z.I)
z.pIAB   = L.IAB:projection(z.f)
z.pIab   = T.equ.ab:projection(z.I)
}
\begin{tikzpicture}
\tkzGetNodes
\tkzDrawPolygons(A,B,C)
\tkzDrawSegments(a,b c,d e,f f,g)
\tkzDrawSegments[red,thick](C,pC I,pIab f,pIAB)
\tkzDrawSegments[red,dashed](I,pIbc I,pIca)
\end{tikzpicture}

```

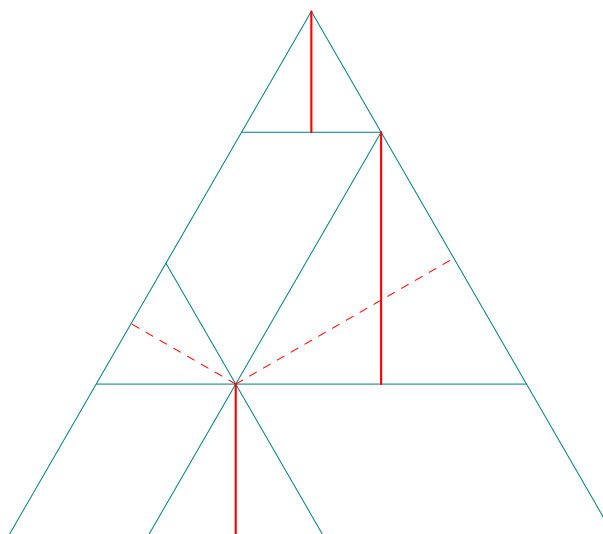

25.2 Reuschle's theorem

In elementary geometry, Reuschle's theorem describes a property of the cevians of a triangle intersecting in a common point and is named after the German mathematician Karl Gustav Reuschle (1812–1875). It is also known as Terquem's theorem after the French mathematician Olry Terquem (1782–1862), who published it in 1842.

```

\directlua{
init_elements ()
z.A   = point:new(0, 0)
z.B   = point:new(8, 0)
z.C   = point:new(5, 5)
z.P   = point:new(4, 2)
T.ABC = triangle:new(z.A,z.B,z.C)
T.cev = T.ABC:cevia (z.P)
z.D,
z.E,
z.F   = get_points(T.cev)
C.cev = T.ABC :cevia_circle (z.P)
z.O   = C.cev.center
z.T   = C.cev.through
z.G   = intersection(C.cev,T.ABC.ca)
_,z.H = intersection(C.cev,T.ABC.ab)
z.I   = intersection(C.cev,T.ABC.bc)
L.AI  = line:new(z.A,z.I)
L.BG  = line:new(z.B,z.G)
z.K   = intersection(L.AI,L.BG)
}
\begin{tikzpicture}
\tkzGetNodes
\tkzDrawPolygons(A,B,C)
\tkzDrawPoints(A,...,I,P,K)
\tkzDrawSegments(A,D B,E C,F A,I B,G C,H)
\tkzDrawCircle(O,T)
\tkzLabelPoints[below](A,B)
\tkzLabelPoints[above](C,I,E,D,G,K)
\tkzLabelPoints[below](F,P,H)
\end{tikzpicture}

```

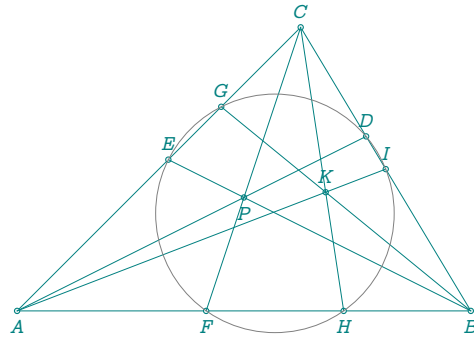

25.3 Thébault's problem III

Given any triangle ABC , and any point M on BC , construct the incircle and circumcircle of the triangle. Then construct two additional circles, each tangent to AM , BC , and to the circumcircle. Then their centers and the center of the incircle are collinear.[wikipedia]

```

\directlua{
init_elements()
z.A = point : new(0, 0)
z.B = point : new(8, 0)
z.C = point : new(1, 6)
z.M = point : new(5, 0)
L.CM = line:new(z.C,z.M)
T.ABC = triangle:new(z.A,z.B,z.C)
C.circ = T.ABC:circum_circle()
z.O = C.circ.center
C.ins = T.ABC:in_circle()
z.I = C.ins.center
z.T = C.ins.through
L.ll = T.ABC.ab: ll_from(z.I)
z.Q = intersection(L.ll,L.CM)
C.QI = circle:new(z.Q,z.I)
z.R,z.S= intersection(C.QI,L.CM)
L.BMC = bisector(z.M,z.B,z.C)
z.x = L.BMC.pb
L.CMA = bisector(z.M,z.C,z.A)
z.y = L.CMA.pb
L.pS = L.CM:ortho_from(z.S)
L.pR = L.CM:ortho_from(z.R)
z.J = intersection(L.pS,L.CMA)
z.K = intersection(L.pR,L.BMC)
}
\begin{tikzpicture}[scale = .75]
\tkzGetNodes
\tkzDrawPolygon(A,B,C)
\tkzDrawSegments(C,M)
\tkzDrawLines(J,K I,Q)
\tkzDrawCircles(O,A I,T Q,I J,S K,R)
\tkzDrawPoints(A,B,C,M,Q,I,R,S,J,K)
\tkzLabelPoints(A,B,C,M,Q,I,R,S,J,K)
\end{tikzpicture}

```

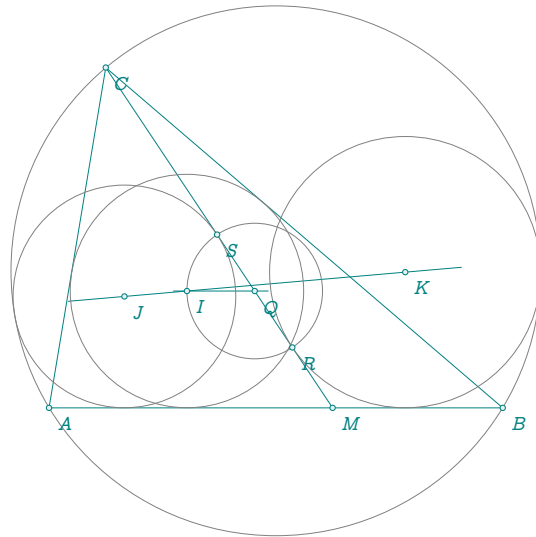

25.4 Thebault's problem II

Given a square, construct equilateral triangles on two adjacent edges, either both inside or both outside the square. Then the triangle formed by joining the vertex of the square distant from both triangles and the vertices of the triangles distant from the square is equilateral. [wikipedia]

```

\directlua{
init_elements()
z.A = point : new ( 0 , 0 )
z.B = point : new ( 8 , 0 )
L.AB = line:new (z.A,z.B)
S.ABCD = L.AB:square()
z.C = S.ABCD.pc
z.D = S.ABCD.pd
z.E = S.ABCD.ab:equilateral().pc
z.F = S.ABCD.bc:equilateral().pc
}
\begin{tikzpicture}[scale = .75]
\tkzGetNodes
\tkzDrawPolygon(A,B,C,D)
\tkzDrawPolygons[cyan](A,B,E B,C,F)
\tkzFillPolygon[fill=orange!20](D,E,F)
\tkzDrawPolygons[orange,thick](D,E,F)
\end{tikzpicture}

```

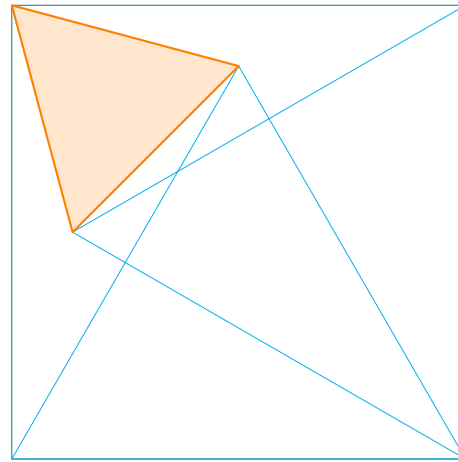

25.5 Varignon's Theorem

In Euclidean geometry, Varignon's theorem holds that the midpoints of the sides of an arbitrary quadrilateral form a parallelogram, called the Varignon parallelogram. It is named after Pierre Varignon, whose proof was published posthumously in 1731. [Wikipedia]

```

\directlua{
init_elements()
z.A = point : new ( 0 , 0 )
z.B = point : new ( 0 , 8 )
z.C = point : new ( 5 , 3 )
z.D = point : new ( -1 , 6 )
Q.ABCD = quadrilateral:new(z.A, z.B, z.C, z.D)
z.E,z.F,z.G,z.H = midpoints(z.A,z.B,z.C,z.D)
}
\begin{tikzpicture}[scale = .75]
\tkzGetNodes
\tkzDrawPolygon(A,B,C,D)
\tkzDrawPolygon[red](E,F,G,H)
\tkzDrawPoints(A,B,C,D)
\tkzDrawPoints[red](E,F,G,H)
\tkzLabelPoints(A,C)
\tkzLabelPoints[above right](B,D)
\tkzLabelPoints[red](G,H)
\tkzLabelPoints[red,above right](E,F)
\end{tikzpicture}

```

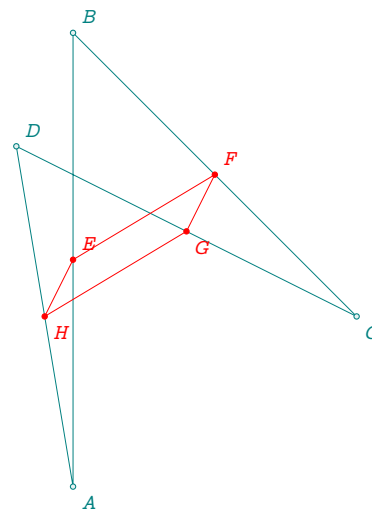

25.6 Wittenbauer's Parallelogram

Divide the sides of a quadrilateral into three equal parts. The figure formed by connecting and extending adjacent points on either side of a polygon vertex is a parallelogram known as Wittenbauer's parallelogram. [Weisstein, Eric W. "Wittenbauer's Parallelogram." From MathWorld—A Wolfram Web Resource.]

```

\directlua{
init_elements()
z.A = point : new ( 0 , 0 )
z.B = point : new ( 4 , 0 )
z.C = point : new ( 5 , 3 )
z.D = point : new ( -1 , 4 )
Q.ABCD = quadrilateral:new (z.A, z.B, z.C, z.D)
z.P_1 = Q.ABCD.ab:point(1/3)
z.P_2 = Q.ABCD.ab:point(2/3)
z.P_3 = Q.ABCD.bc:point(1/3)
z.P_4 = Q.ABCD.bc:point(2/3)
z.P_5 = Q.ABCD.cd:point(1/3)
z.P_6 = Q.ABCD.cd:point(2/3)
z.P_7 = Q.ABCD.da:point(1/3)
z.P_8 = Q.ABCD.da:point(2/3)
L.P18 = line:new(z.P_1,z.P_8)
L.P23 = line:new(z.P_2,z.P_3)
L.P45 = line:new(z.P_4,z.P_5)
L.P67 = line:new(z.P_6,z.P_7)
z.K = intersection(L.P18,L.P23)
z.L = intersection(L.P23,L.P45)
z.M = intersection(L.P45,L.P67)
z.N = intersection(L.P67,L.P18)
}
\begin{tikzpicture}[scale = .75]
\tkzGetNodes
\tkzDrawPolygon(A,B,C,D)
\tkzDrawPolygon[red](K,L,M,N)
\tkzDrawSegments(A,C B,D)
\tkzDrawPoints(A,B,C,D)
\end{tikzpicture}

```

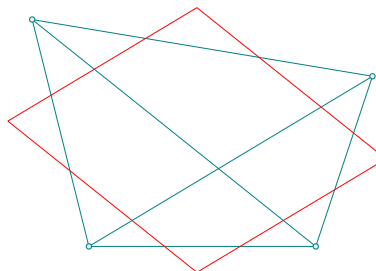

25.7 Soddy circles of a triangle

In geometry, the Soddy circles of a triangle are two circles associated with any triangle in the plane.[wikipedia] Given three noncollinear points, construct three tangent circles such that one is centered at each point and the circles are pairwise tangent to one another. Then there exist exactly two nonintersecting circles that are tangent to all three circles. These are called the inner and outer Soddy circles, and their centers are called the inner and outer Soddy centers, respectively.

[Weisstein, Eric W. "Soddy Circles." From MathWorld—A Wolfram Web Resource]

25.7.1 Soddy circle without function

```

\directlua{%
init_elements ()
z.A = point : new ( 0 , 0 )
z.B = point : new ( 5 , 0 )
z.C = point : new ( 0.5 , 4 )
T.ABC = triangle : new ( z.A,z.B,z.C )
z.I = T.ABC.incenter
z.E,z.F,z.G = T.ABC : projection (z.I)
C.ins = circle : new (z.I,z.E)
T.orthic = T.ABC : orthic ()
z.Ha,z.Hb,z.Hc = get_points (T.orthic)
C.CF = circle : new ( z.C , z.F )
C.AG = circle : new ( z.A , z.G )
}

```

```

C.BE = circle : new ( z.B , z.E )
L.Ah = line : new ( z.A , z.Ha )
L.Bh = line : new ( z.B , z.Hb )
L.Ch = line : new ( z.C , z.Hc )
z.X,z.Xp = intersection (L.Ah,C.AG)
z.Y,z.Yp = intersection (L.Bh,C.BE)
z.Z,z.Zp = intersection (L.Ch,C.CF)
L.XpE = line : new (z.Xp,z.E)
L.YpF = line : new (z.Yp,z.F)
L.ZpG = line : new (z.Zp,z.G)
z.S = intersection (L.XpE,L.YpF)
z.Xi = intersection(L.XpE,C.AG)
z.Yi = intersection(L.YpF,C.BE)
_,z.Zi = intersection(L.ZpG,C.CF)
z.S = triangle : new (z.Xi,z.Yi,z.Zi).circumcenter
C.soddy_int = circle : new (z.S,z.Xi)
C.soddy_ext = C.ins : inversion (C.soddy_int)
z.w = C.soddy_ext.center
z.s = C.soddy_ext.through
z.Xip,z.Yip,z.Zip = C.ins : inversion (z.Xi,z.Yi,z.Zi)
}

\begin{tikzpicture}
\tkzGetNodes
\tkzDrawPolygon(A,B,C)
\tkzDrawPoints(A,B,C,E,F,G,Ha,Hb,Hc,X,Y,Z,X',Y',Z',Xi,Yi,Zi,I)
\tkzDrawPoints(Xi',Yi',Zi',S)
\tkzLabelPoints(A,B,C,E,F,G,X,Y,Z,X',Y',Z')
\tkzDrawCircles(A,G B,E C,F I,E S,Xi w,s)
\tkzDrawLines(X',Ha Y',Hb Z',Hc)
\tkzDrawLines(X',E Y',F Z',G)
\end{tikzpicture}

```

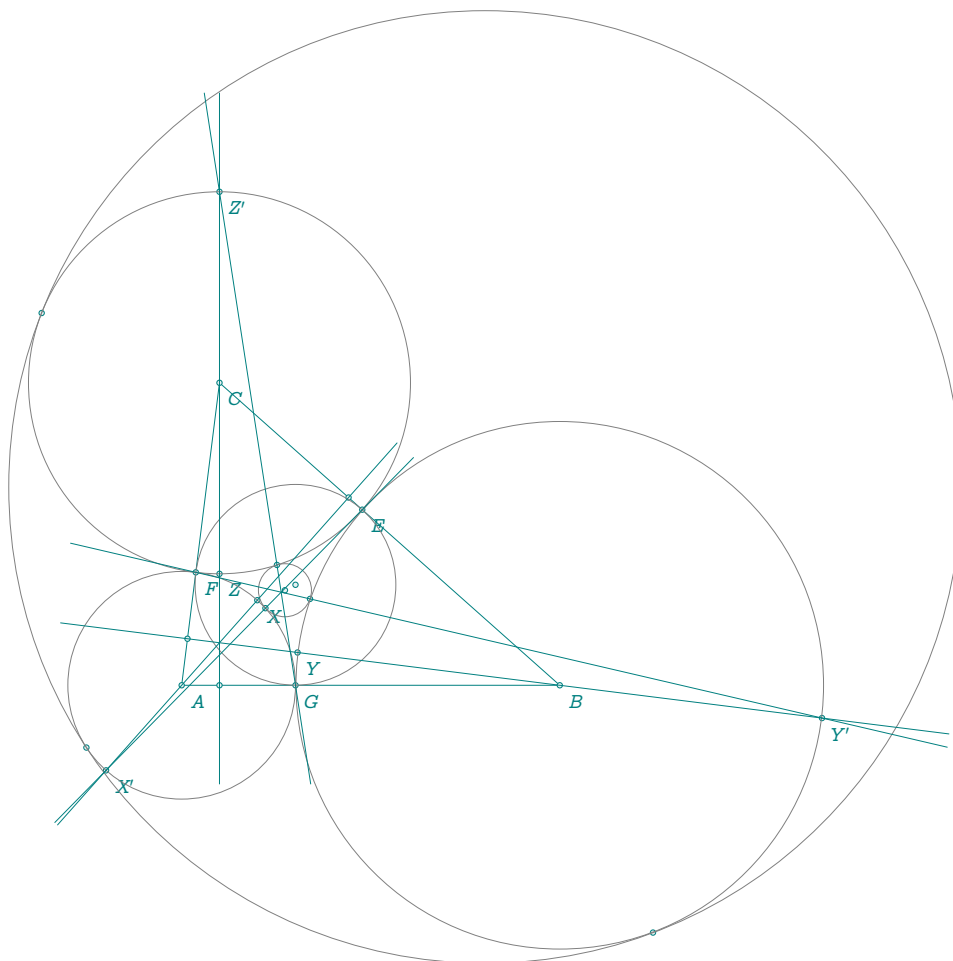

25.7.2 Soddy circle with function

```

\directlua{%
  init_elements ()
  z.A = point : new ( 0 , 0 )
  z.B = point : new ( 5 , 0 )
  z.C = point : new ( 4 , 4 )
  T.ABC = triangle : new ( z.A,z.B,z.C )
  z.I = T.ABC.incenter
  z.E,z.F,z.G = T.ABC : projection (z.I)
  T.orthic = T.ABC : orthic ()
  z.Ha,z.Hb,z.Hc = get_points (T.orthic)
  C.ins = circle : new (z.I,z.E)
  z.s,z.xi,z.yi,
  z.zi = T.ABC : soddy_center ()
  C.soddy_int = circle : new (z.s,z.xi)
  C.soddy_ext = C.ins : inversion (C.soddy_int)
  z.w = C.soddy_ext.center
  z.t = C.soddy_ext.through
  z.Xip,z.Yip,
  z.Zip = C.ins : inversion (z.xi,z.yi,z.zi)
}

\begin{tikzpicture}
\tkzGetNodes
\tkzDrawPolygon(A,B,C)

```

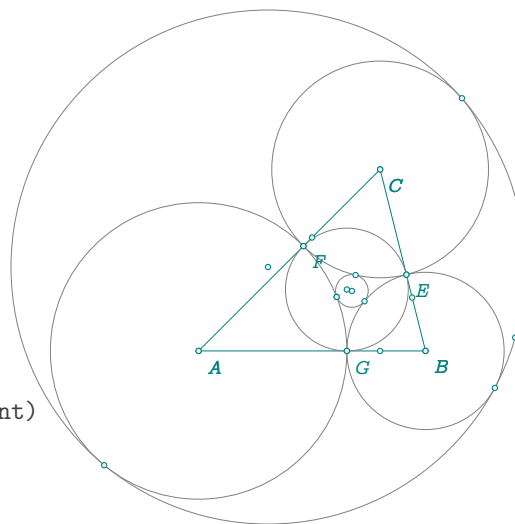

```

\tkzDrawCircles(A,G B,E C,F I,E s,xi w,t)
\tkzDrawPoints(A,B,C,E,F,G,s,w,xi,t)
\tkzLabelPoints(A,B,C)
\tkzDrawPoints(A,B,C,E,F,G,Ha,Hb,Hc,xi,yi,zi,I)
\tkzDrawPoints(Xi',Yi',Zi')
\tkzLabelPoints(A,B,C,E,F,G)
\end{tikzpicture}

```

25.8 Six circles in a triangle

In geometry, the six circles theorem relates to a chain of six circles together with a triangle, such that each circle is tangent to two sides of the triangle and also to the preceding circle in the chain. The chain closes, in the sense that the sixth circle is always tangent to the first circle.[1][2] It is assumed in this construction that all circles lie within the triangle, and all points of tangency lie on the sides of the triangle. [Wikipedia]

The file `search_circle.lua` used in this example:

```

local r = ...

function newcircle (T,C)
  local NT,L,NC,c,t
  NT = T.incenter : homothety ((1+C.radius/T.inradius),T)
  L = line : new (NT.pb,NT.pa)
  _,NC = L : c_ll_p(NT.pc,C.center)
  return NC.center,T.bc:projection(NC.center)
end

z.A = point : new ( 0 , 0 )
z.B = point : new ( 8 , 0 )
z.C = point : new ( 2 , 6 )
T.ABC = triangle : new (z.A,z.B,z.C)
L.ba = T.ABC : bisector ()
z.c1 = L.ba : report(r)
z.t1 = T.ABC.ab : projection(z.c1)
C.last = circle : new(z.c1,z.t1)

local vertices = {"A", "B", "C"}
for i = 2, 6 do
  T.used = triangle : new(
    z[vertices[math.fmod(i - 2, 3) + 1]],
    z[vertices[math.fmod(i - 1, 3) + 1]],
    z[vertices[math.fmod(i, 3) + 1]] )
  z["c" .. i], z["t" .. i] = newcircle(T.used, C.last)
  C.last = circle : new(z["c" .. i], z["t" .. i])
end

```

```

\directlua{
init_elements ()
z.A   = point : new ( 0 , 0 )
z.B   = point : new ( 8 , 0 )
z.C   = point : new ( 2 , 6 )
loadfile ("search_circle.lua")(1.4)
}
\begin{tikzpicture}
\tkzGetNodes
\tkzFillPolygon[lightgray!30](A,B,C)
\foreach \n/\c in {1/red,2/orange,%
3/yellow,4/green,5/blue,6/violet}
{\tkzFillCircle[\c!30,opacity=.4](c\n,t\n)
\tkzDrawCircle[thick,\c](c\n,t\n)}
\tkzDrawPolygon[thick](A,B,C)
\tkzDrawPoints(A,B,C)
\end{tikzpicture}

```

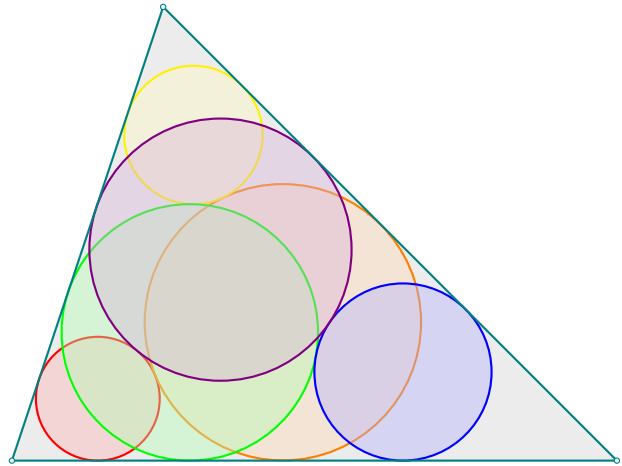

When the first circle is the incircle then you get only 4 circles.

```

T.ABC = triangle : new (z.A,z.B,z.C)
R = T.ABC.inradius/math.sin((T.ABC.alpha)/2)
loadfile ("search_circle.lua")(R)
}

```

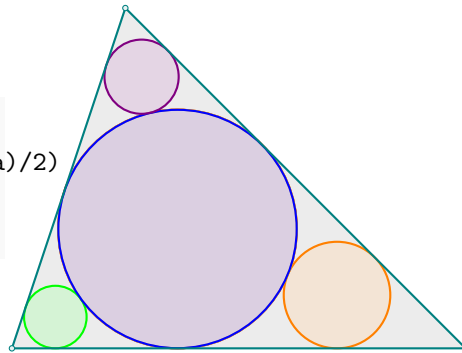

26 Examples

26.1 Length transfer

Use of north and east functions linked to points, to transfer lengths, Refer to (22.1)

```
\directlua{%
init_elements ()
  z.A = point : new ( 0 , 0 )
  z.B = point : new ( 3 , 0 )
  L.AB = line : new ( z.A , z.B )
  T.ABC = L.AB : sublime ()
  z.C = T.ABC.pc
  z.D = z.B: north (length(z.B,z.C))
  z.E = z.B: east (L.AB.length)
  z.M = L.AB.mid
  z.F = z.E : north (length(z.C,z.M))
}
\begin{tikzpicture}[gridded,scale=.75]
  \tkzGetNodes
  \tkzDrawPolygons(A,B,C)
  \tkzDrawSegments[gray,dashed](B,D B,E E,F C,M)
  \tkzDrawPoints(A,...,F)
  \tkzLabelPoints(A,B,E,M)
  \tkzLabelPoints[above right](C,D,F)
\end{tikzpicture}
```

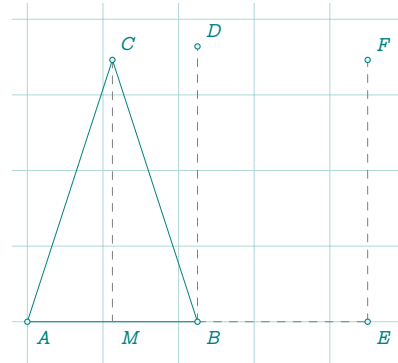

26.2 Apollonius circles of a triangle

The three Apollonius circles of a (non-equilateral) triangle meet at exactly two points.

Proof:

Let ABC be a non-equilateral triangle, say with $AB \neq AC$. By definition, we have directly that if a point belongs to two of the circles, then it belongs to the third. Indeed, if

$$\frac{MB}{MC} = \frac{AB}{AC} \text{ and } \frac{MA}{MB} = \frac{CA}{CB} \text{ then } \frac{MA}{MC} = \frac{BA}{BC}$$

However, the circles are neither tangent nor disjoint if $AB \neq AC$.

The three Apollonius circles are coaxial.

```
\directlua{%
z.A = point : new (0,0)
z.B = point : new (5,0)
z.C = point : new (3.5,2)
T = triangle : new (z.A,z.B,z.C)
z.O = T.circumcenter
C.AB = T.ab : apollonius(T.b/T.a)
z.w1,z.t1 = get_points(C.AB)
C.BC = T.bc : apollonius(T.c/T.b)
z.w2,z.t2 = get_points(C.BC)
C.AC = T.ca : apollonius(T.a/T.c)
z.w3,z.t3 = get_points(C.AC)
}
\begin{tikzpicture}[scale=.5]
  \tkzGetNodes
  \tkzDrawPolygon(A,B,C)
  \tkzDrawCircle[purple](O,A)
  \tkzDrawCircles[cyan](w1,t1 w2,t2 w3,t3)
  \tkzDrawLine(w1,w2)
```

```

\tkzDrawPoints(A,B,C,w1,w2,w3)
\tkzLabelPoints(A,B,w1,w2,w3)
\tkzLabelPoints[above](C)
\end{tikzpicture}

```

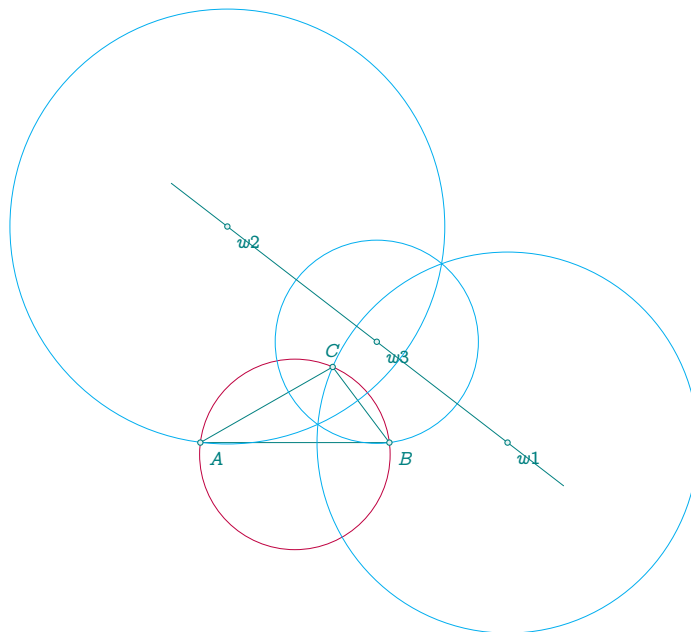

26.3 D'Alembert 1

```

\directlua{%
init_elements ()
z.A = point : new (0,0)
z.a = point : new (4,0)
z.B = point : new (7,-1)
z.b = point : new (5.5,-1)
z.C = point : new (5,-4)
z.c = point : new (4.25,-4)
C.Aa = circle : new (z.A,z.a)
C.Bb = circle : new (z.B,z.b)
C.Cc = circle : new (z.C,z.c)
z.I = C.Aa : external_similitude (C.Bb)
z.J = C.Aa : external_similitude (C.Cc)
z.K = C.Cc : external_similitude (C.Bb)
z.Ip = C.Aa : internal_similitude (C.Bb)
z.Jp = C.Aa : internal_similitude (C.Cc)
z.Kp = C.Cc : internal_similitude (C.Bb)
}
\begin{tikzpicture}[rotate=-60]
\tkzGetNodes
\tkzDrawCircles(A,a B,b C,c)
\tkzDrawPoints(A,B,C,I,J,K,I',J',K')
\tkzDrawSegments[new](I,K A,I A,J B,I B,K C,J C,K)
\tkzDrawSegments[purple](I,J' I',J I',K)
\tkzLabelPoints(I,J,K,I',J',K')
\end{tikzpicture}

```

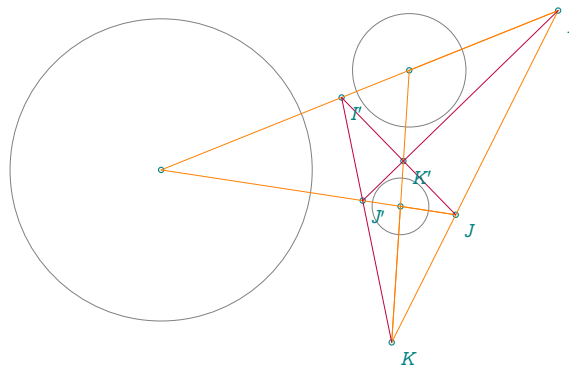

26.4 D'Alembert 2

```

\directlua{%
  init_elements ()
  z.A      = point : new (0,0)
  z.a      = point : new (5,0)
  z.B      = point : new (7,-1)
  z.b      = point : new (3,-1)
  z.C      = point : new (5,-4)
  z.c      = point : new (2,-4)
  C.Aa     = circle :   new (z.A,z.a)
  C.Bb     = circle :   new (z.B,z.b)
  C.Cc     = circle :   new (z.C,z.c)
  z.i,z.j  = get_points (C.Aa : radical_axis (C.Bb))
  z.k,z.l  = get_points (C.Aa : radical_axis (C.Cc))
  z.m,z.n  = get_points (C.Bb : radical_axis (C.Cc))
}
\begin{tikzpicture}[scale = .5]
  \tkzGetNodes
  \tkzDrawCircles(A,a B,b C,c)
  \tkzDrawLines[new](i,j k,l m,n)
\end{tikzpicture}

```

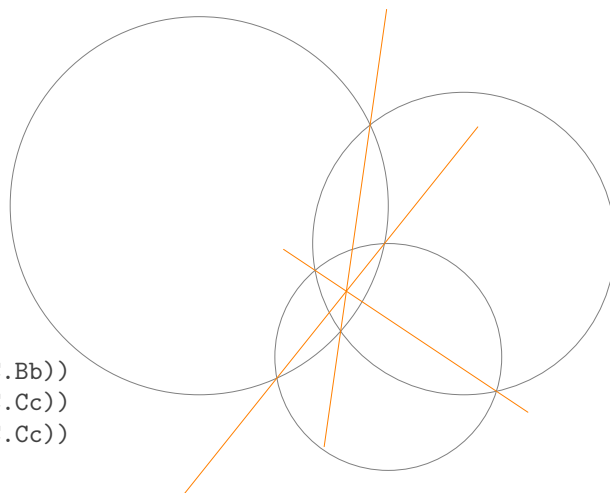

26.5 Altshiller

```

\directlua{%
  init_elements ()
  z.P      = point : new (0,0)
  z.Q      = point : new (5,0)
  z.I      = point : new (3,2)
  C.QI     = circle :   new (z.Q,z.I)
  C.PE     = C.QI : orthogonal_from (z.P)
  z.E      = C.PE.through
  C.QE     = circle :   new (z.Q,z.E)
  _,z.F    = intersection (C.PE,C.QE)
  z.A      = C.PE: point (1/9)
  L.AE     = line : new (z.A,z.E)
  _,z.C    = intersection (L.AE,C.QE)
  L.AF     = line : new (z.A,z.F)
  L.CQ     = line : new (z.C,z.Q)
  z.D      = intersection (L.AF,L.CQ)
}
\begin{tikzpicture}
  \tkzGetNodes
  \tkzDrawCircles(P,E Q,E)
  \tkzDrawLines[add=0 and 1](P,Q)
  \tkzDrawLines[add=0 and 2](A,E)
  \tkzDrawSegments(P,E E,F F,C A,F C,D)
  \tkzDrawPoints(P,Q,E,F,A,C,D)
  \tkzLabelPoints(P,Q,E,F,A,C,D)
\end{tikzpicture}

```

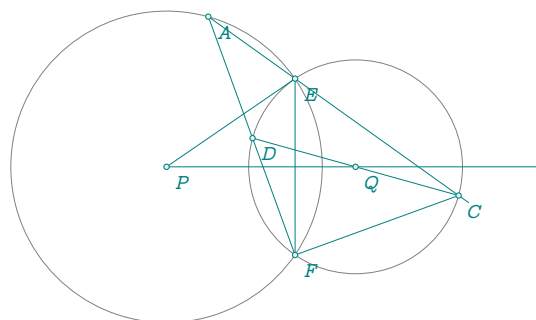

26.6 Lemoine

```

\directlua{%
  init_elements ()
  z.A = point: new (1,0)
  z.B = point: new (5,2)
  z.C = point: new (1.2,2)
  T = triangle: new(z.A,z.B,z.C)
  z.O = T.circumcenter
  C.OA = circle: new (z.O,z.A)
  L.tA = C.OA: tangent_at (z.A)
  L.tB = C.OA: tangent_at (z.B)
  L.tC = C.OA: tangent_at (z.C)
  z.P = intersection (L.tA,T.bc)
  z.Q = intersection (L.tB,T.ca)
  z.R = intersection (L.tC,T.ab)
}
\begin{tikzpicture}[scale = 1.25]
  \tkzGetNodes
  \tkzDrawPolygon[teal](A,B,C)
  \tkzDrawCircle(O,A)
  \tkzDrawPoints(A,B,C,P,Q,R)
  \tkzLabelPoints(A,B,C,P,Q,R)
  \tkzDrawLine[blue](Q,R)
  \tkzDrawLines[red](A,P B,Q R,C)
  \tkzDrawSegments(A,R C,P C,Q)
\end{tikzpicture}

```

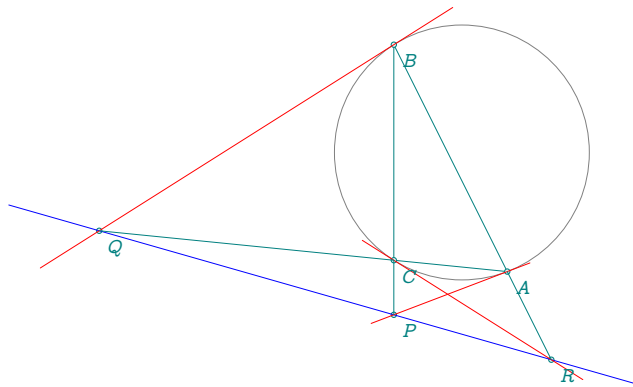

26.7 Alternate

```

\directlua{%
  init_elements ()
  z.A = point: new (0 , 0)
  z.B = point: new (6 , 0)
  z.C = point: new (1 , 5)
  T = triangle: new (z.A,z.B,z.C)
  z.I = T.incenter
  L.AI = line: new (z.A,z.I)
  z.D = intersection (L.AI,T.bc)
  L.LLC= T.ab: ll_from (z.C)
  z.E = intersection (L.AI,L.LLC)
}
\begin{tikzpicture}
  \tkzGetNodes
  \tkzDrawPolygon(A,B,C)
  \tkzDrawLine[purple](C,E)
  \tkzDrawSegment[purple](A,E)
  \tkzFillAngles[purple!30,opacity=.4](B,A,C C,E,D)
  \tkzMarkAngles[mark=|](B,A,D D,A,C C,E,D)
  \tkzDrawPoints(A,...,E)
  \tkzLabelPoints(A,B)
  \tkzLabelPoints[above](C,D,E)
  \tkzMarkSegments(A,C C,E)
\end{tikzpicture}

```

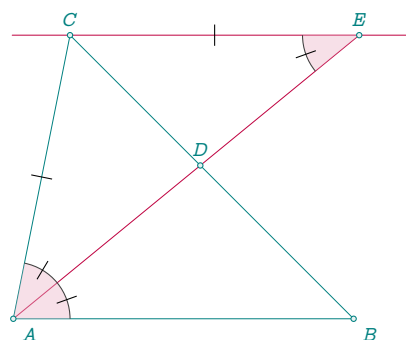

26.8 Method common tangent: orthogonality

For two circles to be orthogonal, it is necessary and sufficient for a secant passing through one of their common points to be seen from the other common point at a right angle.

```
\directlua{%
  init_elements ()
  z.A = point : new ( 0 , 0 )
  z.B = point : new ( 4 , 2 )
  L.AB = line : new ( z.A , z.B )
  z.a = point : new ( 1 , 2 )
  C.Aa = circle : new ( z.A,z.a)
  C.BC = C.Aa : orthogonal_from (z.B)
  z.C,
  z.D = intersection (C.Aa,C.BC)
  C.AC = circle : new (z.A,z.C)
  z.T,
  z.Tp = C.AC : common_tangent (C.BC)
  L.TTp = line : new (z.T,z.Tp)
  z.M = C.AC : point (0.45)
  L.MC =line : new (z.M,z.C)
  z.Mp = intersection (L.MC, C.BC)
  L.mm = L.TTp : ll_from (z.C)
  _,z.M = intersection (L.mm, C.AC)
  z.Mp = intersection (L.mm, C.BC)
}
\begin{tikzpicture}
  \tkzGetNodes
  \tkzDrawCircles(A,C B,C)
  \tkzDrawSegments(M,M' A,C B,C A,B)
  \tkzDrawSegments[gray](D,M D,M' T,T')
  \tkzDrawPoints(A,B,C,D,M,M',T,T')
  \tkzLabelPoints(A,B,D,M)
  \tkzLabelPoints[above](C,M',T,T')
  \tkzMarkRightAngles(M',D,M A,C,B)
\end{tikzpicture}
```

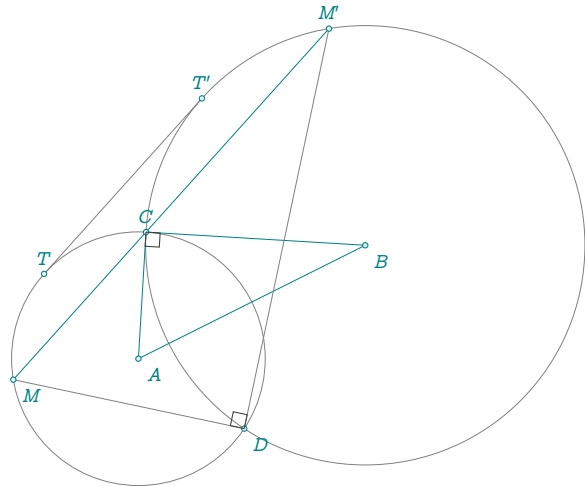

26.9 Apollonius circle

```
\directlua{%
  init_elements ()
  z.A = point: new (0 , 0)
  z.B = point: new (6 , 0)
  z.M = point: new (5 , 3)
  T.MAB = triangle : new (z.M,z.A,z.B)
  L.bis = T.MAB : bisector ()
  z.C = L.bis.pb
  L.bisext = T.MAB : bisector_ext ()
  z.D = intersection (T.MAB.bc, L.bisext)
  L.CD = line: new (z.C,z.D)
  z.O = L.CD.mid
  L.AM = T.MAB.ab
  z.E = z.M : symmetry (z.A)
}
\begin{tikzpicture}
  \tkzGetNodes
  \tkzDrawSegment[add=0 and 1](A,M)
```

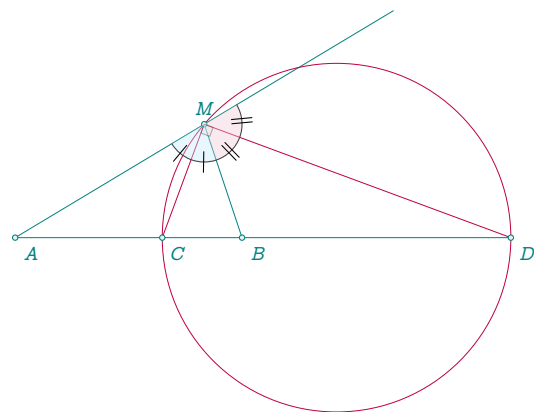

```

\tkzDrawSegments[purple](M,C M,D)
\tkzDrawCircle[purple](O,C)
\tkzDrawSegments(A,B B,M D,B)
\tkzDrawPoints(A,B,M,C,D)
\tkzLabelPoints[below right](A,B,C,D)
\tkzLabelPoints[above](M)
\tkzFillAngles[opacity=.4,cyan!20](A,M,B)
\tkzFillAngles[opacity=.4,purple!20](B,M,E)
\tkzMarkRightAngle[opacity=.4,fill=gray!20](C,M,D)
\tkzMarkAngles[mark=|](A,M,C C,M,B)
\tkzMarkAngles[mark=||](B,M,D D,M,E)
\end{tikzpicture}

```

Remark : The circle can be obtained with:

$C.AB = T.MAB.bc$: apollonius ($\text{length}(z.M,z.A)/\text{length}(z.M,z.B)$)

26.10 Apollonius and circle circumscribed

```

\directlua{%
init_elements ()
z.A = point: new (0 , 0)
z.B = point: new (6 , 0)
z.M = point: new (5 , 4)
T.AMB = triangle: new (z.A,z.M,z.B)
L.AB = T.AMB.ca
z.I = T.AMB.incenter
L.MI = line: new (z.M,z.I)
z.C = intersection (L.AB , L.MI)
L.MJ = L.MI: ortho_from (z.M)
z.D = intersection (L.AB , L.MJ)
L.CD = line: new (z.C,z.D)
z.O = L.CD.mid
z.G = T.AMB.circumcenter
C.GA = circle: new (z.G,z.A)
C.OC = circle: new (z.O,z.C)
_,z.N = intersection (C.GA , C.OC)
}
\begin{tikzpicture}[scale = .75]
\tkzGetNodes
\tkzDrawPolygon(A,B,M)
\tkzDrawCircles[purple](O,C G,A)
\tkzDrawSegments[purple](M,D)
\tkzDrawSegments(D,B O,G M,C)
\tkzDrawSegments[red,dashed](M,N M,O M,G)
\tkzDrawPoints(A,B,M,C,D,N,O,G)
\tkzLabelPoints[below right](A,B,C,D,N,O,G)
\tkzLabelPoints[above](M)
\tkzMarkRightAngle[opacity=.4,fill=gray!20](C,M,D)
\end{tikzpicture}

```

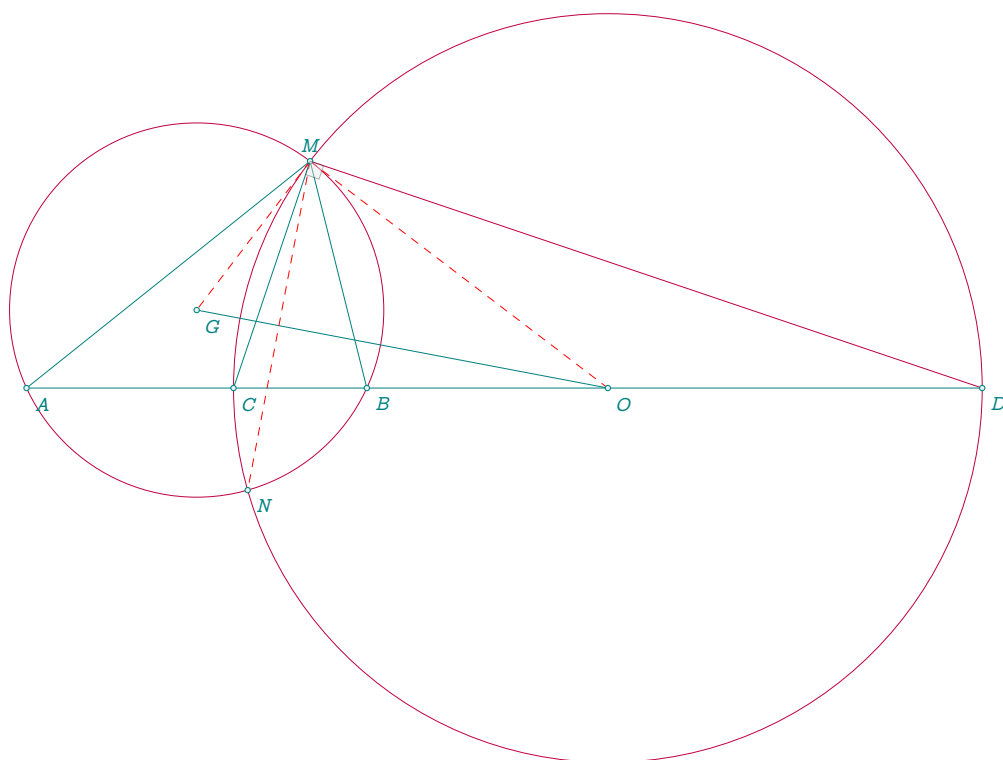
26.11 Apollonius circles in a triangle

```
\directlua{%
init_elements ()
  z.A = point: new (0 , 0)
  z.B = point: new (6 , 0)
  z.C = point: new (4.5 , 1)
  T.ABC = triangle: new (z.A,z.B,z.C)
  z.I = T.ABC.incenter
  z.O = T.ABC.circumcenter
  L.CI = line: new (z.C,z.I)
  z.Cp = intersection (T.ABC.ab , L.CI)
  z.x = L.CI.north_pa
  L.Cx = line: new (z.C,z.x)
  z.R = intersection (L.Cx,T.ABC.ab)
  L.CpR = line: new (z.Cp,z.R)
  z.O1 = L.CpR.mid
  L.AI = line: new (z.A,z.I)
  z.Ap = intersection (T.ABC.bc , L.AI)
  z.y = L.AI.north_pa
  L.Ay = line: new (z.A,z.y)
  z.S = intersection (L.Ay,T.ABC.bc)
  L.ApS = line: new (z.Ap,z.S)
  z.O2 = L.ApS.mid
  L.BI = line: new (z.B,z.I)
  z.Bp = intersection (T.ABC.ca , L.BI)
  z.z = L.BI.north_pa
  L.Bz = line: new (z.B,z.z)
  z.T = intersection (L.Bz,T.ABC.ca)
  L.Bpt = line: new (z.Bp,z.T)
  z.O3 = L.Bpt.mid
```

```

}

\begin{tikzpicture}
  \tkzGetNodes
  \tkzDrawCircles[blue!50!black] (O1,C' O2,A' O3,B')
  \tkzDrawSegments[new] (B,S C,T A,R)
  \tkzDrawPolygon(A,B,C)
  \tkzDrawPoints(A,B,C,A',B',C',O,I,R,S,T,O1,O2,O3)
  \tkzLabelPoints(A,B,C,A',B',C',O,I)
  \tkzLabelPoints(O1,O2,O3)
  \tkzDrawCircle[purple] (O,A)
  \tkzDrawLine(O1,O2)
\end{tikzpicture}

```

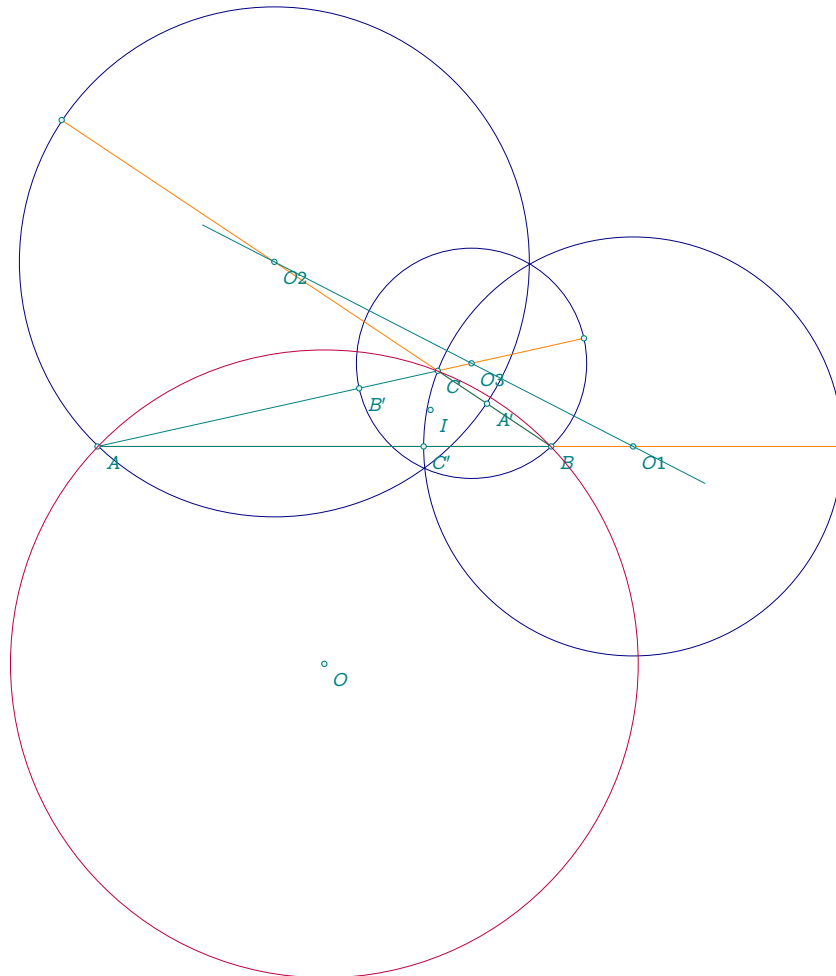

Same result using the function T.ABC.ab : apollonius (k)

```

\directlua{%
  init_elements ()
  z.A      = point: new (0 , 0)
  z.B      = point: new (6 , 0)
  z.C      = point: new (4.5 , 1)
  T.ABC    = triangle : new (z.A,z.B,z.C)
  z.O      = T.ABC.circumcenter
  C.AB     = T.ABC.ab : apollonius (length(z.C,z.A)/length(z.C,z.B))
  z.w1,z.t1 = get_points ( C.AB )
}

```

```

C.AC      = T.ABC.ca : apollonius (length(z.B,z.C)/length(z.B,z.A))
z.w2,z.t2 = get_points ( C.AC )
C.BC      = T.ABC.bc : apollonius (length(z.A,z.B)/length(z.A,z.C))
z.w3,z.t3 = get_points ( C.BC )
}

```

26.12 Archimedes

```

\directlua{%
init_elements ()
z.O_1 = point: new (0, 0)
z.O_2 = point: new (0, 1)
z.A   = point: new (0, 3)
z.F   = point: polar (3, math.pi/6)
L     = line: new (z.F,z.O_1)
C     = circle: new (z.O_1,z.A)
z.E   = intersection (L,C)
T     = triangle: new (z.F,z.E,z.O_2)
z.x   = T: parallelogram ()
L     = line: new (z.x,z.O_2)
C     = circle: new (z.O_2,z.A)
z.C,z.D = intersection (L ,C)
}
\begin{tikzpicture}
\tkzGetNodes
\tkzDrawCircles(O_1,A O_2,A)
\tkzDrawSegments[new](O_1,A E,F C,D)
\tkzDrawSegments[purple](A,E A,F)
\tkzDrawPoints(A,O_1,O_2,E,F,C,D)
\tkzLabelPoints(A,O_1,O_2,E,F,C,D)
\end{tikzpicture}

```

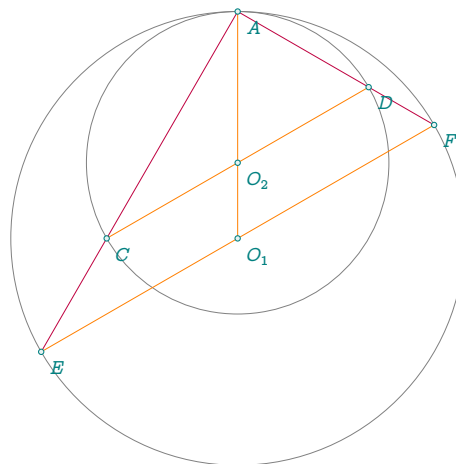

26.13 Bankoff circle

```

\directlua{%
init_elements ()
z.A = point: new (0 , 0)
z.B = point: new (10 , 0)
L.AB = line : new (z.A,z.B)
z.C = L.AB: gold_ratio ()
L.AC = line : new (z.A,z.C)
L.CB = line : new (z.C,z.B)
z.O_0 = L.AB.mid
z.O_1 = L.AC.mid
z.O_2 = L.CB.mid
C.O0B = circle : new (z.O_0,z.B)
C.O1C = circle : new (z.O_1,z.C)
C.O2C = circle : new (z.O_2,z.B)
z.Pp = C.O0B : midarc (z.B,z.A)
z.P = C.O1C : midarc (z.C,z.A)
z.Q = C.O2C : midarc (z.B,z.C)
L.O102 = line : new (z.O_1,z.O_2)
L.O001 = line : new (z.O_0,z.O_1)
L.O002 = line : new (z.O_0,z.O_2)
z.M_0 = L.O102 : harmonic_ext (z.C)
z.M_1 = L.O001 : harmonic_int (z.A)
}

```

```

z.M_2    = L.0002 : harmonic_int (z.B)
L.BP     = line : new (z.B,z.P)
L.AQ     = line : new (z.A,z.Q)
z.S      = intersection (L.BP,L.AQ)
L.Pp00   = line : new (z.Pp,z.O_0)
L.PC     = line : new (z.P,z.C)
z.Ap     = intersection (L.Pp00,L.PC)
L.CS     = line : new (z.C,z.S)
C.M1A    = circle : new (z.M_1,z.A)
C.M2B    = circle : new (z.M_2,z.B)
z.P_0    = intersection (L.CS,C.O0B)
z.P_1    = intersection (C.M2B,C.O1C)
z.P_2    = intersection (C.M1A,C.O2C)
T.POP1P2 = triangle : new (z.P_0,z.P_1,z.P_2)
z.O_4    = T.POP1P2.circumcenter
T.CP1P2  = triangle : new (z.C,z.P_1,z.P_2)
z.O_5    = T.CP1P2.circumcenter
}

\begin{tikzpicture}
\tkzGetNodes
\tkzDrawSemiCircles[teal](O_0,B)
\tkzDrawSemiCircles[teal,fill=teal!20,opacity=.5](O_1,C O_2,B)
\tkzDrawCircle[fill=green!10](O_4,P_0)
\tkzDrawCircle[purple,fill=purple!10,opacity=.5](O_5,C)
\tkzDrawSegments(A,B O_0,P' B,P A,Q)
\tkzDrawSegments(P,B Q,O_2 P,O_1)
\tkzDrawSegments[purple](O_5,P_2 O_5,P_1 O_5,C)
\tkzDrawPoints(A,B,C,P_0,P_2,P_1,O_0,O_1,O_2,O_4,O_5,Q,P,P',S)
\tkzLabelPoints[below](A,B,C,O_0,O_1,O_2,P')
\tkzLabelPoints[above](Q,P)
\tkzLabelPoints[above right](P_0,P_2,P_1,O_5,O_4,S)
\begin{scope}[font=\scriptsize]
\tkzLabelCircle[above](O_1,C)(120){\beta}
\tkzLabelCircle[above](O_2,B)(70){\gamma}
\tkzLabelCircle[above](O_0,B)(110){\alpha}
\tkzLabelCircle[left](O_4,P_2)(60){\delta}
\tkzLabelCircle[left](O_5,C)(140){\epsilon}
\end{scope}
\end{tikzpicture}

```

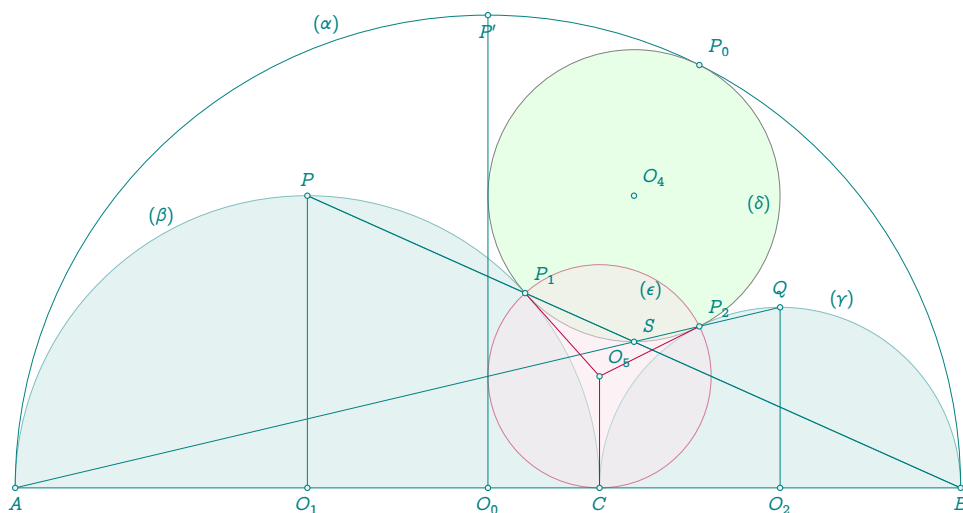

26.14 Symmedian property

L is the symmedian point or lemoine point. $\frac{CL}{CLc} = \frac{a^2 + b^2}{a^2 + b^2 + c^2}$

```
\directlua{%
  init_elements ()
  z.A      = point :   new (1,2)
  z.B      = point :   new (5,1)
  z.C      = point :   new (3,5)
  T.ABC    = triangle : new (z.A,z.B,z.C)
  T.SY     = T.ABC : symmedian ()
  z.La,
  z.Lb,
  z.Lc     = get_points (T.SY)
  k        = (T.ABC.a*T.ABC.a +
             T.ABC.b*T.ABC.b)/(T.ABC.a*T.ABC.a +
             T.ABC.b*T.ABC.b+T.ABC.c*T.ABC.c)
  L.SY     = line : new (z.C,z.Lc)
  z.L      = L.SY : point (k)
}
\begin{tikzpicture}
\tkzGetNodes
\tkzDrawPolygons(A,B,C)
\tkzDrawPoints(A,B,C,L,Lc)
\tkzDrawPoints[red](L)
\tkzDrawSegments[cyan](C,Lc)
\tkzLabelPoints(A,B,Lc)
\tkzLabelPoints[above](C)
\tkzLabelPoints[left](L)
\tkzLabelSegment(B,C){$a$}
\tkzLabelSegment(A,C){$b$}
\tkzLabelSegment(A,B){$ca$}
\end{tikzpicture}
```

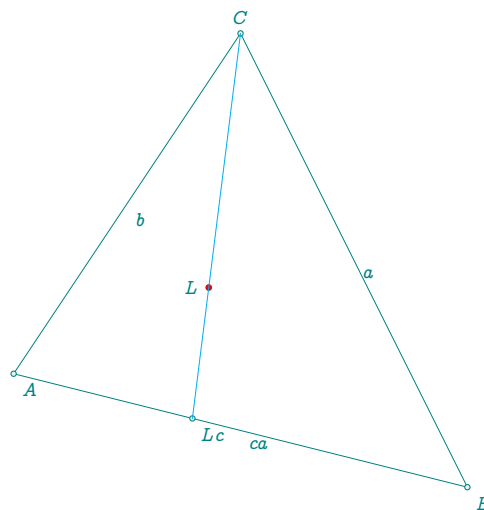

26.15 Example: Cevian with orthocenter

```

\directlua{%
  init_elements ()
  z.a = point: new (1,2)
  z.b = point: new (5,1)
  z.c = point: new (3,5)
  T = triangle: new (z.a,z.b,z.c)
  z.i = T.orthocenter
  T.cevian = T : cevian (z.i)
  z.ta,
  z.tb,
  z.tc = get_points (T.cevian)
  C.cev = T : cevian_circle (z.i)
  z.w = C.cev.center
}
\begin{tikzpicture}[scale = 1.5]
  \tkzGetNodes
  \tkzDrawPolygons(a,b,c ta,tb,tc)
  \tkzDrawSegments(a,ta b,tb c,tc)
  \tkzDrawPoints(a,b,c,i,ta,tb,tc)
  \tkzLabelPoints(a,b,c,i)
  \tkzDrawCircles(w,ta)
\end{tikzpicture}

```

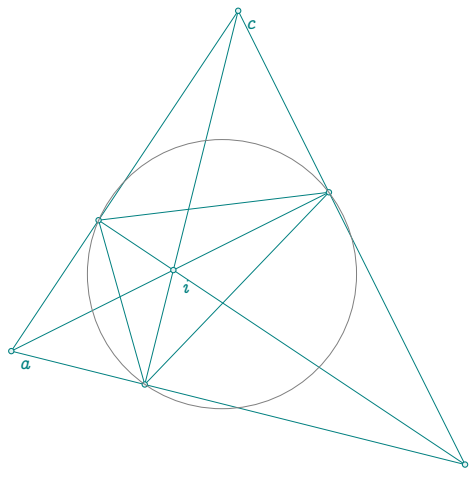

26.16 Excircles

```

\directlua{%
  init_elements ()
  z.A = point: new (0,0)
  z.B = point: new (6,0)
  z.C = point: new (.8,4)
  T = triangle: new ( z.A, z.B, z.C)
  z.K = T.centroid
  z.J_a,
  z.J_b,
  z.J_c = get_points (T: excentral())
  z.T_a,
  z.T_b,
  z.T_c = get_points (T: extouch())
  la = line: new ( z.A, z.T_a)
  lb = line: new ( z.B, z.T_b)
  z.G = intersection (la,lb)
}
\begin{tikzpicture}[scale = 0.7]
  \tkzGetNodes
  \tkzDrawPoints[new] (J_a,J_b,J_c)
  \tkzClipBB
  \tkzDrawCircles[gray] (J_a,T_a J_b,T_b J_c,T_c)
  \tkzDrawLines[add=1 and 1] (A,B B,C C,A)
  \tkzDrawSegments[new] (A,T_a B,T_b C,T_c)
  \tkzDrawSegments[new] (J_a,T_a J_b,T_b J_c,T_c)
  \tkzDrawPolygon(A,B,C)
  \tkzDrawPolygon[new] (T_a,T_b,T_c)
  \tkzDrawPoints(A,B,C,K)
  \tkzDrawPoints[new] (T_a,T_b,T_c)
  \tkzLabelPoints[below left] (A)

```

```

\tkzLabelPoints[below](B)
\tkzLabelPoints[above](C)
\tkzLabelPoints[new,below left](T_b)
\tkzLabelPoints[new,below right](T_c)
\tkzLabelPoints[new,right=6pt](T_a)
\tkzMarkRightAngles[fill=gray!15](J_a,T_a,B J_b,T_b,C J_c,T_c,A)
\end{tikzpicture}

```

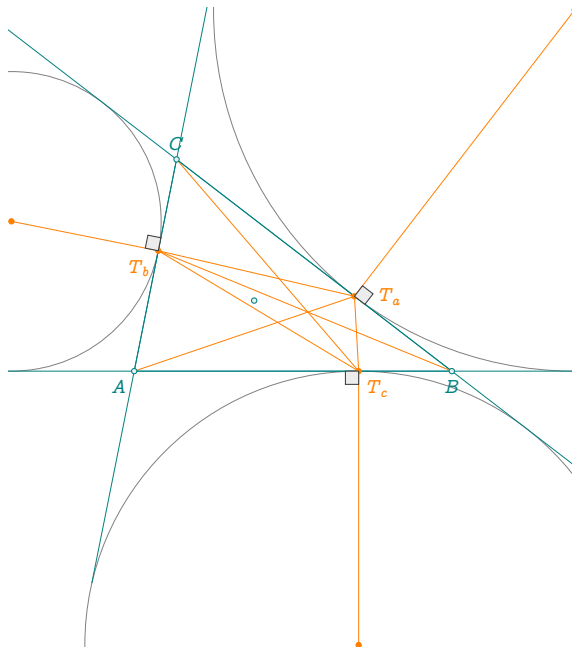

26.17 Divine ratio

```

\directlua{%
init_elements ()
z.A      = point: new (0 , 0)
z.B      = point: new (8 , 0)
L.AB     = line: new (z.A,z.B)
z.C      = L.AB: gold_ratio ()
L.AC     = line: new (z.A,z.C)
z.O_1    = L.AC.mid
_,_,z.G,z.H = get_points(L.AB: square ())
_,_,z.E,z.F = get_points(L.AC: square ())
L.CB     = line: new (z.C,z.B)
z.O_2    = L.CB.mid
z.O_0    = L.AB.mid
L.BE     = line: new (z.B,z.E)
L.GH     = line: new (z.G,z.H)
z.K      = intersection (L.BE,L.GH)
CO       = circle: new (z.O_0,z.B)
z.R,_    = intersection (L.BE,CO)
C2       = circle: new (z.O_2,z.B)
z.S,_    = intersection (L.BE,C2)
L.AR     = line: new (z.A,z.R)
C1       = circle: new (z.O_1,z.C)
_,z.T    = intersection (L.AR,C1)
L.BG     = line: new (z.B,z.G)
z.L      = intersection (L.AR,L.BG)

```

```

}
\begin{tikzpicture}
\tkzGetNodes
\tkzDrawPolygons(A,C,E,F A,B,G,H)
\tkzDrawCircles(O_1,C O_2,B O_0,B)
\tkzDrawSegments(H,C B,K A,L)
\tkzDrawPoints(A,B,C,K,E,F,G,H,O_0,O_1,O_2,R,S,T,L)
\tkzLabelPoints(A,B,C,K,E,F,G,H,O_0,O_1,O_2,R,S,T,L)
\end{tikzpicture}

```

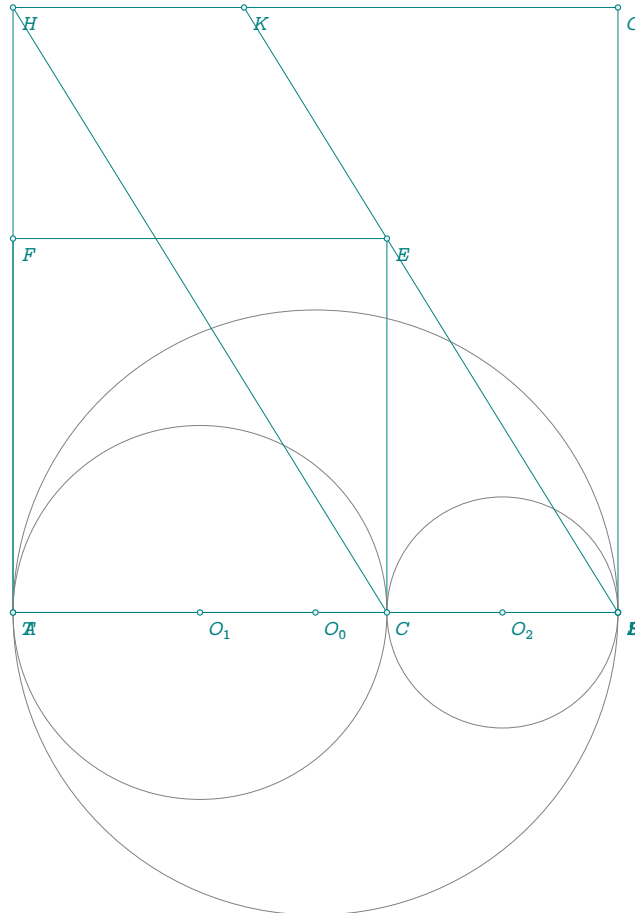

26.18 Director circle

```

\directlua{%
z.O      = point: new (0 , 0)
z.F1     = point: new (4 , 0)
z.F2     = point: new (-4 , 0)
z.H      = point: new (4*math.sqrt(2) , 0)
local a  = length(z.O,z.H)
E        = conic : new (EL_bifocal(z.F2,z.F1,a))
curve    = E : points(0,1,50)
z.A      = E.covertex
T.HOA    = triangle: new (z.H,z.O,z.A)
z.P      = T.HOA: parallelogram ()
C.OP     = circle: new (z.O,z.P)
z.L      = C.OP: point (0.25)
T.LJ ,T.LK = E: tangent_from (z.L)
}

```



```

z.J          = T.LJ.pb
z.K          = T.LK.pb
}
\begin{tikzpicture}
  \tkzGetNodes
  \tkzDrawPoints(F1,F2,O)
  \tkzDrawCircles[teal](O,P)
  \tkzDrawPolygon(H,O,A,P)
  \tkzDrawCoordinates[smooth,cyan](curve)
  \tkzDrawSegments[orange](O,P O,L L,J L,K)
  \tkzDrawPoints(F1,F2,O,H,A,P,L,J,K)
  \tkzLabelPoints(F1,F2,O,H,A,P,L,J,K)
\end{tikzpicture}

```

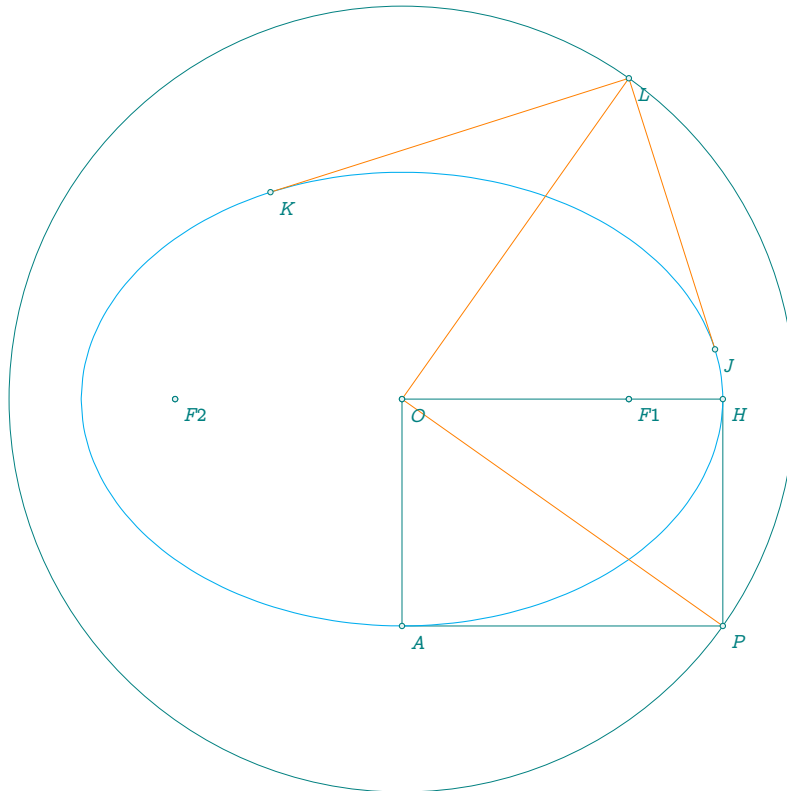

26.19 Gold division

```

\directlua{%
init_elements ()
z.A      = point: new (0,0)
z.B      = point: new (2.5,0)
L.AB     = line:  new (z.A,z.B)
C.AB     = circle: new (z.A,z.B)
C.BA     = circle: new (z.B,z.A)
z.J      = L.AB: midpoint ()
L.JB     = line:new (z.J,z.B)
z.F,z.E  = intersection (C.AB , C.BA)
z.I,_    = intersection (L.AB , C.BA)
z.K      = L.JB : midpoint ()
L.mediator = L.JB: mediator ()
z.G      = intersection (L.mediator,C.BA)
L.EG     = line:new (z.E,z.G)
z.C      = intersection (L.EG,L.AB)
z.O      = C.AB: antipode (z.B)
}
\begin{tikzpicture}
\tkzGetNodes
\tkzDrawArc[delta=5] (O,B) (G)
\tkzDrawCircles(A,B B,A)
\tkzDrawSegments(A,E B,E O,I)
\tkzDrawSegments[purple] (J,E A,G G,I K,G E,G)
\tkzMarkSegments[mark=s||] (A,E B,E O,A)
\tkzDrawPoints(A,B,C,E,I,J,G,O,K)
\tkzLabelPoints(A,B,C,E,I,J,G,O,K)
\end{tikzpicture}

```

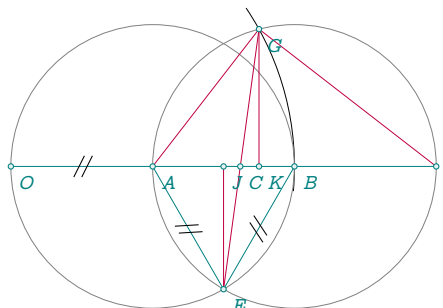

26.20 Ellipse

```

\directlua{%
init_elements ()
z.C      = point: new (3 , 2)
z.A      = point: new (5 , 1)
L.CA     = line : new (z.C,z.A)
z.b      = L.CA.north_pa
L        = line : new (z.C,z.b)
z.B      = L : point (0.5)
E        = conic : new (EL_points (z.C,z.A,z.B))
curve_E  = E : points(0,1,50)
z.F      = E.Fa
}

```

```

\begin{tikzpicture}
\tkzGetNodes
\tkzDrawCircles[teal] (C,A)
\tkzDrawCoordinates[smooth,red,thick] (curve_E)
\tkzLabelPoints(C,A)
\tkzLabelPoints[left] (F)
\end{tikzpicture}

```

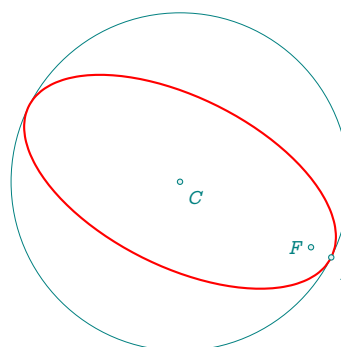

26.21 Ellipse with radii

In this example, K is the projection of the focus F on the directrix.

```

\directlua{%
init_elements ()
z.C = point: new (0 , 4)
local b = math.sqrt(8)
local a = math.sqrt(32)
local c = math.sqrt(a^2 - b^2)
local e = c / a
z.F = z.C:rotation(math.pi/4,z.C+point(c 0))
z.K = z.C:rotation(math.pi/4,z.C+point(a^2/c,0))
z.Kp = (z.K-z.C) : orthogonal(1):at (z.K)
L.dir= line : new (z.K,z.Kp)
E = conic : new (z.F,L.dir,e)
curve= E : points (0,1,50)
}
\begin{tikzpicture}[scale=.5]
\tkzGetNodes
\tkzDrawPoints(C,F,K)
\tkzLabelPoints(C,F,K)
\tkzDrawCoordinates[smooth](curve)
\end{tikzpicture}

```

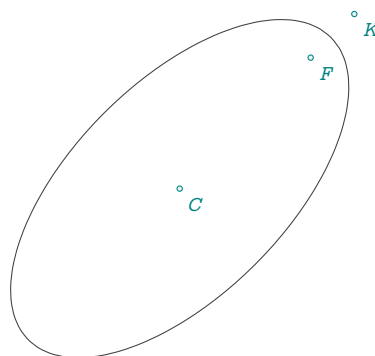

26.22 Ellipse_with_foci

```

\directlua{%
init_elements ()
local e = .8
z.A = point: new (2 , 3)
z.B = point: new (5 , 4)
z.K = point: new (6 , 7)
L.AB = line: new (z.A,z.B)
z.C = L.AB.mid
local c = point.abs(z.B-z.C)
local a = c/e
EL = conic : new (EL_bifocal (z.A,z.B,a))
curve = EL : points(0,1,50)
z.cV = EL.covertex
z.V = EL.vertex
L.ta,L.tb = EL: tangent_from (z.K)
z.F = L.ta.pb
z.G = L.tb.pb
}
\begin{tikzpicture}
\tkzGetNodes
\tkzDrawPoints(A,B,C,K,F,G,V,cV)
\tkzLabelPoints(A,B,C,K,F,G,V,cV)
\tkzDrawCoordinates[smooth,cyan](curve)
\tkzDrawLines(K,F K,G)
\end{tikzpicture}

```

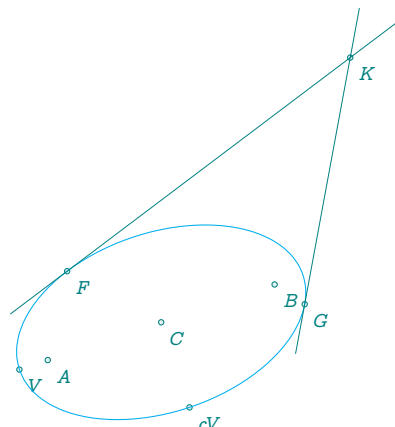

26.22.1 Kiepert hyperbola

In triangle geometry, the Kiepert conics are two special conics associated with the reference triangle. One of them is a hyperbola, called the Kiepert hyperbola and the other is a parabola, called the Kiepert parabola. It has been proved that the Kiepert hyperbola is the hyperbola passing through the vertices, the centroid and the orthocenter of the reference triangle [Wikipedia]

```

\directlua{

```

```

init_elements ()
z.A          = point: new(0,0)
z.B          = point: new(5,0)
z.C          = point: new(4,4)
T            = triangle: new (z.A,z.B,z.C)
z.K          = T : kimberling (115)
z.circumcenter = T.circumcenter
z.G          = T.centroid
L.brocard    = T : brocard_axis ()
C.circum     = circle : new (z.circumcenter,z.A)
z.M,z.N      = intersection(L.brocard,C.circum)
L.asx        = T : simson_line(z.M)
L.asy        = T : simson_line(z.N)
z.ux,z.uy    = get_points(L.asx)
z.vx,z.vy    = get_points(L.asy)
HY           = T : kiepert_hyperbola ()
curve        = HY : points(-3,3,50)
curveb       = HY : points(-3,3,50,swap)
z.F_a,z.F_b  = HY.Fa,HY.Fb
}
\begin{tikzpicture}
\tkzGetNodes
\tkzDrawPolygons(A,B,C)
\tkzDrawCoordinates[smooth](curve)
\tkzDrawCoordinates[smooth](curveb)
\tkzDrawLines(A,B A,C B,C F_a,F_b)
\tkzDrawLines[red,add = 8 and 5](K,vy)
\tkzDrawLines[red,add = 2 and 1](K,uy)
\tkzDrawPoints(A,B,C,K,G,F_a,F_b)
\tkzLabelPoints(A,B,C,G)
\tkzLabelPoints[right](F_a,F_b,K)
\end{tikzpicture}

```

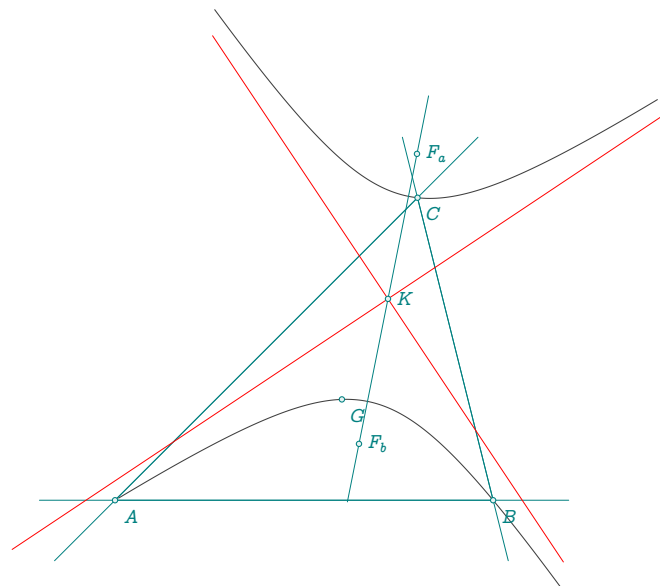

26.22.2 Kiepert parabola

The Euler line of a triangle is the conic section directrix of the Kiepert parabola. In fact, the directrices of all parabolas inscribed in a triangle pass through the orthocenter. The triangle formed by the points of contact is

called the Steiner triangle.

The Kiepert parabola is tangent to the sides of the triangle (or their extensions), the line at infinity, and the Lemoine axis. The focus of the parabola has is Kimberling center $X_1(110)$.

```
\directlua{%
  init_elements ()
  z.A      = point : new ( 0 , 0 )
  z.B      = point : new ( 6, 0 )
  z.C      = point : new ( 1.1, 4.5 )
  T        = triangle : new (z.A, z.B, z.C)
  z.H      = T.orthocenter
  z.O      = T.circumcenter
  kiepert = T :kiepert_parabola ()
  curve    = kiepert : points (-5,7,50)
  z.F      = kiepert.Fa
  z.S      = kiepert.vertex
  z.K      = kiepert.K
  z.a      = intersection (kiepert,T.ab)
  z.b      = intersection (kiepert,T.bc)
  z.c      = intersection (kiepert,T.ca)
}
\begin{tikzpicture}
  \tkzGetNodes
  \tkzDrawPolygon[cyan] (A,B,C)
  \tkzDrawPolygon[red] (a,b,c)
  \tkzDrawLines[purple,add = .5 and .5] (O,H K,F)
  \tkzDrawCoordinates[smooth,red] (curve)
  \tkzDrawPoints(A,B,C,F,O,H,K,a,b,c)
  \tkzDrawSegments(C,c C,b)
  \tkzLabelPoints(B,O,H,K,a,b)
  \tkzLabelPoints[above] (C)
  \tkzLabelPoints[left] (A)
  \tkzLabelPoints[right] (F,c)
\end{tikzpicture}
```

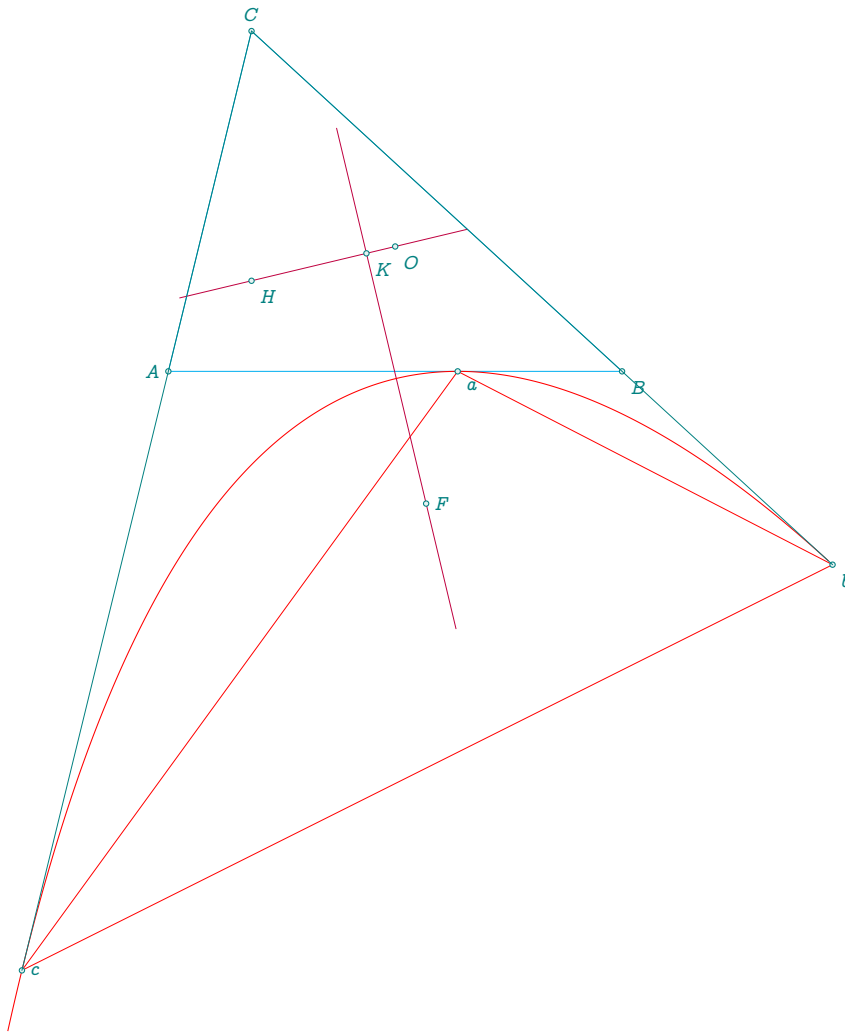

26.23 Euler relation

```

\directlua{%
init_elements ()
z.A      = point: new (0 , 0)
z.B      = point: new (5 , 0)
z.C      = point: new (-.4 , 4)
T.ABC    = triangle: new (z.A,z.B,z.C)
z.J,z.K  = get_points(T.ABC: ex_circle (2))
z.X,z.Y,z.K= T.ABC : projection (z.J)
z.I,z.H  = get_points(T.ABC : in_circle())
z.O      = T.ABC.circumcenter
C.OA     = circle : new (z.O,z.A)
T.IBA    = triangle: new (z.I,z.B,z.A)
z.w      = T.IBA.circumcenter
L.Ow     = line : new (z.O,z.w)
_,z.E    = intersection (L.Ow, C.OA)
}
\begin{tikzpicture}
\tkzGetNodes
\tkzDrawArc(J,X)(Y)
\tkzDrawCircles(I,H O,A)

```

26.24 External angle

```

\directlua{%
init_elements ()
  z.A   = point: new (0 , 0)
  z.B   = point: new (5 , 0)
  z.C   = point: new (-2 , 4)
  T.ABC = triangle: new (z.A,z.B,z.C)
  T.ext = T.ABC: excentral ()
  z.O   = T.ABC.circumcenter
  z.D   = intersection (T.ext.ab,T.ABC.ab)
  z.E   = z.C: symmetry (z.B)
}
\begin{tikzpicture}[scale = .5]
  \tkzGetNodes
  \tkzDrawPolygon(A,B,C)
  \tkzDrawLine[purple,add=0 and .5](B,C)
  \tkzDrawSegment[purple](A,D)
  \tkzDrawSegment[orange](C,D)
  \tkzFillAngles[purple!30,opacity=.2](D,C,A E,C,D)
  \tkzMarkAngles[mark=|](D,C,A E,C,D)
  \tkzDrawPoints(A,...,D)
  \tkzLabelPoints[above](C)
  \tkzLabelPoints(A,B,D)
\end{tikzpicture}

```

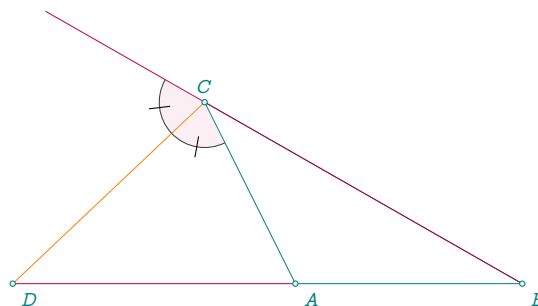

26.25 Internal angle

```

\directlua{%
init_elements ()
  z.A   = point: new (0 , 0)
  z.B   = point: new (6 , 0)
  z.C   = point: new (1 , 5)
  T     = triangle: new (z.A,z.B,z.C)
  z.I   = T.incenter
  L.AI  = line: new (z.A,z.I)
  z.D   = intersection (L.AI, T.bc)
  L.LL  = T.ab: ll_from (z.C)
  L.AD  = line: new (z.A,z.D)
  z.E   = intersection (L.LL,L.AD)
}
\begin{tikzpicture}[scale=.8]
  \tkzGetNodes
  \tkzDrawPolygon(A,B,C)
  \tkzDrawLine[purple](C,E)
  \tkzDrawSegment[purple](A,E)
  \tkzFillAngles[purple!30,opacity=.4](B,A,C C,E,D)
  \tkzMarkAngles[mark=|](B,A,D D,A,C C,E,D)
  \tkzDrawPoints(A,...,E)
  \tkzLabelPoints(A,B)
  \tkzLabelPoints[above](C,D,E)
  \tkzMarkSegments(A,C C,E)
\end{tikzpicture}

```

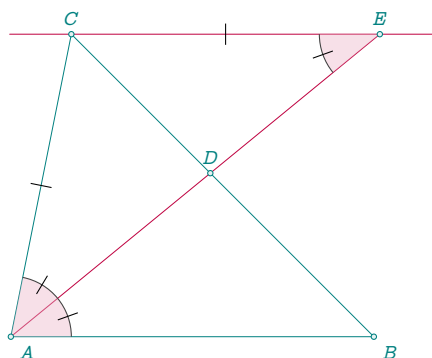

26.26 Feuerbach theorem

```

\directlua{%
init_elements ()
z.A      = point: new (0 , 0)
z.B      = point: new (5 , -.5)
z.C      = point: new (-.5 , 3)
T.ABC    = triangle: new (z.A,z.B,z.C)
z.O      = T.ABC.circumcenter
z.N      = T.ABC.eulercenter
z.I,z.K  = get_points(T.ABC: in_circle())
z.H      = T.ABC.ab : projection (z.I)
z.Ap,
z.Bp,
z.Cp    = get_points (T.ABC : medial ())
C.IH    = circle:new (z.I,z.H)
C.NAp   = circle:new (z.N,z.Ap)
C.OA    = circle:new (z.O,z.A)
z.U     = C.OA.south
z.L     = C.NAp.south
z.M     = C.NAp.north
z.X     = T.ABC.ab: projection (z.C)
L.CU    = line: new (z.C,z.U)
L.ML    = line: new (z.M,z.L)
z.P     = L.CU: projection (z.A)
z.Q     = L.CU: projection (z.B)
L.LH    = line: new (z.L,z.H)
z.F     = intersection (L.LH,C.IH) % feuerbach
}

\begin{tikzpicture}[scale = .8]
\tkzGetNodes
\tkzDrawLine(L,F)
\tkzDrawCircle[red](N,A')
\tkzDrawCircle[blue](I,H)
\tkzDrawCircles[teal](O,A L,C')
\tkzDrawSegments(M,L B,U Q,C C,X A,P B,Q)
\tkzDrawPolygons(A,B,C A',B',C')
\tkzDrawPoints(A,B,C,N,H,A',B',C',U,L,M,P,Q,F,I)
\tkzLabelPoints(A,B,C,N,H,A',B',C',U,L,M,P,Q,F,I)
\end{tikzpicture}

```

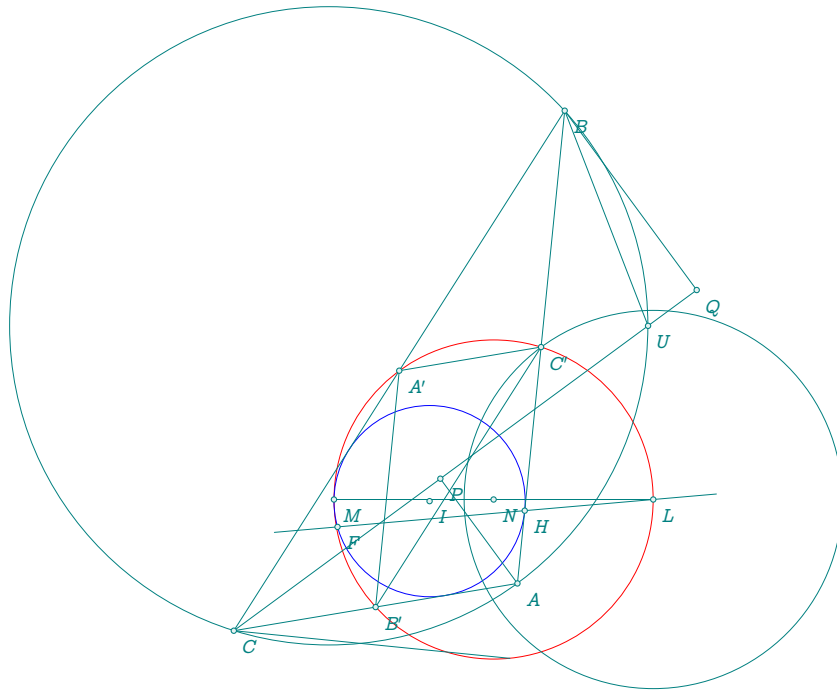

26.27 Gold ratio with segment

```

\directlua{%
  init_elements ()
  z.A = point: new (0 , 0)
  z.B = point: new (6 , 0)
  L.AB = line: new (z.A,z.B)
  _,_
  z.X,
  z.Y = get_points(L.AB: square ())
  L.BX = line: new (z.B,z.X)
  z.M = L.BX.mid
  C.MA = circle: new (z.M,z.A)
  _,z.K = intersection (L.BX,C.MA)
  L.AK = line: new (z.Y,z.K)
  z.C = intersection (L.AK,L.AB)
}
\begin{tikzpicture}[scale = .5]
  \tkzGetNodes
  \tkzDrawLines(A,B X,K)
  \tkzDrawLine[teal](Y,K)
  \tkzDrawPoints(A,B,C,X,Y,M,K)
  \tkzDrawArc[delta=20](M,A)(K)
  \tkzLabelPoints(A,B,C)
\end{tikzpicture}

```

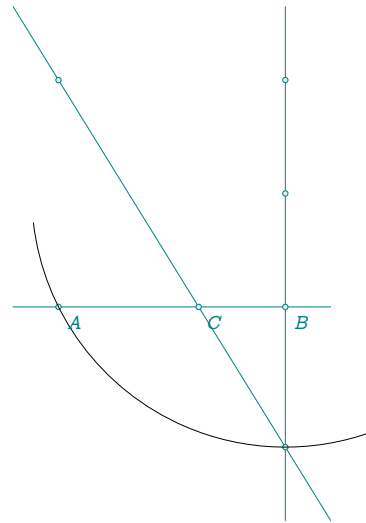

26.28 Gold Arbelos

```

\directlua{%
  init_elements ()
  z.A      = point: new (0 , 0)
  z.C      = point: new (6 , 0)
  L.AC     = line: new (z.A,z.C)
  --,--
  z.x,z.y = get_points(L.AC: square ())
  z.O_1    = L.AC . mid
  C        = circle: new (z.O_1,z.x)
  z.B      = intersection (L.AC,C)
  L.CB     = line: new (z.C,z.B)
  z.O_2    = L.CB.mid
  L.AB     = line: new (z.A,z.B)
  z.O_0    = L.AB.mid
}
\begin{tikzpicture}[ scale = .6]
  \tkzGetNodes
  \tkzDrawCircles(O_1,C O_2,B O_0,B)
  \tkzDrawPoints(A,C,B,O_1,O_2,O_0)
  \tkzLabelPoints(A,C,B)
\end{tikzpicture}

```

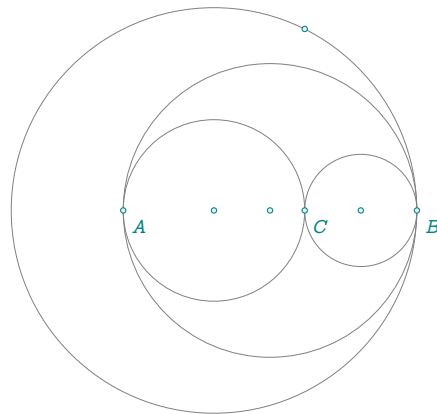

26.29 Harmonic division v1

```

\directlua{%
  init_elements ()
  z.A = point: new (0 , 0)
  z.B = point: new (4 , 0)
  z.G = point: new (2,2)
  L.AG = line : new (z.A,z.G)
  L.AB = line : new (z.A,z.B)
  z.E = L.AG : colinear_at (z.B, .5)
  L.GE = line : new (z.G,z.E)
  z.D = intersection (L.GE,L.AB)
  z.F = z.B : symmetry (z.E)
  L.GF = line :new (z.G,z.F)
  z.C = intersection (L.GF,L.AB)
}
\begin{tikzpicture}[ scale =.75]
  \tkzGetNodes
  \tkzDrawLines(A,B A,G A,D A,G F,E G,F G,D)
  \tkzDrawPoints(A,B,G,E,F,C,D)
  \tkzLabelPoints(A,B,G,E,F,C,D)
  \tkzMarkSegments(F,B B,E)
\end{tikzpicture}

```

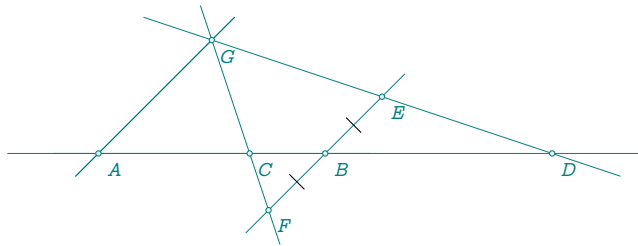

26.30 Harmonic division v2

```

\directlua{%
  init_elements ()
  z.A   = point: new (0 , 0)
  z.B   = point: new (6 , 0)
  z.D   = point: new (12 , 0)
  L.AB  = line: new (z.A,z.B)
  z.X   = L.AB.north_pa
  L.XB  = line: new (z.X,z.B)
  z.E   = L.XB.mid
  L.ED  = line: new (z.E,z.D)
  L.AX  = line: new (z.A,z.X)
  L.AE  = line: new (z.A,z.E)
  z.F   = intersection (L.ED,L.AX)
  L.BF  = line: new (z.B,z.F)
  z.G   = intersection (L.AE,L.BF)
  L.GX  = line: new (z.G,z.X)
  z.C   = intersection (L.GX,L.AB)
}
\begin{tikzpicture}[ scale = .5]
  \tkzGetNodes
  \tkzDrawLines(A,D A,E B,F D,F X,A X,B X,C)
  \tkzDrawPoints(A,...,G,X)
  \tkzLabelPoints(A,...,G,X)
\end{tikzpicture}

```

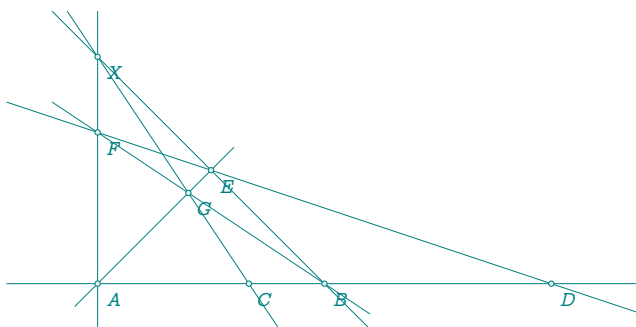

26.31 Menelaus

```

\directlua{%
  init_elements ()
  z.A   = point: new (0 , 0)
  z.B   = point: new (6 , 0)
  z.C   = point: new (5 , 4)
  z.P   = point: new (-1 , 0)
  z.X   = point: new (6 , 3)
  L.AC  = line: new (z.A,z.C)
  L.PX  = line: new (z.P,z.X)
  L.BC  = line: new (z.B,z.C)
  z.Q   = intersection (L.AC,L.PX)
  z.R   = intersection (L.BC,L.PX)
}
\begin{tikzpicture}
  \tkzGetNodes
  \tkzDrawPolygon(A,B,C)
  \tkzDrawLine[new](P,R)
  \tkzDrawLines(P,B A,C B,C)
  \tkzDrawPoints(P,Q,R,A,B,C)
  \tkzLabelPoints(A,B,C,P,Q,R)
\end{tikzpicture}

```

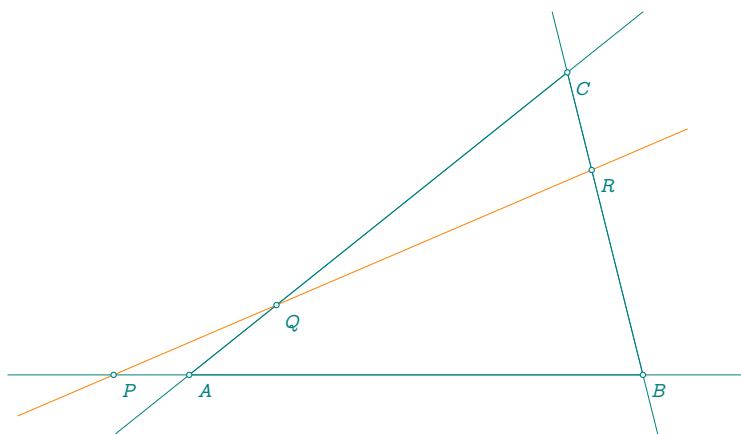

26.32 Euler ellipse

```

\directlua{%
init_elements ()
z.A      = point: new (2,3.8)
z.B      = point: new (0 ,0)
z.C      = point: new (6.2 ,0)
L.AB     = line  : new (z.A,z.B)
T.ABC    = triangle: new (z.A,z.B,z.C)
z.N      = T.ABC.eulercenter
z.G      = T.ABC.centroid
z.O      = T.ABC.circumcenter
z.H      = T.ABC.orthocenter
z.Ma,z.Mb,
z.Mc     = get_points (T.ABC : medial ())
z.Ha,z.Hb,
z.Hc     = get_points (T.ABC : orthic ())
z.Ea,z.Eb,
z.Ec     = get_points (T.ABC: extouch())
L.euler  = T.ABC : euler_line ()
C.circum = T.ABC : circum_circle ()
C.euler  = T.ABC : euler_circle ()
z.I,z.J  = intersection (L.euler,C.euler)
local a  = .5* length(z.I,z.J)
E        = conic: new (EL_bifocal(z.O,z.H,a))
curve    = E : points (0,1,50)
L.AH     = line: new (z.A,z.H)
L.BH     = line: new (z.B,z.H)
L.CH     = line: new (z.C,z.H)
z.X      = intersection (L.AH,C.circum)
_,z.Y    = intersection (L.BH,C.circum)
_,z.Z    = intersection (L.CH,C.circum)
L.BC     = line: new (z.B,z.C)
L.XO     = line: new (z.X,z.O)
L.YO     = line: new (z.Y,z.O)
L.ZO     = line: new (z.Z,z.O)
z.x      = intersection (L.BC,L.XO)
z.U      = intersection (L.XO,E)
_,z.V    = intersection (L.YO,E)
_,z.W    = intersection (L.ZO,E)
}

\begin{tikzpicture}
\tkzGetNodes
\tkzDrawPolygon(A,B,C)
\tkzDrawCircles[red] (N,Ma O,A)
\tkzDrawCoordinates[smooth,cyan] (curve)
\tkzDrawSegments(A,X B,Y C,Z B,Hb C,Hc X,O Y,O Z,O)
\tkzDrawPolygon[red] (U,V,W)
\tkzLabelPoints[red] (U,V,W)
\tkzLabelPoints(A,B,C,X,Y,Z)
\tkzDrawLine[blue] (I,J)
\tkzLabelPoints[blue,right] (O,N,G,H,I,J)
\tkzDrawPoints(I,J,U,V,W)
\tkzDrawPoints(A,B,C,N,G,H,O,X,Y,Z,Ma,Mb,Mc,Ha,Hb,Hc)
\end{tikzpicture}

```

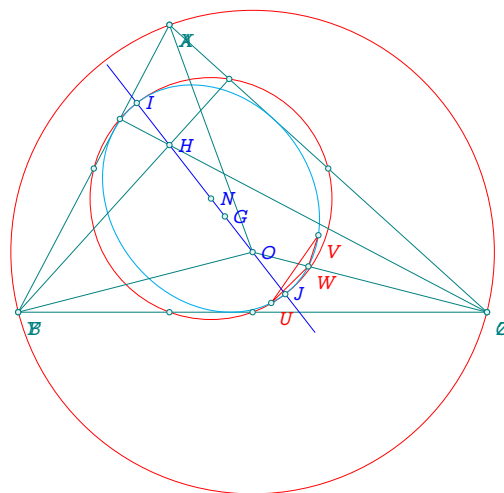

26.33 Gold Arbelos properties

```

\directlua{%
init_elements ()
z.A      = point : new(0,0)
z.B      = point : new(10,0)
z.C      = gold_segment_ (z.A,z.B)
L.AB     = line:new (z.A,z.B)
z.O_1    = L.AB.mid
L.AC     = line:new (z.A,z.C)
z.O_2    = L.AC.mid
L.CB     = line:new (z.C,z.B)
z.O_3    = L.CB.mid
C1       = circle:new (z.O_1,z.B)
C2       = circle:new (z.O_2,z.C)
C3       = circle:new (z.O_3,z.B)
z.Q      = C2.north
z.P      = C3.north
L1       = line:new (z.O_2,z.O_3)
z.M_0    = L1:harmonic_ext (z.C)
L2       = line:new (z.O_1,z.O_2)
z.M_1    = L2:harmonic_int (z.A)
L3       = line:new (z.O_1,z.O_3)
z.M_2    = L3:harmonic_int (z.B)
Lbq      = line:new (z.B,z.Q)
Lap      = line:new (z.A,z.P)
z.S      = intersection (Lbq,Lap)
z.x      = z.C: north ()
L        = line : new (z.C,z.x)
z.D,_    = intersection (L,C1)
L.CD     = line :new (z.C,z.D)
z.O_7    = L.CD.mid
C.DC     = circle: new (z.D,z.C)
z.U,z.V = intersection (C.DC,C1)
L.UV     = line :new (z.U,z.V)
z.R,z.S = L.UV : projection (z.O_2,z.O_3)
L.O1D   = line : new (z.O_1,z.D)
z.W      = intersection (L.UV,L.O1D)
z.O      = C.DC : inversion (z.W)
}

\begin{tikzpicture}
\tkzGetNodes
\tkzDrawCircles[teal](O_1,B)
\tkzDrawSemiCircles[thin,teal](O_2,C O_3,B)
\tkzDrawArc[purple,delta=0](D,V)(U)
\tkzDrawCircle[new](O_7,C)
\tkzDrawSegments[thin,purple](A,D D,B C,R C,S C,D U,V)
\tkzDrawSegments[thin,red](O,D A,O O,B)
\tkzDrawPoints(A,B,C,D,O_7) %,
\tkzDrawPoints(O_1,O_2,O_3,U,V,R,S,W,O)
\tkzDrawSegments[cyan](O_3,S O_2,R)
\tkzDrawSegments[very thin](A,B)
\tkzDrawSegments[cyan,thin](C,U U,D)
\tkzMarkRightAngles[size=.2,fill=gray!40,opacity=.4](D,C,A A,D,B
D,S,C D,W,V O_3,S,U O_2,R,U)
\tkzFillAngles[cyan!40,opacity=.4](B,A,D A,D,O_1

```

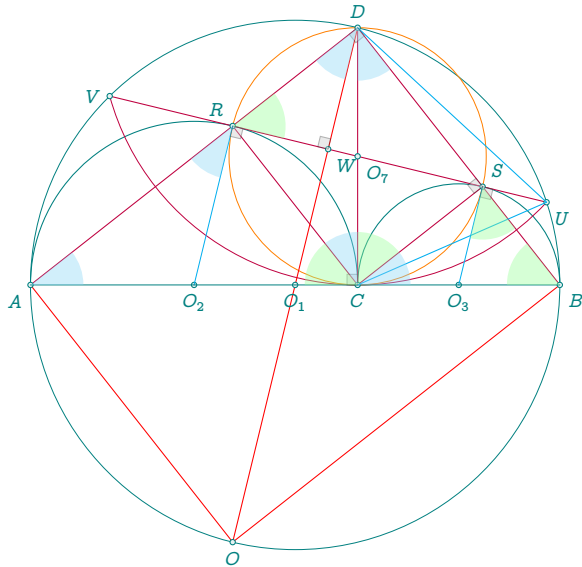

```

    C,D,B D,C,R B,C,S A,R,0_2)
\tkzFillAngles[green!40,opacity=.4](S,C,D W,R,D
    D,B,C R,C,A 0_3,S,B)
\tkzLabelPoints[below](C,0_2,0_3,0_1)
\tkzLabelPoints[above](D)
\tkzLabelPoints[below](O)
\tkzLabelPoints[below left](A)
\tkzLabelPoints[above left](R)
\tkzLabelPoints[above right](S)
\tkzLabelPoints[left](V)
\tkzLabelPoints[below right](B,U,W,0_7)
\end{tikzpicture}

```

26.34 Apollonius circle v1 with inversion

```

\directlua{%
init_elements ()
  z.A          = point: new (0,0)
  z.B          = point: new (6,0)
  z.C          = point: new (0.8,4)
  T.ABC        = triangle : new ( z.A,z.B,z.C )
  z.N          = T.ABC.eulercenter
  z.Ea,z.Eb,z.Ec = get_points ( T.ABC : feuerbach () )
  z.Ja,z.Jb,z.Jc = get_points ( T.ABC : excentral () )
  z.S          = T.ABC : spieker_center ()
  C.JaEa       = circle : new (z.Ja,z.Ea)
  C.ortho      = circle : radius (z.S,math.sqrt(C.JaEa : power (z.S) ))
  z.a          = C.ortho.south
  C.euler      = T.ABC: euler_circle ()
  C.apo        = C.ortho : inversion (C.euler)
  z.O          = C.apo.center
  z.xa,z.xb,z.xc = C.ortho : inversion (z.Ea,z.Eb,z.Ec)
}
\begin{tikzpicture}[scale= .7]
  \tkzGetNodes
  \tkzDrawCircles[red](O,xa N,Ea)
  \tkzFillCircles[green!30!black,opacity=.3](O,xa)
  \tkzFillCircles[yellow!30,opacity=.7](Ja,Ea Jb,Eb Jc,Ec)
  \tkzFillCircles[teal!30!black,opacity=.3](S,a)
  \tkzFillCircles[green!30,opacity=.3](N,Ea)
  \tkzDrawPoints[red](Ea,Eb,Ec,xa,xb,xc,N)
  \tkzClipCircle(O,xa)
  \tkzDrawLines[add=3 and 3](A,B A,C B,C)
  \tkzDrawCircles(Ja,Ea Jb,Eb Jc,Ec)
  \tkzFillCircles[lightgray!30,opacity=.7](Ja,Ea Jb,Eb Jc,Ec)
  \tkzDrawCircles[teal](S,a)
  \tkzDrawPoints(A,B,C,O)
  \tkzDrawPoints[teal](S)
  \tkzLabelPoints(A,B,C,O,S,N)
\end{tikzpicture}

```

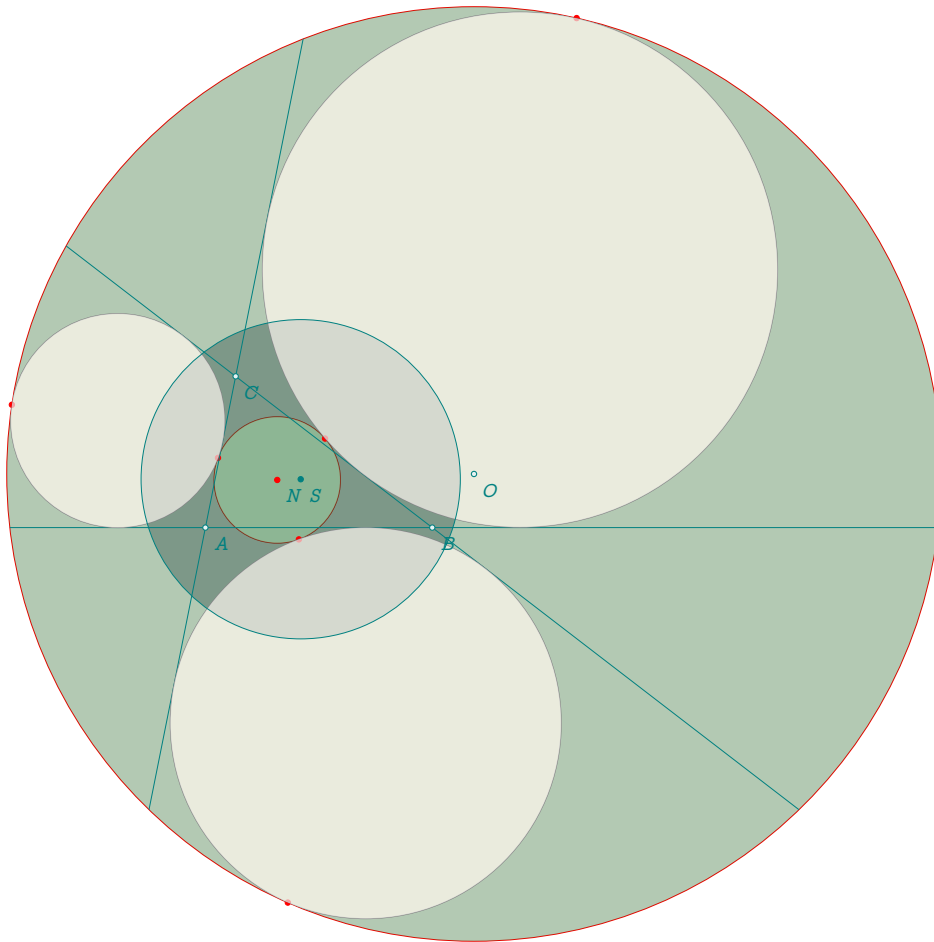

26.35 Apollonius circle v2

```

\directlua{
init_elements ()
  z.A      = point: new (0,0)
  z.B      = point: new (6,0)
  z.C      = point: new (0.8,4)
  T.ABC    = triangle: new(z.A,z.B,z.C)
  z.O      = T.ABC.circumcenter
  z.H      = T.ABC.orthocenter
  z.G      = T.ABC.centroid
  z.L      = T.ABC: lemoine_point ()
  z.S      = T.ABC: spieker_center ()
  C.euler  = T.ABC: euler_circle ()
  z.N,z.Ma = get_points (C.euler)
  C.exA    = T.ABC : ex_circle ()
  z.Ja,z.Xa = get_points (C.exA)
  C.exB    = T.ABC : ex_circle (1)
  z.Jb,z.Xb = get_points (C.exB)
  C.exC    = T.ABC : ex_circle (2)
  z.Jc,z.Xc = get_points (C.exC)
  L.OL     = line: new (z.O,z.L)
  L.NS     = line: new (z.N,z.S)
  z.o      = intersection (L.OL,L.NS) % center of Apollonius circle
  L.NMa    = line: new (z.N,z.Ma)

```



```

L.ox      = L.NMa: ll_from (z.o)
L.MaS     = line: new (z.Ma,z.S)
z.t       = intersection (L.ox,L.MaS) % through
}

\begin{tikzpicture}[scale= .5]
  \tkzGetNodes
  \tkzDrawLines[add=1 and 1](A,B A,C B,C)
  \tkzDrawCircles(Ja,Xa Jb,Xb Jc,Xc o,t N,Ma) %
  \tkzClipCircle(o,t)
  \tkzDrawLines[red](o,L N,o Ma,t)
  \tkzDrawLines[cyan,add=4 and 4](Ma,N o,t)
  \tkzDrawPoints(A,B,C,Ma,Ja,Jb,Jc)
  \tkzDrawPoints[red](N,O,L,S,o,t)
  \tkzLabelPoints[right,font=\tiny](A,B,C,Ja,Jb,Jc,O,N,L,S,Ma,o)
\end{tikzpicture}

```

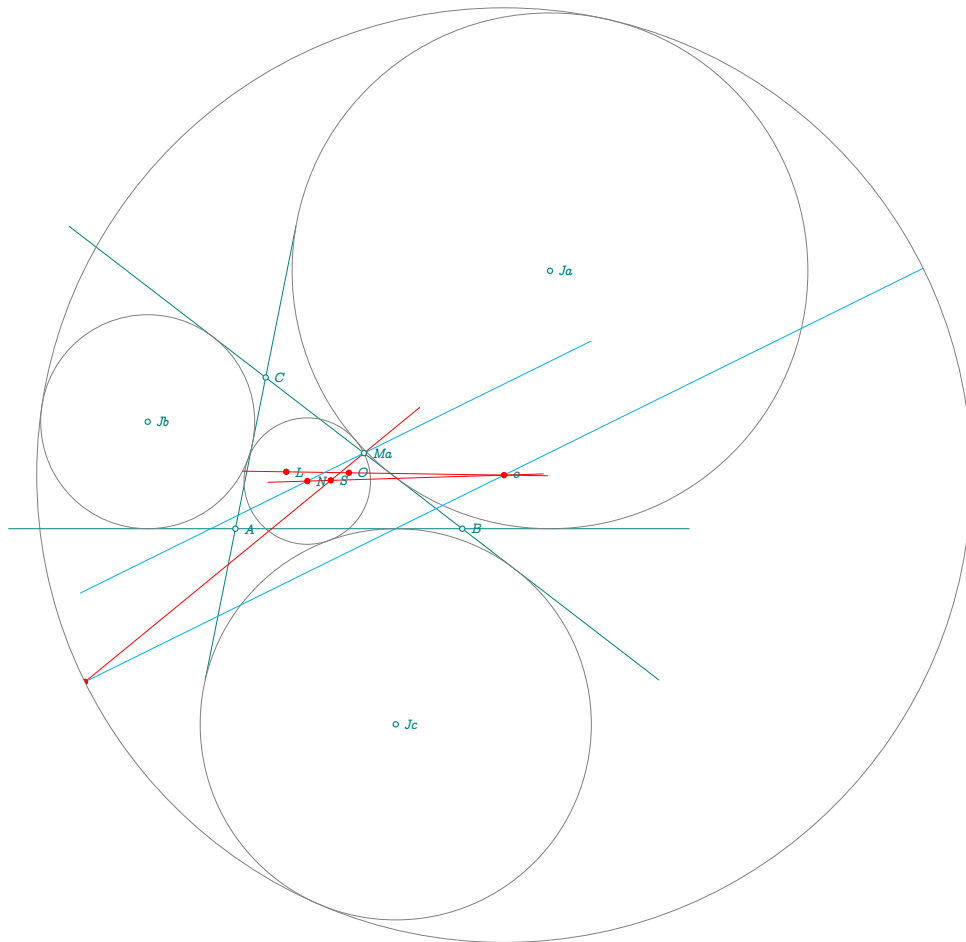

26.36 Orthogonal circles

```

\directlua{%
init_elements ()
z.O      = point: new (2,2)
z.Op     = point: new (-4,1)
z.P      = point: polar (4,0)
C.OP     = circle: new (z.O,z.P)
C.Oz1    = C.OP : orthogonal_from (z.Op)
z.z1     = C.Oz1.through
L.OP     = line : new (z.O,z.P)
C.Opz1   = circle: new (z.Op,z.z1)
L.T,L.Tp = C.Opz1 : tangent_from (z.O)
z.T      = L.T.pb
z.Tp     = L.Tp.pb
L.OOp    = line : new (z.O,z.Op)
z.M      = L.OOp.mid
}
\begin{tikzpicture}[ scale = .5]
\tkzGetNodes
\tkzDrawCircle[red] (O,P)
\tkzDrawCircle[purple] (O',z1)
\tkzDrawCircle[cyan] (M,T)
\tkzDrawSegments(O',T O,T' O',T')
\tkzDrawSegment[purple] (O',T)
\tkzDrawSegments[red] (O,T O,O')
\tkzDrawPoints(O,O',T,T',M)
\tkzMarkRightAngle[fill=gray!10] (O',T,O)
\tkzLabelPoint[below] (O){$O$}
\tkzLabelPoint[above] (T){$T$}
\tkzLabelPoint[above] (M){$M$}
\tkzLabelPoint[below] (T'){$T'$}
\tkzLabelPoint[above left] (O'){$O'$}
\end{tikzpicture}

```

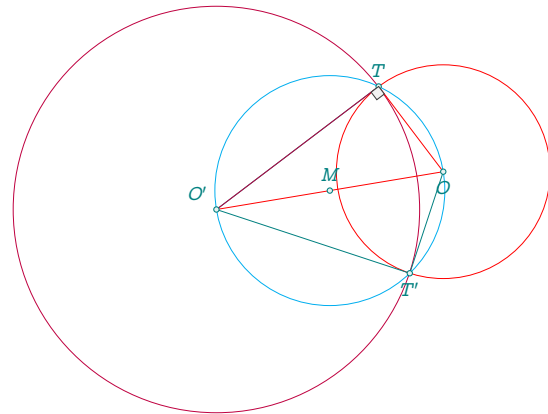

26.37 Orthogonal circle to two circles

```

\directlua{%
init_elements ()
z.O      = point :   new (-1,0)
z.B      = point :   new (0,2)
z.Op     = point :   new (4,-1)
z.D      = point :   new (4,0)
C.OB     = circle :  new (z.O,z.B)
C.OpD    = circle :  new (z.Op,z.D)
z.E,z.F  = get_points (C.OB : radical_axis (C.OpD))
L.EF     = line :    new (z.E,z.F)
z.M      = L.EF :    point (.25)
L.T,L.Tp = C.OB :    tangent_from (z.M)
L.K,L.Kp = C.OpD :   tangent_from (z.M)
z.T      = L.T.pb
z.K      = L.K.pb
z.Tp     = L.Tp.pb
z.Kp     = L.Kp.pb
}
\begin{tikzpicture}[scale = .75]
\tkzGetNodes
\tkzDrawCircles(O,B O',D)
\tkzDrawLine[cyan](E,F)
\tkzDrawLines[add=.5 and .5,orange](O,O' O,T O,T')
\tkzDrawSegments[cyan](M,T M,T' M,K M,K')
\tkzDrawCircle(M,T)
\tkzDrawPoints(O,O',T,M,T',K,K')
\tkzLabelPoints(O,O',T,T',M,K,K')
\end{tikzpicture}

```

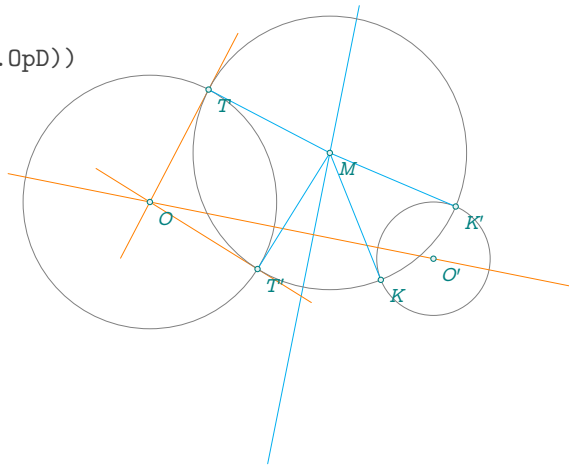

26.38 Midcircles

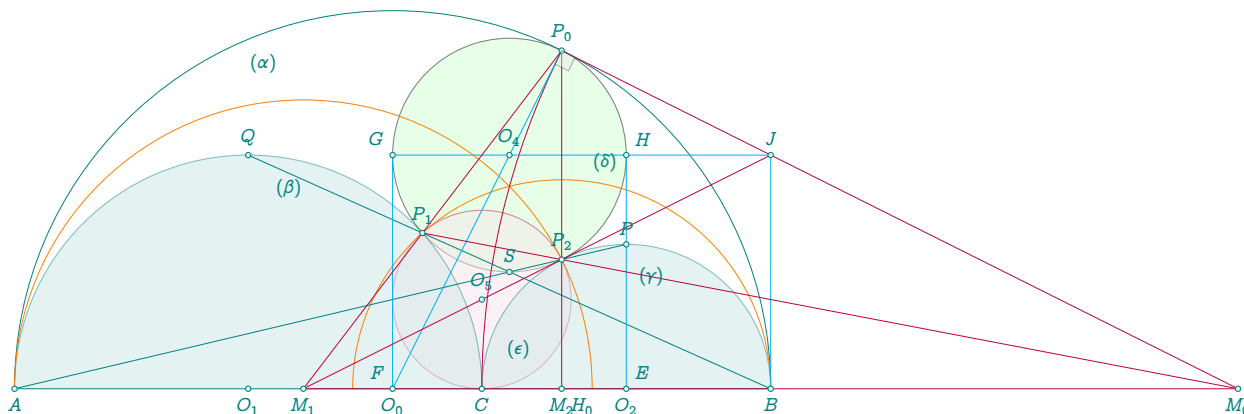

```

\directlua{%
init_elements ()
z.A      = point: new (0 , 0)
z.B      = point: new (10 , 0)
L.AB     = line : new (z.A,z.B)
z.C      = L.AB: gold_ratio ()
L.AC     = line : new (z.A,z.C)
L.CB     = line : new (z.C,z.B)
z.O_0    = L.AB.mid

```

```

z.O_1 = L.AC.mid
z.O_2 = L.CB.mid
C.O0B = circle : new (z.O_0,z.B)
C.O1C = circle : new (z.O_1,z.C)
C.O2C = circle : new (z.O_2,z.B)
z.Q = C.O1C : midarc (z.C,z.A)
z.P = C.O2C : midarc (z.B,z.C)
L.O102 = line : new (z.O_1,z.O_2)
L.O001 = line : new (z.O_0,z.O_1)
L.O002 = line : new (z.O_0,z.O_2)
z.M_0 = L.O102 : harmonic_ext (z.C)
z.M_1 = L.O001 : harmonic_int (z.A)
z.M_2 = L.O002 : harmonic_int (z.B)
L.BQ = line : new (z.B,z.Q)
L.AP = line : new (z.A,z.P)
z.S = intersection (L.BQ,L.AP)
L.CS = line : new (z.C,z.S)
C.M1A = circle : new (z.M_1,z.A)
C.M2B = circle : new (z.M_2,z.B)
z.P_0 = intersection (L.CS,C.O0B)
z.P_1 = intersection (C.M2B,C.O1C)
z.P_2 = intersection (C.M1A,C.O2C)
T.P012 = triangle : new (z.P_0,z.P_1,z.P_2)
z.O_4 = T.P012.circumcenter
T.CP12 = triangle : new (z.C,z.P_1,z.P_2)
z.O_5 = T.CP12.circumcenter
z.BN = z.B : north ()
L.BBN = line : new (z.B,z.BN)
L.M1P2 = line : new (z.M_1,z.P_2)
z.J = intersection (L.BBN,L.M1P2)
L.AP0 = line : new (z.A,z.P_0)
L.BP0 = line : new (z.B,z.P_0)
C.O4P0 = circle : new (z.O_4,z.P_0)
_,z.G = intersection (L.AP0,C.O4P0)
z.H = intersection (L.BP0,C.O4P0)
z.Ap = z.M_1: symmetry (z.A)
z.H_4,z.F,z.E,z.H_0 = L.AB : projection (z.O_4,z.G,z.H,z.P_0)
}

\begin{tikzpicture}
\tkzGetNodes
\tkzDrawCircle[thin,fill=green!10](O_4,P_0)
\tkzDrawCircle[purple,fill=purple!10,opacity=.5](O_5,C)
\tkzDrawSemiCircles[teal](O_0,B)
\tkzDrawSemiCircles[thin,teal,fill=teal!20,opacity=.5](O_1,C O_2,B)
\tkzDrawSemiCircles[color = orange](M_2,B)
\tkzDrawSemiCircles[color = orange](M_1,A')
\tkzDrawArc[purple,delta=0](M_0,P_0)(C)
\tkzDrawSegments[very thin](A,B A,P B,Q)
\tkzDrawSegments[color=cyan](O_0,P_0 B,J G,J G,O_0 H,O_2)
\tkzDrawSegments[ultra thin,purple](M_1,P_0 M_2,P_0 M_1,M_0 M_0,P_1 M_0,P_0 M_1,J)
\tkzDrawPoints(A,B,C,P_0,P_2,P_1,M_0,M_1,M_2,J,P,Q,S)
\tkzDrawPoints(O_0,O_1,O_2,O_4,O_5,G,H)
\tkzMarkRightAngle[size=.2,fill=gray!20,opacity=.4](O_0,P_0,M_0)
\tkzLabelPoints[below](A,B,C,M_0,M_1,M_2,O_1,O_2,O_0)
\tkzLabelPoints[above](P_0,O_5,O_4)

```

```

\tkzLabelPoints[above](P_1,J)
\tkzLabelPoints[above](P_2,P,Q,S)
\tkzLabelPoints[above right](H,E)
\tkzLabelPoints[above left](F,G)
\tkzLabelPoints[below right](H_0)
\tkzLabelCircle[below=4pt,font=\scriptsize](O_1,C)(80){$(\beta)$}
\tkzLabelCircle[below=4pt,font=\scriptsize](O_2,B)(80){$(\gamma)$}
\tkzLabelCircle[below=4pt,font=\scriptsize](O_0,B)(110){$(\alpha)$}
\tkzLabelCircle[left,font=\scriptsize](O_4,P_2)(60){$(\delta)$}
\tkzLabelCircle[above left,font=\scriptsize](O_5,C)(40){$(\epsilon)$}
\end{tikzpicture}

```

26.39 Pencil v1

```

\directlua{%
init_elements ()
  z.A      = point : new (0,2)
  z.B      = point : new (0,-2)
  z.C_0    = point : new (-3,0)
  z.C_1    = point : new (2,0)
  z.C_3    = point : new (2.5,0)
  z.C_5    = point : new (1,0)
  L.BA     = line : new (z.B,z.A)
  z.M_0    = L.BA : point (1.25)
  z.M_1    = L.BA : point (1.5)
  C.COA    = circle : new (z.C_0,z.A)
  z.x,z.y  = get_points (C.COA : orthogonal_from (z.M_0))
  z.xp,z.yp = get_points (C.COA : orthogonal_from (z.M_1))
  z.O      = L.BA.mid
}

```

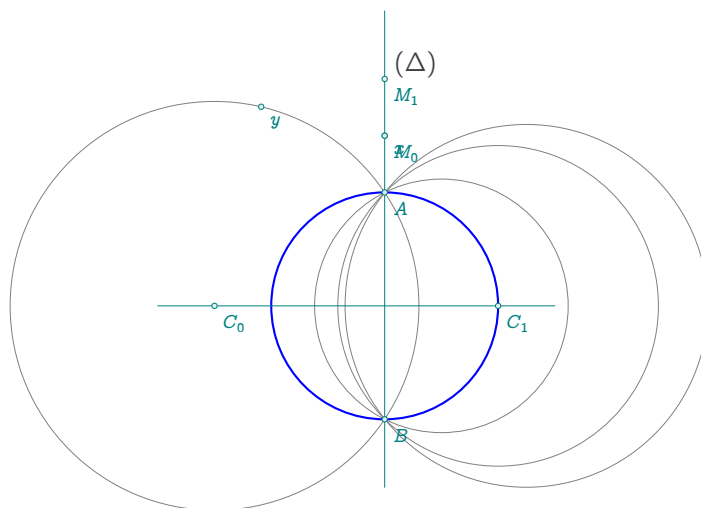

```

\begin{tikzpicture}[scale=.75]
\tkzGetNodes
\tkzDrawCircles(C_0,A C_1,A C_3,A C_5,A)
\tkzDrawCircles[thick,color=red](M_0,x M_1,x')
\tkzDrawCircles[thick,color=blue](O,A)
\tkzDrawLines(C_0,C_1 B,M_1)
\tkzDrawPoints(A,B,C_0,C_1,M_0,M_1,x,y)
\tkzLabelPoints[below right](A,B,C_0,C_1,M_0,M_1,x,y)

```

```
\tkzLabelLine[pos=1.25,right]( M_0,M_1){$(\Delta)$}
\end{tikzpicture}
```

26.40 Pencil v2

```
\directlua{%
init_elements ()
  z.A      = point : new (0,0)
  z.B      = point : new (1,0)
  z.C_0    = point : new (-2,0)
  z.C_1    = point : new (4,0)
  C.C0A    = circle : new (z.C_0,z.A)
  C.C1B    = circle : new (z.C_1,z.B)
  L.EF     = C.C0A : radical_axis (C.C1B)
  z.M_0    = L.EF : point (.4)
  z.M_1    = L.EF : point (.1)
  z.M_2    = L.EF : point (.6)
  C.orth0  = C.C0A : orthogonal_from (z.M_0)
  C.orth1  = C.C0A : orthogonal_from (z.M_1)
  C.orth2  = C.C0A : orthogonal_from (z.M_2)
  z.u      = C.orth0.through
  z.v      = C.orth1.through
  z.t      = C.orth2.through
}
```

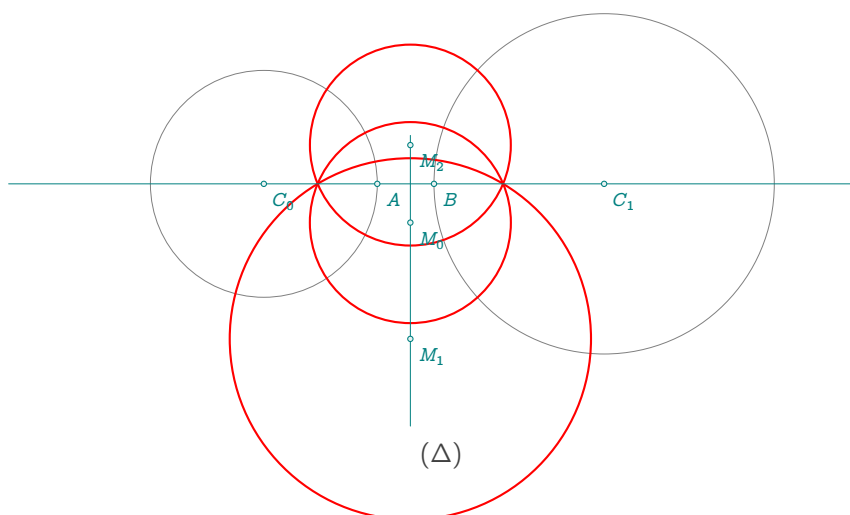

```
\begin{tikzpicture}[scale=.75]
\tkzGetNodes
\tkzDrawCircles(C_0,A C_1,B)
\tkzDrawCircles[thick,color=red](M_0,u M_1,v M_2,t)
\tkzDrawLines[add= .75 and .75](C_0,C_1 M_0,M_1)
\tkzDrawPoints(A,B,C_0,C_1,M_0,M_1,M_2)
\tkzLabelPoints[below right](A,B,C_0,C_1,M_0,M_1,M_2)
\tkzLabelLine[pos=2,right]( M_0,M_1){$(\Delta)$}
\end{tikzpicture}
```

26.41 Reim v1

```
\directlua{%
init_elements ()
z.A = point: new (0,0)
z.E = point: new (-2,2)
C.AE = circle : new (z.A,z.E)
z.C = C.AE : point (0.65)
z.D = C.AE : point (0.5)
z.F = C.AE : point (0.30)
L.EC = line: new (z.E,z.C)
z.H = L.EC : point (1.5)
T.CDH = triangle : new (z.C,z.D,z.H)
z.B = T.CDH.circumcenter
C.BD = circle : new (z.B,z.D)
L.FD = line: new (z.F,z.D)
z.G = intersection (L.FD,C.BD)
z.O = intersection (L.EC,L.FD)
}
```

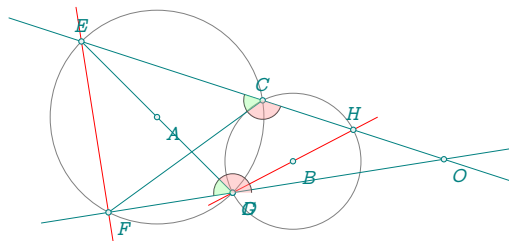

```
\begin{tikzpicture}
\tkzGetNodes
\tkzDrawCircles(A,E B,H)
\tkzDrawSegments(E,D C,F)
\tkzDrawLines(E,O F,O)
\tkzDrawLines[red](E,F H,G)
\tkzDrawPoints(A,...,H,O)
\tkzLabelPoints(A,B,D,F,G,O)
\tkzLabelPoints[above](E,C,H)
\tkzMarkAngles[size=.5](E,C,F E,D,F)
\tkzFillAngles[green!40,opacity=.4,size=.5](E,C,F E,D,F)
\tkzMarkAngles[size=.5](F,C,H G,D,E)
\tkzFillAngles[red!40,opacity=.4,size=.5](F,C,H G,D,E)
\end{tikzpicture}
```

26.42 Reim v2

```
\directlua{%
init_elements ()
z.A = point: new (0,0)
z.B = point: new (10,0)
z.C = point: new (4,0)
C.AC = circle: new (z.A,z.C)
z.c,z.cp = get_points (C.AC: tangent_at (z.C))
z.M = C.AC: point (0.6)
L.MC = line: new (z.M,z.C)
C.BC = circle: new (z.B,z.C)
z.N = intersection (L.MC,C.BC)
z.m,z.mp = get_points (C.AC: tangent_at (z.M))
z.n,z.np = get_points (C.BC: tangent_at (z.N))
}
```

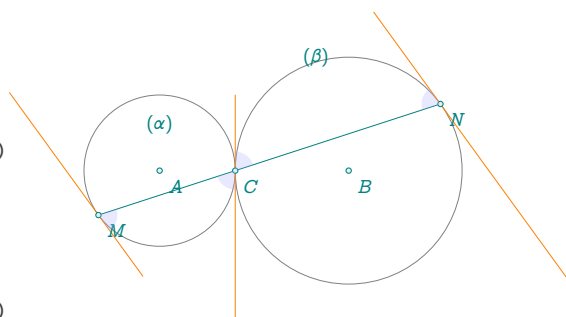

```
\begin{tikzpicture}[scale = .25]
\tkzGetNodes
\tkzDrawCircles(A,C B,C)
\tkzDrawLines[new,add=1 and 1](M,m N,n C,c)
\tkzDrawSegment(M,N)
\tkzDrawPoints(A,B,C,M,N)
\tkzLabelPoints[below right](A,B,C,M,N)
\end{tikzpicture}
```

```

\tkzFillAngles[blue!30,opacity=.3](m',M,C N,C,c' M,C,c n',N,C)
\tkzLabelCircle[below=4pt,font=\scriptsize](A,C)(90){$(\alpha)$}
\tkzLabelCircle[left=4pt,font=\scriptsize](B,C)(-90){$(\beta)$}
\end{tikzpicture}

```

26.43 Reim v3

```

\directlua{%
init_elements ()
  z.A      = point: new (0,0)
  z.B      = point: new (8,0)
  z.C      = point: new (2,6)
  L.AB     = line : new (z.A,z.B)
  L.AC     = line : new (z.A,z.C)
  L.BC     = line : new (z.B,z.C)
  z.I      = L.BC : point (0.75)
  z.J      = L.AC : point (0.4)
  z.K      = L.AB : point (0.5)
  T.AKJ    = triangle : new (z.A,z.K,z.J)
  T.BIK    = triangle : new (z.B,z.I,z.K)
  T.CIJ    = triangle : new (z.C,z.I,z.J)
  z.x      = T.AKJ.circumcenter
  z.y      = T.BIK.circumcenter
  z.z      = T.CIJ.circumcenter
  C.xK     = circle: new (z.x,z.K)
  C.yK     = circle: new (z.y,z.K)
  z.O,_    = intersection (C.xK,C.yK)
  C.zO     = circle: new (z.z,z.O)
  L.KO     = line: new (z.K,z.O)
  z.D      = intersection (L.KO,C.zO)
}
\begin{tikzpicture}
\tkzGetNodes
\tkzDrawSegments(K,D D,C)
\tkzDrawPolygon[teal](A,B,C)
\tkzDrawCircles[orange](x,A y,B z,C)
\tkzDrawPoints[fill=white](A,B,C,I,J,K,D)
\tkzLabelPoints[below](A,B,J,K,O)
\tkzLabelPoints[above](C,D,I)
\tkzDrawPoints[fill=black](O)
\tkzLabelCircle[below=4pt,font=\scriptsize](x,A)(20){$(\alpha)$}
\tkzLabelCircle[left=4pt,font=\scriptsize](y,B)(60){$(\beta)$}
\tkzLabelCircle[below=4pt,font=\scriptsize](z,C)(60){$(\gamma)$}
\end{tikzpicture}

```

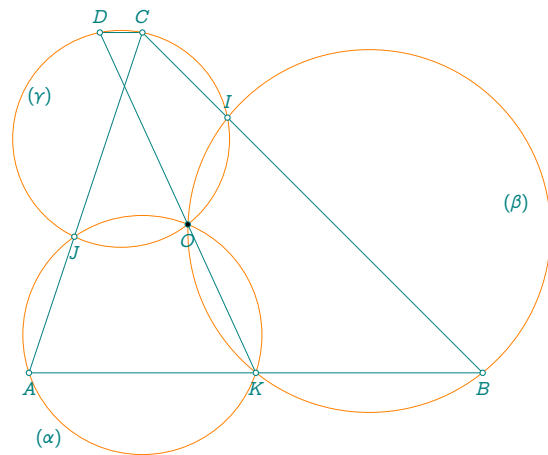

26.44 Tangent and circle

```

\directlua{%
init_elements ()
  z.A      = point:  new (1,0)
  z.B      = point:  new (2,2)
  z.E      = point:  new (5,-4)
  L.AE     = line :  new (z.A,z.E)
  C.AB     = circle: new (z.A , z.B)
  z.S      = C.AB.south
  z.M      = L.AE.mid
  L.Ti,L.Tj = C.AB:  tangent_from (z.E)
  z.i      = L.Ti.pb
  z.j      = L.Tj.pb
  z.k,z.l  = get_points (C.AB:  tangent_at (z.B))
}
\begin{tikzpicture}[scale = .75]
  \tkzGetNodes
  \tkzDrawCircles(A,B M,A)
  \tkzDrawPoints(A,B,E,i,j,M,S)
  \tkzDrawLines(E,i E,j k,l)
  \tkzLabelPoints[right,font=\small](A,B,E,S,M)
\end{tikzpicture}

```

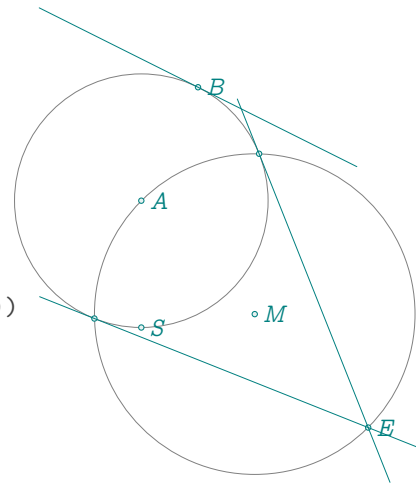

26.45 Homothety

```

\directlua{%
init_elements ()
  z.A      = point:  new (0,0)
  z.B      = point:  new (1,2)
  z.E      = point:  new (-3,2)
  z.C,z.D  = z.E : homothety(2,z.A,z.B)
}
\begin{tikzpicture}
  \tkzGetNodes
  \tkzDrawPoints(A,B,C,E,D)
  \tkzLabelPoints(A,B,C,E)
  \tkzDrawCircles(A,B C,D)
  \tkzDrawLines(E,C E,D)
\end{tikzpicture}

```

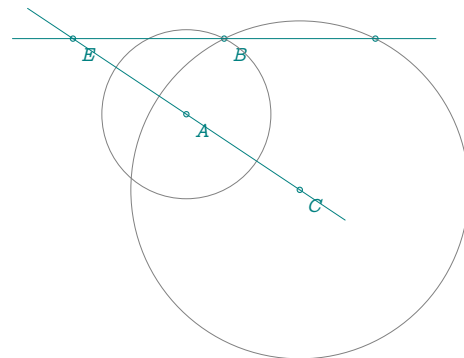

26.46 Tangent and chord

```

\directlua{%
init_elements ()
z.A      = point: new (0 , 0)
z.B      = point: new (6 , 0)
z.C      = point: new (1 , 5)
z.Bp     = point: new (2 , 0)
T.ABC    = triangle: new (z.A,z.B,z.C)
L.AB     = line: new (z.A,z.B)
z.O      = T.ABC.circumcenter
C.OA     = circle: new (z.O,z.A)
z.D      = C.OA: point (4.5)
L.AO     = line: new (z.A,z.O)
z.b1,z.b2 = get_points(C.OA: tangent_at(z.B))
z.H      = L.AB: projection (z.O)
}
\begin{tikzpicture}[scale = 0.75]
\tkzGetNodes
\tkzDrawCircle(O,A)
\tkzDrawPolygon(A,B,C)
\tkzDrawSegments[new] (A,O B,O O,H A,D D,B)
\tkzDrawLine(b1,b2)
\tkzDrawPoints(A,B,C,D,H,O)
\tkzFillAngles[green!20,opacity=.3] (H,O,B A,C,B A,B,b1)
\tkzFillAngles[teal!20,opacity=.3] (A,D,B b2,B,A)
\tkzLabelPoints(A,B,C,D,H,O)
\end{tikzpicture}

```

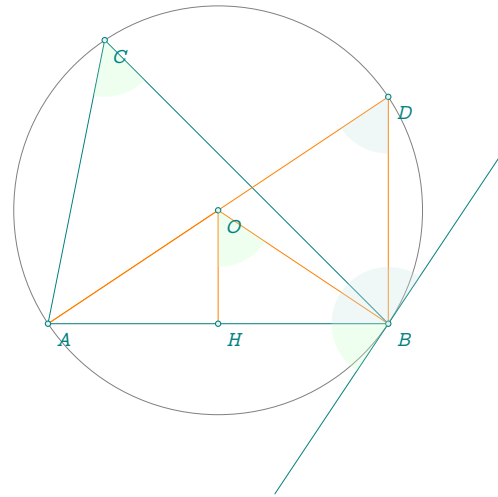

26.47 Three chords

```

\directlua{%
init_elements ()
z.O = point: new (0 , 0)
z.B = point: new (0 , 2)
z.P = point: new (1 , -.5)
C.OB = circle : new (z.O,z.B)
C.PB = circle : new (z.P,z.B)
_,z.A = intersection (C.OB,C.PB)
z.D = C.PB: point(0.85)
z.C = C.PB: point(0.5)
z.E = C.OB: point(0.6)
L.AB = line : new (z.A,z.B)
L.CD = line : new (z.C,z.D)
z.G = intersection (L.AB,L.CD)
L.GE = line : new (z.G,z.E)
z.F,_ = intersection (L.GE,C.OB)
T.CDE = triangle: new (z.C,z.D,z.E)
T.BFD = triangle: new (z.B,z.F,z.D)
z.w = T.CDE.circumcenter
z.x = T.BFD.circumcenter
L.GB = line : new (z.G,z.B)
L.GE = line : new (z.G,z.E)
L.GD = line : new (z.G,z.D)
C.xB = circle : new (z.x,z.B)
C.xF = circle : new (z.x,z.F)
C.xD = circle : new (z.x,z.D)
z.Ap = intersection (L.GB,C.xB)
z.Ep,_ = intersection (L.GE,C.xF)
z.Cp,_ = intersection (L.GD,C.xD)
}

\begin{tikzpicture}
\tkzGetNodes
\tkzDrawCircles(O,B)
\tkzDrawCircles[cyan](P,B)
\tkzDrawCircles[red](w,E)
\tkzDrawCircles[new](x,F)
\tkzDrawSegments(A,G E,G C,G)
\tkzDrawPolygons[new](A,E,C A',E',C')
\tkzDrawPoints(A,...,G,A',E',C',O,P)
\begin{scope}[font=\scriptsize]
\tkzLabelPoints(A,...,F)
\tkzLabelPoints[above left](G,A',E',C')
\tkzLabelCircle[left](O,B)(30){$(\beta)$}
\tkzLabelCircle[below](P,A)(40){$(\gamma)$}
\tkzLabelCircle[right](w,C)(90){$(\alpha)$}
\tkzLabelCircle[left](x,B)(-230){$(\delta)$}
\end{scope}
\end{tikzpicture}

```

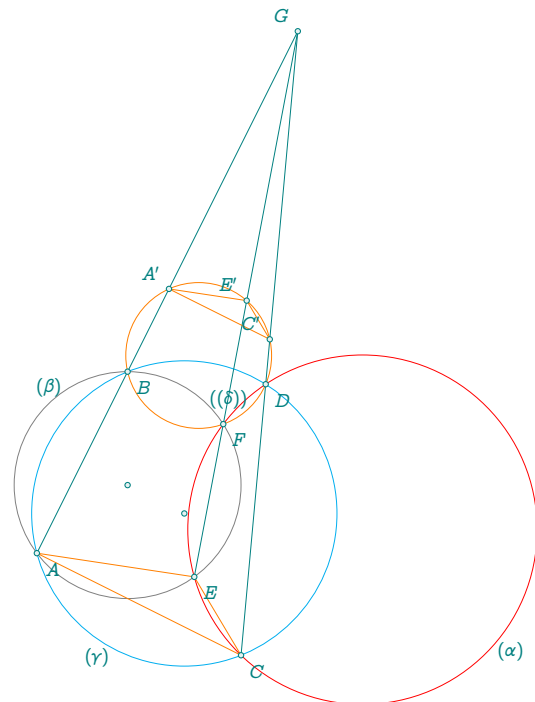

26.48 Three tangents

```

\directlua{%
init_elements ()
  z.A   = point: new (-1 , 0)
  z.C   = point: new (4 , -1.5)
  z.E   = point: new (1 , -1)
  z.F   = point: new (1.5 , 2.5)
  T.AEF = triangle : new (z.A,z.E,z.F)
  T.CEF = triangle : new (z.C,z.E,z.F)
  z.w   = T.AEF.circumcenter
  z.x   = T.CEF.circumcenter
  C.wE  = circle : new (z.w,z.E)
  C.xE  = circle : new (z.x,z.E)
  L.Aw  = line : new (z.A,z.w)
  L.Cx  = line : new (z.C,z.x)
  z.G   = intersection (L.Aw,L.Cx)
  L.TA  = C.wE : tangent_at (z.A)
  L.TC  = C.xE : tangent_at (z.C)
  z.I   = intersection (L.TA,L.TC)
}
\begin{tikzpicture}
  \tkzGetNodes
  \tkzDrawCircles(w,E)
  \tkzDrawCircles[cyan](x,E)
  \tkzDrawCircles[red](G,A)
  \tkzDrawLines(A,I C,I F,I)
  \tkzDrawPoints(A,C,E,F)
  \tkzLabelPoints[right](A)
  \tkzLabelPoints[above right](E,F)
  \tkzLabelPoints[below](C)
\end{tikzpicture}

```

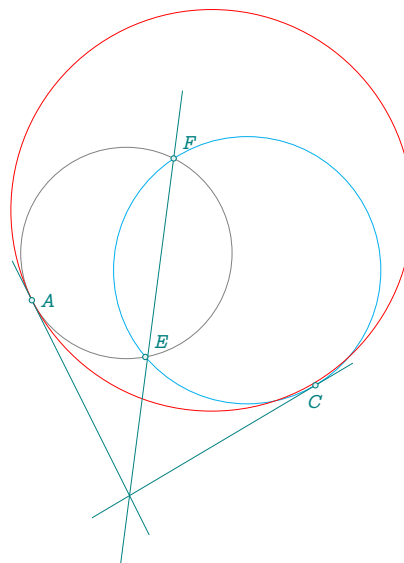

26.49 Midarc

```

\directlua{%
init_elements ()
  z.A   = point: new (-1,0)
  z.B   = point: new (2,4)
  C.AB  = circle: new (z.A,z.B)
  z.C   = z.A: rotation (math.pi/3,z.B)
  z.D   = C.AB: midarc (z.B,z.C)
}
\begin{tikzpicture}
  \tkzGetNodes
  \tkzDrawPoints(A,B,C)
  \tkzDrawCircles(A,B)
  \tkzDrawPoints(A,...,D)
  \tkzLabelPoints(A,...,D)
\end{tikzpicture}

```

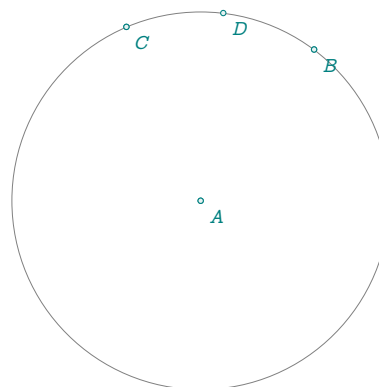

26.50 Lemoine axis without macro

```

\directlua{%
init_elements ()
  z.A      = point: new (1,0)
  z.B      = point: new (5,2)
  z.C      = point: new (1.2,2)
  T        = triangle: new(z.A,z.B,z.C)
  z.O      = T.circumcenter
  L.AB     = line: new (z.A,z.B)
  L.AC     = line: new (z.A,z.C)
  L.BC     = line: new (z.B,z.C)
  C.OA     = circle: new (z.O,z.A)
  z.Ar,z.A1 = get_points (C.OA: tangent_at (z.A))
  z.Br,z.B1 = get_points (C.OA: tangent_at (z.B))
  z.Cr,z.C1 = get_points (C.OA: tangent_at (z.C))
  L.tA     = line: new (z.Ar,z.A1)
  L.tB     = line: new (z.Br,z.B1)
  L.tC     = line: new (z.Cr,z.C1)
  z.P      = intersection (L.tA,L.BC)
  z.Q      = intersection (L.tB,L.AC)
  z.R      = intersection (L.tC,L.AB)
}
\begin{tikzpicture}[scale= 1.6]
  \tkzGetNodes
  \tkzDrawPolygon[teal](A,B,C)
  \tkzDrawCircle(O,A)
  \tkzDrawPoints(A,B,C,P,Q,R)
  \tkzLabelPoints(A,B,C,P,Q,R)
  \tkzDrawLine[blue](Q,R)
  \tkzDrawLines[red](Ar,A1 Br,Q Cr,C1)
  \tkzDrawSegments(A,R C,P C,Q)
\end{tikzpicture}

```

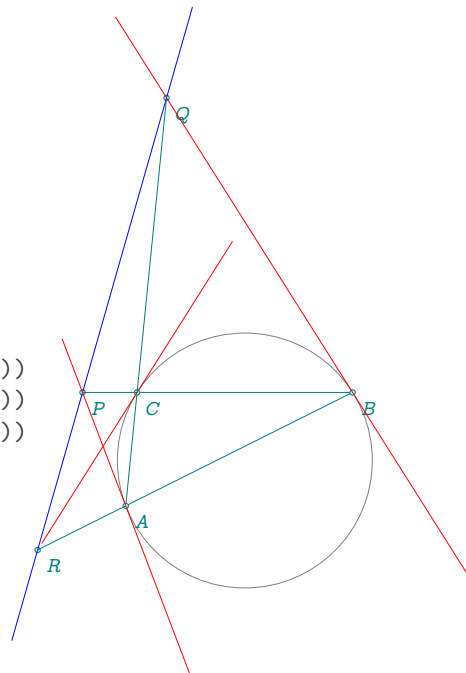

26.51 First Lemoine circle

Draw lines through the symmedian point L and parallel to the sides of the triangle. The points where the parallel lines intersect the sides of the triangle then lie on a circle known as the first Lemoine circle. It has center at the Brocard midpoint, i.e., the midpoint of $[OL]$, where O is the circumcenter and K is the symmedian point [Weisstein, Eric W. "First Lemoine Circle." From MathWorld—A Wolfram Web Resource.]

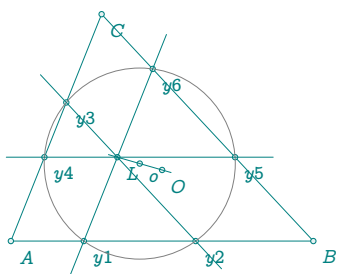

```

\directlua{%
init_elements ()
z.A = point: new (1,1)
z.B = point: new (5,1)
z.C = point: new (2.2,4)
T = triangle:new(z.A,z.B,z.C)
z.O = T.circumcenter
C.first_lemoine = T:first_lemoine_circle()
z.o,z.w = get_points( C.first_lemoine )
z.y1,z.y2= intersection (T.ab,C.first_lemoine)
z.y5,z.y6= intersection (T.bc,C.first_lemoine)
z.y3,z.y4= intersection (T.ca,C.first_lemoine)
z.L = T:lemoine_point ()
\begin{tikzpicture}
\tkzGetNodes
\tkzDrawPolygons(A,B,C)
\tkzDrawPoints(A,B,C,o,O,L,y1,y2,y3,y4,y5,y6)
\tkzLabelPoints(A,B,C,o,O,L,y1,y2,y3,y4,y5,y6)
\tkzDrawCircles(o,w)
\tkzDrawLines(y1,y6 y5,y4 y2,y3 O,L)
\end{tikzpicture}

```

26.52 First and second Lemoine circles

Draw antiparallels through the symmedian point L . The points where these lines intersect the sides then lie on a circle, known as the cosine circle (or sometimes the second Lemoine circle). Refer to [26.54]

[Weisstein, Eric W. "Cosine Circle." From MathWorld—A Wolfram Web Resource.]

```

\directlua{%
init_elements ()
z.a = point: new (0,0)
z.b = point: new (5,0)
z.c = point: new (2,3)
T = triangle: new (z.a,z.b,z.c)
z.O = T.circumcenter
z.o,z.p = get_points (T : first_lemoine_circle ())
L.ab = line : new (z.a,z.b)
L.ca = line : new (z.c,z.a)
L.bc = line : new (z.b,z.c)
z.L,z.x = get_points (T : second_lemoine_circle ())
C.first_lemoine = circle : new (z.o,z.p)
z.y1,z.y2 = intersection (L.ab,C.first_lemoine)
z.y5,z.y6 = intersection (L.bc,C.first_lemoine)
z.y3,z.y4 = intersection (L.ca,C.first_lemoine)
C.second_lemoine= circle : new (z.L,z.x)
z.x1,z.x2 = intersection (L.ab,C.second_lemoine)
z.x3,z.x4 = intersection (L.bc,C.second_lemoine)
z.x5,z.x6 = intersection (L.ca,C.second_lemoine)
L.y1y6 = line : new (z.y1,z.y6)
L.y4y5 = line : new (z.y4,z.y5)
L.y2y3 = line : new (z.y2,z.y3)
}
\begin{tikzpicture}[scale = 1.5]
\tkzGetNodes
\tkzDrawPolygons(a,b,c y1,y2,y3,y4,y5,y6)
\tkzDrawPoints(x1,x2,x3,x4,x5,x6,L)

```

```

\tkzDrawPoints(a,b,c,o,0,y1,y2,y3,y4,y5,y6)
\tkzLabelPoints[below right](a,b,c,o,0,y1,y2,y3,y4,y5,y6)
\tkzLabelPoints[below left](x1,x2,x3,x4,x5,x6)
\tkzLabelPoints[above](L)
\tkzDrawCircles(L,x o,p 0,a)
\tkzDrawSegments(L,0 x1,x4 x2,x5 x3,x6)
\end{tikzpicture}

```

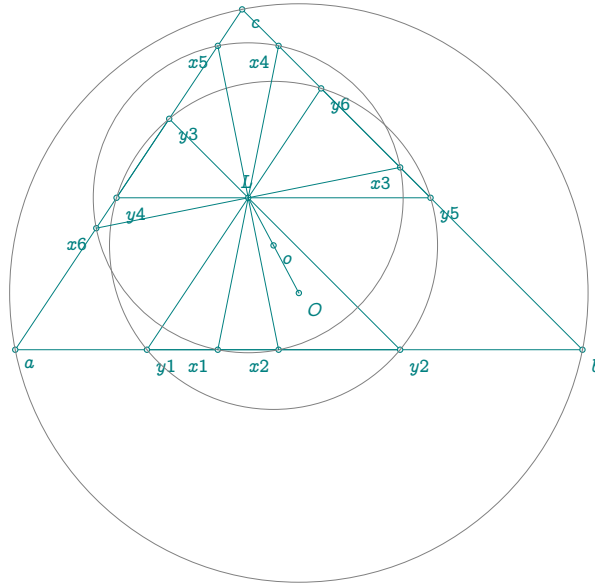

26.53 Inversion

```

\directlua{%
init_elements ()
z.A = point: new (-1,0)
z.B = point: new (2,2)
z.C = point: new (2,4)
z.E = point: new (1,6)
C.AC = circle: new (z.A,z.C)
L.Tt1,
L.Tt2 = C.AC: tangent_from (z.E)
z.t1 = L.Tt1.pb
z.t2 = L.Tt2.pb
L.AE = line: new (z.A,z.E)
z.H = L.AE : projection (z.t1)
z.Bp,
z.Ep,
z.Cp = C.AC: inversion ( z.B, z.E, z.C )
}

```

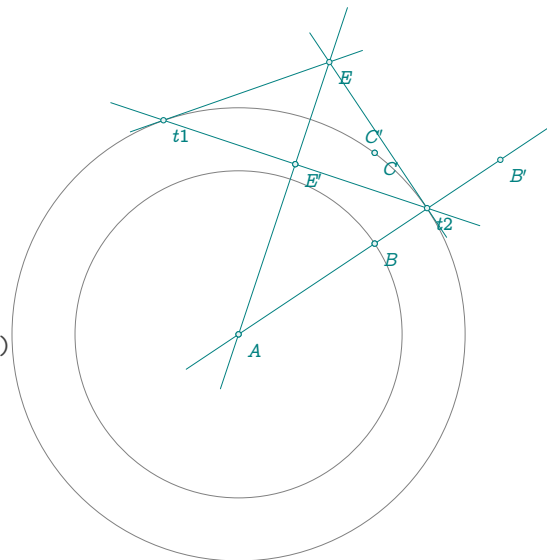

```

\begin{tikzpicture}[scale = .5]
\tkzGetNodes
\tkzDrawPoints(A,B,C)
\tkzDrawCircles(A,C A,B)
\tkzDrawLines(A,B' E,t1 E,t2 t1,t2 A,E)
\tkzDrawPoints(A,B,C,E,t1,t2,H,B',E')
\tkzLabelPoints(A,B,C,E,t1,t2,B',E')
\tkzLabelPoints[above](C')
\end{tikzpicture}

```

26.54 Antiparallel through Lemoine point

```

\directlua{%
init_elements ()
  z.a      = point: new (0,0)
  z.b      = point: new (5,0)
  z.c      = point: new (1,4)
  T        = triangle: new (z.a,z.b,z.c)
  z.L      = T : lemoine_point ()
  L.anti   = T : antiparallel (z.L,0)
  z.x_0,z.x_1 = get_points (L.anti)
  L.anti   = T : antiparallel (z.L,1)
  z.y_0,z.y_1 = get_points (L.anti)
  L.anti   = T : antiparallel (z.L,2)
  z.z_0,z.z_1 = get_points (L.anti)
}

\begin{tikzpicture}
  \tkzGetNodes
  \tkzDrawPolygons(a,b,c)
  \tkzDrawPoints(a,b,c,L,x_0,x_1,y_0,y_1,z_0,z_1)
  \tkzLabelPoints(a,b)
  \tkzLabelPoints[above](L,c)
  \tkzDrawSegments(x_0,x_1 y_0,y_1 z_0,z_1)
  \tkzDrawCircle(L,x_0)
\end{tikzpicture}

```

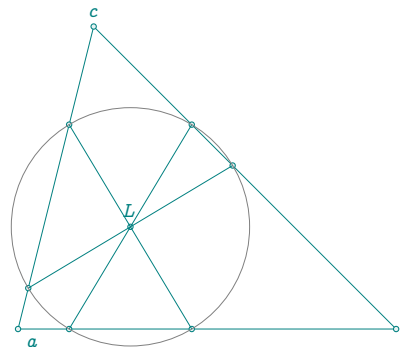

26.55 Pappus chain

```

\directlua{%
init_elements ()
  xC,nc    = 10,16
  xB        = xC/tkzphi
  xD        = (xC*xC)/xB
  xJ        = (xC+xD)/2
  r         = xD-xJ
  z.A       = point : new ( 0 , 0 )
  z.B       = point : new ( xB , 0 )
  z.C       = point : new ( xC , 0 )
  L.AC      = line : new (z.A,z.C)
  z.i       = L.AC.mid
  L.AB      = line:new (z.A,z.B)
  z.j       = L.AB.mid
  z.D       = point : new ( xD , 0 )
  C.AC      = circle: new (z.A,z.C)
  for i     = -nc,nc do
    z["J"..i] = point: new (xJ,2*r*i)
    z["H"..i] = point: new (xJ,2*r*i-r)
    z["J"..i.."p"], z["H"..i.."p"] = C.AC : inversion (z["J"..i],z["H"..i])
    L.AJ      = line : new (z.A,z["J"..i])
    C.JH      = circle: new ( z["J"..i] , z["H"..i])
    z["S"..i], z["T"..i] = intersection (L.AJ,C.JH)
    z["S"..i.."p"], z["T"..i.."p"] = C.AC : inversion (z["S"..i],z["T"..i])
    L.SpTp    = line:new ( z["S"..i.."p"], z["T"..i.."p"])
    z["I"..i] = L.SpTp.mid
  end
}

```



```

\def\nc{\tkzUseLua{nc}}
\begin{tikzpicture}[ultra thin]
  \tkzGetNodes
  \tkzDrawCircle[fill=teal!20](i,C)
  \tkzDrawCircle[fill=PineGreen!60](j,B)
  \foreach \i in {-\nc,...,0,...,\nc} {
    \tkzDrawCircle[fill=teal]({I\i},{S\i'})
  }
\end{tikzpicture}

```

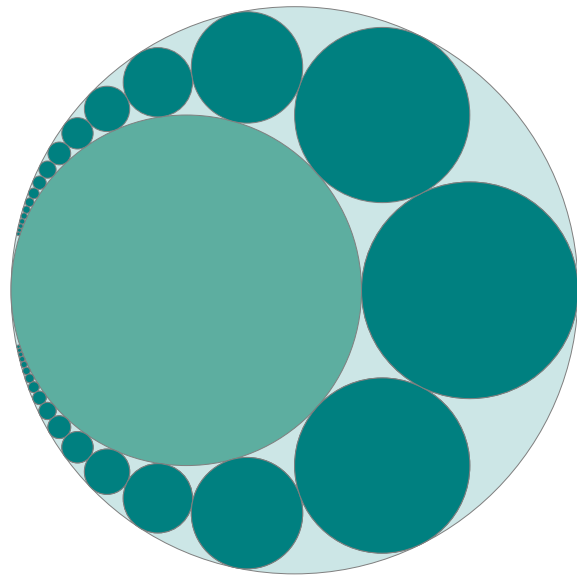

26.56 Three Circles

```

\directlua{%
init_elements ()
function threecircles(c1,r1,c2,r2,c3,h1,h3,h2)
  local xk = math.sqrt (r1*r2)
  local cx = (2*r1*math.sqrt(r2))/(math.sqrt(r1)+math.sqrt(r2))
  local cy = (r1*r2)/(math.sqrt(r1)+math.sqrt(r2))^2
  z[c2] = point : new ( 2*xk , r2 )
  z[h2] = point : new (2*xk,0)
  z[c1] = point : new (0,r1)
  z[h1] = point : new (0,0)
  L.h1h2 = line: new(z[h1],z[h2])
  z[c3] = point : new (cx,cy)
  z[h3] = L.h1h2: projection (z[c3])
end
threecircles("A",4,"B",3,"C","E","G","F")
}

\begin{tikzpicture}
  \tkzGetNodes
  \tkzDrawSegment[color = red](E,F)
  \tkzDrawCircle[orange,fill=orange!20](A,E)
  \tkzDrawCircle[purple,fill=purple!20](B,F)
  \tkzDrawCircle[teal,fill=teal!20](C,G)
\end{tikzpicture}

```

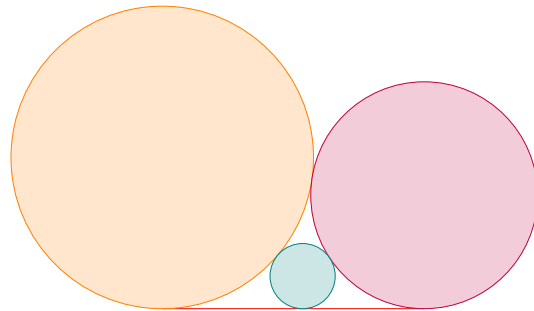

26.57 Pentagons in a golden arbelos

```

\directlua{%
init_elements ()
  z.A      = point: new ( 0 , 0)
  z.B      = point: new (10 , 0)
  L.AB     = line:  new ( z.A, z.B)
  z.C      = L.AB : gold_ratio ()
  L.AC     = line:  new ( z.A, z.C)
  L.CB     = line:  new ( z.C, z.B)
  z.O_0    = L.AB.mid
  z.O_1    = L.AC.mid
  z.O_2    = L.CB.mid
  C.O0B    = circle: new ( z.O_0, z.B)
  C.O1C    = circle: new ( z.O_1, z.C)
  C.O2B    = circle: new ( z.O_2, z.B)
  z.M_0    = C.O1C:external_similitude(C.O2B)
  L.O0C    = line:new(z.O_0,z.C)
  T.golden = L.O0C : golden ()
  z.L      = T.golden.pc
  L.O0L    = line:new(z.O_0,z.L)
  z.D      = intersection (L.O0L,C.O0B)
  L.DB     = line:new(z.D,z.B)
  z.Z      = intersection (L.DB,C.O2B)
  L.DA     = line:new(z.D,z.A)
  z.I      = intersection (L.DA,C.O1C)
  L.O2Z    = line:new(z.O_2,z.Z)
  z.H      = intersection (L.O2Z,C.O0B)
  C.BD     = circle:new (z.B,z.D)
  C.DB     = circle:new (z.D,z.B)
  _,z.G    = intersection (C.BD,C.O0B)
  z.E      = intersection (C.DB,C.O0B)
  C.GB     = circle:new (z.G,z.B)
  _,z.F    = intersection (C.GB,C.O0B)
  k        = 1/tkzphi^2
  kk       = tkzphi
  z.D_1,z.E_1,z.F_1,z.G_1 = z.B : homothety (k, z.D,z.E,z.F,z.G)
  z.D_2,z.E_2,z.F_2,z.G_2 = z.M_0 : homothety (kk,z.D_1,z.E_1,z.F_1,z.G_1)
}

\begin{tikzpicture}[scale=.8]
\tkzGetNodes
\tkzDrawPolygon[red] (O_2,O_0,I,D,H)
\tkzDrawPolygon[blue] (B,D_1,E_1,F_1,G_1)
\tkzDrawPolygon[green] (C,D_2,E_2,F_2,G_2)
\tkzDrawPolygon[purple] (B,D,E,F,G)
\tkzDrawCircles(O_0,B O_1,C O_2,B)
\tkzFillPolygon[fill=red!20,opacity=.20] (O_2,O_0,I,D,H)
\tkzFillPolygon[fill=blue!20,opacity=.20] (B,D_1,E_1,F_1,G_1)
\tkzFillPolygon[fill=green!60,opacity=.20] (C,D_2,E_2,F_2,G_2)
\tkzFillPolygon[fill=purple!20,opacity=.20] (B,D,E,F,G)
\tkzDrawCircles(O_0,B O_1,C O_2,B)
\tkzDrawSegments[new] (A,B)
\tkzDrawPoints(A,B,C,O_0,O_1,O_2,Z,I,H,B,D,E,F)
\tkzDrawPoints(D_1,E_1,F_1,G_1)
\tkzDrawPoints(D_2,E_2,F_2,G_2)
\tkzDrawPoints[red] (F_1)

```

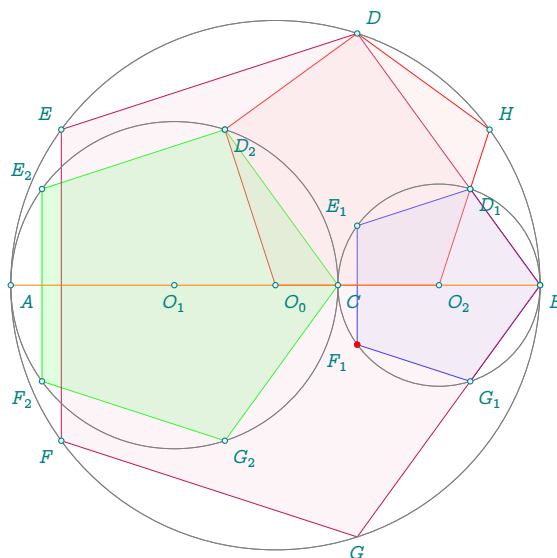

```
\tkzLabelPoints(A,B,C,O_0,O_2)
\tkzLabelPoints[below](O_1,G)
\tkzLabelPoints[above right](D,H)
\tkzLabelPoints[above left](E,E_1,E_2)
\tkzLabelPoints[below left](F,F_1,F_2)
\tkzLabelPoints(D_1,G_1)
\tkzLabelPoints(D_2,G_2)
\end{tikzpicture}
```

Index

attribute, 21

circle: attribute
 area, 57
 center, 57
 ct, 57
 east, 57
 north, 57
 opp, 57
 perimeter, 57
 radius, 57
 south, 57
 through, 57
 type, 57
 west, 57

circle: function
 diameter(A,B), 59
 new(O,A), 59
 radius(O,r), 59

circle: method
 antipode (pt), 59
 antipode, 61
 c_c_pp(pt,pt), 59
 c_c_pp, 79
 c_cc_p(C,pt), 59
 c_cc_p, 81
 c_lc_p(L,pt,<inside>), 59
 circles_position (C1), 59
 circles_position, 78
 common_tangent, 202
 common_tangent (C), 59
 commun_tangent, 69
 diameter, 60
 external_similitude (C), 59
 external_similitude, 65
 in_out (pt), 59
 in_out_disk (pt), 59
 in_out, 78
 internal_similitude (C), 59
 internal_similitude, 64
 inversion (obj), 59, 62
 is_tangent (L), 59
 is_tangent, 61
 midarc (pt,pt), 59
 midarc, 61
 midcircle (C), 59
 mmidcircle, 72
 new, 59
 orthogonal_from (pt), 59, 71
 orthogonal_through(pta,ptb), 59
 orthogonal_through, 72
 point (r), 59, 62
 polar(), 59
 polar(pt), 70
 power (pt), 59
 power(pt), 77
 radical_axis (C), 59
 radical_axis, 67
 radical_center (C1,C2), 66
 radical_center (C1<,C2>), 59
 radical_circle (C1<,C2>), 59
 radical_circle, 75
 radius, 60
 random_pt(lower, upper), 59
 tangent_at (P), 69
 tangent_at (pt), 59
 tangent_from (P), 69
 tangent_from (pt), 59

Class
 circle, 12, 57
 class, 28
 conic, 12, 117
 line, 12, 36
 matrix, 12, 158
 parallelogram, 12, 152
 point, 12, 29
 quadrilateral, 12, 145
 rectangle, 12, 149
 regular_polygon, 154
 regular_polygon, 12
 square, 12, 147
 triangle, 12, 84
 vector, 12, 155

conic: attribute
 Fa, 118
 Fb, 118
 K, 118
 Rx, 118
 Ry, 118
 a, 118
 b, 118
 covertex, 118
 c, 118
 directrix, 118
 e, 118
 major_axis, 118
 minor_axis, 118
 p, 118
 slope, 118
 subtype, 118
 type, 118
 vertex, 118

conic: method
 in_out (pt), 125
 in_out, 134
 new (pt, L, e), 125
 orthoptic_curve(), 125
 orthoptic, 134
 point (t), 125
 points (ta,tb,nb,sawp), 125
 points, 125
 point, 132
 tangent_at (pt), 125
 tangent_at, 128
 tangent_from (pt), 125
 tangent_from, 128
 tkzDrawCoordinates, 11

- tkzDrawPointOnCurve, 11
- \directlua, 16, 23
- Environment
 - luacode, 16
 - tikzpicture, 16, 20, 22
 - tkzelements, 11, 16, 23
- \foreach, 117
- line: attribute
 - east, 36
 - length, 36
 - mid, 36
 - north_pa, 36
 - north_pb, 36
 - pa, 36
 - pb, 36
 - slope, 36
 - south_pa, 36
 - south_pb, 36
 - type, 36
 - vec, 36
 - west, 36
- line: function
 - new(pt, pt), 38
- line: method
 - _east(d), 38
 - _north_pa(d), 38
 - _north_pb(d), 38
 - _south_pa(d), 38
 - _south_pb(d), 38
 - _west(d), 38
 - affinity_ll(L,k,pts), 39
 - affinity, 49
 - apollonius (r), 39
 - apollonius, 51
 - barycenter (r,r), 38
 - barycenter, 46
 - c_l_pp (pt,pt), 39
 - c_l_pp, 52
 - c_ll_p (pt,pt), 39
 - c_ll_p, 55
 - cheops (), 44
 - cheops (<swap>), 39
 - circle (), 39
 - colinear_at(pt,k), 38
 - colinear_at, 45
 - distance (pt), 38
 - distance, 39, 51
 - divine (), 44
 - divine (<swap>), 39
 - egyptian (<swap>), 39
 - equilateral (<swap>), 39
 - equilateral, 48
 - euclide (<swap>), 39
 - gold (<swap>), 39, 44
 - gold_ratio (), 38
 - golden (<swap>), 39, 44
 - golden_gnomon (<swap>), 39
 - half (<swap>), 39
 - harmonic_both (r), 38
 - harmonic_ext (pt), 38
 - harmonic_int (pt), 38
 - in_in_out_segment, 41
 - in_out (pt), 38
 - in_out_segment(pt), 38
 - in_out, 40, 186
 - is_equidistant(pt), 38
 - is_equidistant, 42
 - is_orthogonal(L), 38
 - is_orthogonal, 42
 - is_parallel(L), 38
 - is_parallel, 41
 - isis (<swap>), 39
 - isosceles (an<,swap>), 39
 - isosceles_a (an<,swap>), 39
 - isosceles_s (an<,swap>), 39
 - isosceles, 43
 - ll_from (pt), 38
 - ll_from, 47
 - mediator (), 38
 - mediator, 47
 - midpoint (), 38
 - new, 37
 - normalize (), 38
 - normalize_inv (), 38
 - normalize, 46
 - ortho_from (pt), 38
 - ortho_from, 47
 - point (r), 38
 - point, 45
 - projection (obj), 39
 - projection_ll(L,pts), 39
 - projection_ll, 49
 - projection, 48
 - pythagoras (), 44
 - pythagoras (<swap>), 39
 - reflection (obj), 39
 - reflection, 51
 - report(d,pt), 38
 - report, 42
 - sas (r,an<,swap>), 39
 - sas, 43
 - school (), 39
 - slope (), 38
 - square (), 39
 - ssa (r,an<,swap>), 39
 - ssa, 43
 - sss (r,r<,swap>), 39
 - sss, 43
 - sublime (), 44
 - sublime (<swap>), 39
 - translation (obj), 39
 - translation, 50
 - two_angles (an,an), 39
 - two_angles, 43
- lua: function
 - load, 24
- LuaTeX primitive
 - \directlua, 11, 25

- math: function
 - EL_bifocal , 138
 - EL_points , 138
 - HY_bifocal , 137
 - PA_dir , 136
 - PA_focus , 137
 - angle_normalize (an) , 167
 - get_angle (z1,z2,z3), 167
 - islinear (z1,z2,z3) , 167
 - isortho (z1,z2,z3), 167
 - length (a,b) , 167
 - real (v) , 167
 - solve_quadratic (a,b,c) , 167
 - tkzinvphi, 167
 - tkzphi, 167
 - tkzsqrtphi, 167
 - value (r) , 43
 - value (v) , 167
- math: method
 - aligned, 187
 - islinear, 186, 187
 - isortho, 186
- matrix: attribute
 - cols, 159
 - det, 159
 - rows, 159
 - set, 159
 - type, 159
- matrix: function
 - htm(), 161
 - new(...), 161
 - square(), 161
 - vector(), 161
- matrix: metamethod
 - __add(M1,M2), 160
 - __eq(M1,M2), 160
 - __mul(M1,M2), 160
 - __pow(M,n), 160
 - __sub(M1,M2), 160
 - __tostroing(M,n), 160
 - __unm(M), 160
- matrix: method
 - adjugate(), 161
 - adjugate, 165
 - get(), 161
 - get, 164
 - homogenization(), 161
 - htm_apply(...), 161
 - identity, 165
 - inverse(), 161
 - inverse, 164
 - is_diagonal(), 161
 - is_diagonal, 166
 - is_orthogonal(), 161
 - is_orthogonal, 166
 - print(s,n), 161
 - print, 163
 - transpose(), 161
 - transpose, 165
- misc: function
 - altitude (z1,z2,z3), 167
 - barycenter ({z1,n1},{z2,n2}, ...), 167
 - bisector (z1,z2,z3), 167
 - bisector_ext (z1,z2,z3), 167
 - midpoint (z1,z2), 167
 - midpoints (z1,z2,...,zn), 167
- obj: method
 - new, 28
- Object
 - circle, 28
 - conic, 28
 - line, 28, 38
 - parallelogram, 28
 - point, 28, 32
 - quadrilateral, 28
 - rectangle, 28
 - regular_polygon, 28
 - square, 28
 - triangle, 28
- occs: attribute
 - abscissa, 142
 - ordinate, 142
 - origin, 142
 - type, 142
 - x, 142
 - y, 142
- package: function
 - init_elements, 16
 - set_lua_to_tex (list), 167
- Packages
 - ifthen, 20, 185
 - tkz-elements, 11
- parallelogram: attribute
 - ab, 152
 - ac, 152
 - ad, 152
 - bc, 152
 - bd, 152
 - cd, 152
 - i, 152
 - pa, 152
 - pb, 152
 - pc, 152
 - pd, 152
 - type, 152
- parallelogram: method
 - fourth (za,zb,zc), 153
- point: attribute
 - argument, 29
 - im, 29
 - modulus, 29
 - mtx, 29, 30
 - re, 29
 - type, 29
- point: function
 - new(r,r), 32
 - polar (d,an), 32
 - polar_deg (d,an), 32
- point: metamethod
 - __add(z1,z2), 180

```

__concat(z1,z2), 180
__div(z1,z2), 180
__eq(z1,z2), 180
__mul(z1,z2), 180
__pow(z1,z2), 180
__sub(z1,z2), 180
__tonumber(z), 180
__tostring(z), 180
__unm(z), 180
point: method
  abs (z), 180
  arg (z), 180
  at (), 32
  at, 33
  conj(z), 180
  east(r), 32
  get(z), 180
  get_points (obj), 32
  homothety(r,obj), 32
  mod(z), 180
  norm (z), 180
  normalize (), 33
  normalize(), 32
  north (d), 32
  north(r), 32
  orthogonal (d), 32, 33
  polar, 32
  print(), 32
  rotation(an , obj), 32
  rotation, 34
  south(r), 32
  sqrt(z), 180
  symmetry(obj), 32
  symmetry, 35
  west(r), 32
prime, 20
quadrilateral: attribute
  ab, 145
  ac, 145
  ad, 145
  a, 145
  bc, 145
  bd, 145
  b, 145
  cd, 145
  c, 145
  d, 145
  g, 145
  i, 145
  pa, 145
  pb, 145
  pc, 145
  pd, 145
  type, 145
quadrilateral: method
  iscyclic (), 145
rectangle: attribute
  ab, 149
  ac, 149
  ad, 149
  bc, 149
  bd, 149
  cd, 149
  center, 149
  diagonal, 149
  length, 149
  pa, 149
  pb, 149
  pc, 149
  pd, 149
  type, 149
  width, 149
rectangle: method
  angle (zi,za,angle), 150
  diagonal (za,zc), 150
  get_lengths (), 150
  gold (za,zb), 150
  side (za,zb,d), 150
regular_polygon: method
  incircle (), 154
  name (string), 154
  new(O,A,n), 154
regular: attribute
  angle, 154
  center, 154
  circle, 154
  circumradius, 154
  inradius, 154
  proj, 154
  side, 154
  through, 154
  type, 154
  vertices, 154
square: attribute
  ab, 147
  ac, 147
  ad, 147
  bc, 147
  bd, 147
  cd, 147
  center, 147
  circumradius, 147
  inradius, 147
  pa, 147
  pb, 147
  pc, 147
  pd, 147
  proj, 147
  side, 147
  type, 147
square: method
  rotation (zi,za), 148
  side (za,zb), 148
table: method
  concat, 24
  insert, 24
tkz-elements: function
  init_elements, 11

```

- tkz-euclide: options
 - lua, 21
 - mini, 21
- \tkzDrawCoordinates, 118, 125
- \tkzGetNodes, 15, 16, 20, 23, 179
- \tkzUseLua(value), 24
- \tkzUseLua, 168
- triangle: attribute
 - ab, 84
 - alpha, 84
 - area, 84
 - a, 84
 - bc, 84
 - beta, 84
 - b, 84
 - ca, 84
 - centroid, 84
 - circumcenter, 84
 - circumradius, 84
 - c, 84
 - eulercenter, 84
 - gamma, 84
 - incenter, 84
 - inradius, 84
 - orthocenter, 84
 - pa, 84
 - pb, 84
 - pc, 84
 - semiperimeter, 84
 - spiekercenter, 84
 - type, 84
- triangle: method
 - Nagel_point, 88
 - altitude (n) , 86
 - altitude, 94
 - anti () , 87
 - antiparallel(pt,n), 86
 - anti, 106
 - area () , 86
 - barycentric (ka,kb,kc), 86
 - barycentric_coordinates(pt), 86
 - barycentric_coordinates, 91
 - base (u,v) , 86
 - base, 92
 - bevan_circle (), 87
 - bevan_circle, 101
 - bevan_point () , 86
 - bevan_point, 101
 - bisector (n) , 86
 - bisector_ext(n) , 86
 - bisector, 94
 - brocard_axis(), 86
 - brocard_axis, 115
 - c_ll_p (pt), 87
 - c_ll_p, 111
 - cevian (pt), 87
 - cevian_circle (), 87
 - cevian_circle, 98
 - cevian, 98
 - check_acutangle () , 86
 - check_equilateral () , 86
 - circum_circle (), 87
 - circum_circle, 95
 - contact () , 87
 - contact, 87
 - conway_circle (), 87
 - conway_circle, 100
 - conway_points, 100
 - euler (), 87
 - euler_circle (), 87
 - euler_circle, 95
 - euler_ellipse (), 87
 - euler_line () , 86
 - euler_line, 106
 - euler_points(), 86
 - euler_points, 92
 - ex_circle (n), 87
 - ex_circle, 97
 - excentral () , 87
 - extouch () , 87
 - fermat_axis(), 86
 - fermat_axis, 115
 - feuerbach () , 87
 - feuerbach_point () , 86
 - feuerbach_point, 101
 - feuerbach, 101
 - first_lemoine_circle (), 87
 - gergonne_point () , 86
 - gergonne_point, 87
 - in_circle (), 87
 - in_circle, 96
 - in_out (pt), 86
 - incentral () , 87
 - incentral, 94, 103
 - intouch () , 87
 - intouch, 87
 - kimberling (n), 86
 - kimberling, 90
 - lemoine_axis(), 86
 - lemoine_axis, 114
 - lemoine_point () , 86
 - medial () , 87
 - medial, 102
 - mittenpunkt_point () , 86
 - mittenpunkt, 88
 - nagel_point () , 86
 - new, 84, 86
 - nine_points(), 86
 - nine_points, 93
 - orthic () , 87
 - orthic_axis_points, 106
 - orthic_axis, 106
 - orthic, 94
 - parallelogram(), 86
 - pedal (pt), 87
 - pedal_circle () , 87
 - pedal_circle, 99
 - pedal, 99
 - projection (p), 86
 - projection, 89
 - second_lemoine_circle () , 87
 - similar () , 87

similar, 102
simson_line(pt), 86
simson_line, 113
spieker_center (), 86
spieker_circle (), 87
spieker_circle, 98
steiner_circumellipse (), 87
steiner_inellipse (), 87
steiner_line(pt), 86
steiner_line, 112
symmedial (), 87
symmedial_circle (), 87
symmedial, 105
symmedian_line (n), 86
symmedian_point (), 86
tangential (), 87
tangential, 104
taylor_circle (), 87
taylor_circle, 115
taylor_points(), 86
trilinear (u,v,w) ,86
trilinear, 91
underscore, 21
vector: attribute
 head, 155
 length, 155
 mtx, 155
 slope, 155
 tail, 155
 type, 155
vector: method
 __add (u,v), 156
 __mul (k,u), 156
 __sub (u,v), 156
 __unm (u), 156
 at (V), 156
 new(pt, pt), 156
 normalize(V), 156
 orthogonal(d), 156
 scale(d), 156

27 Cheat_sheet

r denotes a real number, cx complex number, d a positive real number, n an integer, an an angle, b a boolean, s a character string, p a point, t a table, m a matrix, v variable, L a straight line, C a circle, T a triangle, E an ellipse, V a vector, Q a quadrilateral, P a parallelogram, R a rectangle, S a square, RP a regular polygon, M a matrix, O an object (p, L,C,T), . . . a list of points or an object, <> optional argument.

point		vec	-> V	golden (<swap>)	-> T
Attributes table(1)				divine ()	-> T
re	-> r	Methods table(6)		cheops ()	-> T
im	-> r	new (p,p)	-> d	pythagoras ()	-> T
type	-> s	distance (p)	-> d	sublime ()	-> T
argument	-> r	slope ()	-> r	egyptian ()	-> T
modulus	-> d	in_out (p)	-> b	square (<swap>)	-> T
		in_out_segment (p)	-> b		
Functions table(1)		is_parallel (l)	-> b	triangle	
new	-> p	is_orthogonal (l)	-> b	Attributes table(9)	
polar	-> p	is_equidistant (p)	-> b	pa,pb,pc	-> p
polar_deg	-> p	barycenter (r,r)	-> p	circumcenter	-> p
		point (t)	-> p	centroid	-> p
Methods table(30)		midpoint ()	-> p	incenter	-> p
+ - * / (p,p)	-> p	harmonic_int (p)	-> p	eulercenter	-> p
.. (p,p)	-> r	harmonic_ext (p)	-> p	orthocenter	-> p
^ (p,p)	-> r	harmonic_both (d)	-> p	spiekercenter	-> p
=	-> b	gold_ratio()	-> p	type	-> s
tostring	-> s	normalize ()	-> p	a	-> d
		normalize_inv ()	-> p	b	-> d
Methods table(2) table(31)		_north_pa (d)	-> p	c	-> d
conj	-> p	_north_pb (d)	-> p	ab	-> L
abs	-> r	_south_pa (d)	-> p	bc	-> L
mod	-> d	_south_pb (d)	-> p	ca	-> L
norm	-> d	_east (d)	-> p	alpha	-> r
arg	-> d	_west (d)	-> p	beta	-> r
get	-> r,r	report (r,p)	-> p	area	-> r
sqrt	-> p	colinear_at (p,k)	-> p	semiperimeter	-> r
north(d)	-> p	affinity (p)	-> P	inradius	-> r
south(d)	-> p	affinity (pts)	-> pts	circumradius	-> r
east(d)	-> p	projection (pts)	-> pts		
west(d)	-> p	projection_ll (pts)	-> pts	Methods table(10)	
normalize(p)	-> p	translation (...)	-> O	new (p,p,p)	-> T
symmetry (...)	-> O	reflection (...)	-> O	check_equilateral ()	-> b
rotation (an , ...)	-> O	ll_from (p)	-> L	in_out (p)	-> b
homothety (r , ...)	-> O	ortho_from (p)	-> L	area ()	-> d
orthogonal(d)	-> p	mediator ()	-> L	parallelogram ()	-> p
at()	-> p	swap_line ()	-> L	trilinear (r,r,r)	-> p
print()	-> s	circle ()	-> C	barycentric (r,r,r)	-> p
		circle_swap ()	-> C	bevan_point ()	-> p
line		diameter ()	-> C	mittenpunkt_point ()	-> p
Attributes table(3)		apollonius (r)	-> C	gergonne_point ()	-> p
pa,pb	-> p	c_ll_p (p,p)	-> C	nagel_point ()	-> p
type	-> s	c_l_pp (p,p)	-> C	feuerbach_point ()	-> p
mid	-> p	equilateral (<swap>)	-> T	lemoine_point()	-> p
north_pa	-> p	isosceles (an,<swap>)	-> T	symmedian_point()	-> p
north_pb	-> p	school ()	-> T	spieker_center()	-> p
south_pa	-> p	two_angles (an,an)	-> T	barycenter (r,r,r)	-> p
south_pb	-> p	half ()	-> T	base (u,v)	-> p
east	-> p	sss (r,r,r)	-> T	euler_points ()	-> p
west	-> p	sas (r,an)	-> T	nine_points ()	-> p
slope	-> r	ssa (r,an)	-> T	point (t)	-> p
length	-> d	gold (<swap>)	-> T	soddy_center ()	-> p
		euclide (<swap>)	-> T		

isogonal (p)	-> p	radius (p, r)	-> C	asymptotes (r))	-> L
conway_points ()	-> pts	diameter (p,p)	-> C	orthoptic ()	-> L,Co
projection (p)	-> p,p,p	in_out (p)	-> b	antipode (p)	-> p
euler_line ()	-> L	in_out_disk (p)	-> b		
symmedian_line (n)	-> L	circles_position (C)	-> s	Functions 13.9	
altitude (n)	-> L	power (p)	-> r	EL_points (p,p,p)	-> p,L,r
bisector (n)	-> L	antipode (p)	-> p	EL_bifocal(p,p,r or p)	-> p,L,r
bisector_ext(n)	-> L	midarc (p,p)	-> p	HY_bifocal(p,p,r or p)	-> p,L,r
antiparallel(p,n)	-> L	point (r)	-> p	PA_dir(p,p,p)	-> p,L,r
brocard_axis ()	-> L	random_pt (lower, upper)	-> p	PA_focus(L,p,p)	-> p,L,r
simson_line (p)	-> L	internal_similitude (C)	-> p		
steiner_line (p)	-> L	external_similitude (C)	-> p	occs	
euler_line ()	-> L	radical_center(C,<C>)	-> p	Attributes table(13)	
fermat_axis (p)	-> L	taylor_points()	-> pts	L,p	-> occs
lemoine_axis ()	-> L	tangent_at (p)	-> L	type	-> s
euler_circle ()	-> C	radical_axis (C)	-> L	origin	-> p
circum_circle()	-> C	polar (p)	-> L	y	-> p
in_circle ()	-> C	radical_circle(C,<C>)	-> C	x	-> p
ex_circle (n)	-> C	orthogonal_from (p)	-> C	abscissa	-> L
first_lemoine_circle()	-> C	orthogonal_through(p,p)	-> C	ordinate	-> L
second_lemoine_circle()	-> C	c_lc_p (L,p,inside)	-> C		
spieker_circle()	-> C	c_c_pp(a,b)(p,p)	-> C	Methods table(19)	
soddy_circle ()	-> C	c_cc_p (C,p)	-> C	new (L,p)	-> R
conway_circle ()	-> C	midcircle(C)	-> C	coordinates (p)	-> r,r
pedal_circle ()	-> C	taylor_circle()	-> C		
cevian_circle ()	-> C	external_tangent(C)	-> L,L	square	
c_ll_p (p)	-> C	internal_tangent(C)	-> L,L	Attributes table(16)	
orthic()	-> T	common_tangent(C)	-> L,L	pa,pb,pc,pd	-> p
medial()	-> T	tangent_from (p)	-> L,L	type	-> s
incentral()	-> T	inversion (...)	-> 0	side	-> d
excentral()	-> T			center	-> p
intouch()	-> T	conic		circumradius	-> d
contact()	-> T	Attributes table(11)		inradius	-> d
extouch()	-> T	center	-> p	diagonal	-> d
feuerbach()	-> T	vertex	-> p	proj	-> p
anti ()	-> T	covertex	-> p	ab bc cd da	-> L
tangential ()	-> T	Fa	-> p	ac bd	-> L
cevian (p)	-> T	Fb	-> p	Methods table(17)	
symmedian ()	-> T	center	-> p	new (p,p,p,p)	-> S
euler ()	-> T	K	-> p	rotation (p,p)	-> S
pedal (p)	-> T	e	-> r	side (p,p,<swap>)	-> S
barycentric_coordinates(p)	-> r,r,r	a	-> r		
-> r,r,r		b	-> r	rectangle	
circle		c	-> r	Attributes table(18)	
Attributes table(7)		h	-> r	pa,pb,pc,pd	-> p
center	-> p	p	-> r	type	-> s
through	-> p	Rx	-> d	center	-> p
north	-> p	Ry	-> d	circumradius	-> d
south	-> p	slope	-> r	length	-> r
east	-> p	type	-> s	width	-> r
west	-> p	subtype	-> s	diagonal	-> d
opp	-> p	major_axis	-> L	ab bc cd da	-> L
type	-> s	minor_axis	-> L	ac bd	-> L
radius	-> d	Methods table(12)		Methods table(19)	
ct	-> L	new (p,L,r)	-> E	new (p,p,p,p)	-> R
perimeter	-> r	points (r,r,n,< swap >)	-> E	angle (p,p,an)	-> R
area	-> r	point (r,< swap >)	-> E	gold (p,p,<swap>)	-> R
Methods table(8)		in_out (p)	-> b	diagonal (p,p,<swap>)	-> R
new (p,p)	-> C	tangent_at (p)	-> L	side (p,p,r,<swap>)	-> R
		tangent_from (p)	-> L		

get_lengths ()	->r,r	Methods table(23)	print	-> s
quadrilateral		new (p,p,n)	get	-> r/cx
Attributes table(14)		incircle ()	inverse	-> m
pa,pb,pc,pd	-> p	name (s)	adjugate	-> m
ab bc cd da	-> L	vector	transpose	-> m
ac bd	-> L	Attributes table(24)	is_diagonal	-> b
type	-> s	type	is_orthogonal	-> b
i	-> p	norm	homogenization	-> m
g	-> p	slope	htm_apply	-> m
a b c d	-> r	mtx	Misc.	
Methods table(15)		Methods table(25)	Attributes table(29)	
new (p,p,p,p)	-> Q	new (p,p)	scale (default =1)	-> r
iscyclic ()	-> b	+ - *	tkzphi	-> r
parallelogram		normalize (V)	tkzinvphi	-> r
Attributes table(20)		orthogonal (d)	tkzsqrtphi	-> r
pa,pb,pc,pd	-> p	scale (r)	tkz_epsilon (default=1e-	
ab bc cd da	-> L	at (p)	8) -> r	
ac bd	-> L	matrix	length	-> d
type	-> s	Attributes table(26)	islinear(p,p,p)	-> b
center	-> p	set	isortho(p,p,p)	-> b
Methods table(21)		rows	value{r}	-> r
new (p,p,p,p)	->P	cols	real	-> r
fourth (p,p,p)	->P	type	angle_normalize (an)	-> an
Regular_polygon		det	barycenter (...)	-> p
Attributes table(22)		Functions table(28)	bisector (p,p,p)	-> L
center	-> p	new	bisector_ext (p,p,p)	-> L
through	-> p	square	altitude (p,p,p)	-> L
circle	-> C	htm	midpoint (p,p)	-> p
type	-> s	vector	midpoints (...) -> list of pts	
side	-> d	Metamethods table(27)	equilateral (p,p)	-> T
circumradius	-> d	+ - * (m,m)	format_number(r,n)	-> r
inradius	-> d	^ (m,n)	solve_quadratic(cx,cx,cx)->cx,cx	
proj	-> p	=	\tkzUseLua{v}	-> s
nb	-> i	tostring	Macros	
angle	-> an	Method table(28)	\tkzDN[n]{r}	-> r
			\tkzDrawLuaEllipse(p,p,p)	